

<b>CONTENS :</b>	<b>Page</b>
1. GENERAL	2
1.1 MARKING OF THER BOILER	2
1.2 BOILER CONSTRUCTION	2
1.3 REGULATORY AND SECURITY ELEMENTS	4
1.3.1 BOILER CONTROLLER	4
1.3.2 MIXING VALVE	6
1.3.3 EXHAUST FAN, SECURITY EXCHANGER AGAINST OVERHEATING	7
1.3.4 SETTING OF PRIMARY AND SECONDARY AIR SUPPLY	8
2. TECHNICAL DATA	9
2.1 MAIN DIMENSIONS	9
2.2 TECHNICAL DATA TABLE	9
2.3 SUPPLIED AND REQUIRED ACCESSORIES	10
3. BOILERS INSTALLATION	10
3.1 RELATED LEGISLATION	10
3.2 BOILER PLACING	10
3.3 CONNECTING TO HEATING SYSTEM	11
3.4 CONNECTING TO THE CHIMNEY	11
3.5 ELECTRICAL WIRING SCHEMA	12
4. BOILER OPERATION AND MAINTENANCE	12
4.1 PUTTING THE BOILER INTO OPERATION	12
4.2 OPERATION OF THE CONTROL REGULATOR	14
4.2.1 DESCRIPTION	14
4.2.2 FUNKTIONS OF THE REGULATOR	15
a) Initial panel	15
b) Begin of firing in the boiler	15
c) Manual control	16
d) Settings of temperature of pumps activation	17
e) Hysteresis of central heating (boiler)	17
f) Hysteresis of warm water	17
g) Fan speed	18
h) Activation of hot water pump - boiler priority	18
i) Indoor regulator	19
j) Summer mode	19
k) Ventilation time and ventilation break of the combustion chamber.	19
l) Constant running of central heating pump	20
m) Language	20
n) Week schedule	20
o) Base set-up	21
4.2.3 PROTECTION	21
a) Thermal protection	21
b) Automatic probe control	22
c) Protection against yeast water in the boiler	22
d) Heat protection	22
e) Fuse	22
4.2.4 REGULATOR MAINTENANCE	22
4.2.5 TECHNICAL PARAMETERS OF REGULATOR	23
4.2.6 INSTALLATION	23
4.3 RANGE OF WORKS FOR THE ANNUAL INSPEKTION AND MAINTENANCE	23
4.4 USER SERVICING OF BOILER	23
4.5 REGULAR MAINTENANCE	25
4.6 REMOVING OF THE COVER TOP	25
5. SAFETY AND FIRE MEASURES	25
6. DISPOSAL OF THE PRODUCT AFTER END OF LIFE	27
7. WARRANTY CONDITIONS	27
8. POSSIBLE FAILURE AND ITS REPAIRING	28
9. DECLARATION OF CONFORMITY	30
10. WARRANTY AND CERTIFICATE OF QUALITY AND COMPLETENESS	31
11. RECORD OF MAINTENANCE AND REPAIR	32
12. RECOMMENDED SCHEME FOR CONNECTION OF THE BOILER	33

Dear customer,

thank you that you have chosen to purchase our product. We believe that its parameters, performance and operational reliability will be used by you to maximum satisfaction. The instructions we would like to serve useful tips that are essential to the flawless operation of the boiler. Manual also contains detailed instructions and information for the installation. Keep it carefully, so you have it, if necessary, whenever available.

Yours truly: 

## 1. GENERAL

### 1.1 INDICATION OF THE BOILER

**ZEUS MODRATHERM PYRO 15** is a steel hot water boiler for pyrolytic wood burning for central heating in buildings with a rated output of 14.9 kW and a maximum operating pressure of 0.25 MPa. These boilers are equipped with safety heat exchanger against overheating.

**ZEUS MODRATHERM PYRO 20** is a steel hot water boiler for pyrolytic wood burning for central heating in buildings with a rated output of 20 kW and a maximum operating pressure of 0.25 MPa. These boilers are equipped with safety heat exchanger against overheating.

**ZEUS MODRATHERM PYRO 26** is a steel hot water boiler for pyrolytic wood burning for central heating in buildings with a rated output of 26 kW and a maximum operating pressure of 0.25 MPa. These boilers are equipped with safety heat exchanger against overheating.

**ZEUS MODRATHERM PYRO 30** is a steel hot water boiler for pyrolytic wood burning for central heating in buildings with a rated output of 30 kW and a maximum operating pressure of 0.25 MPa. These boilers are equipped with safety heat exchanger against overheating.

**ZEUS MODRATHERM PYRO 36** is a steel hot water boiler for pyrolytic wood burning for central heating in buildings with a rated output of 36 kW and a maximum operating pressure of 0.25 MPa. These boilers are equipped with safety heat exchanger against overheating.

**ZEUS MODRATHERM PYRO 42** is a steel hot water boiler for pyrolytic wood burning for central heating in buildings with a rated output of 42 kW and a maximum operating pressure of 0.25 MPa. These boilers are equipped with safety heat exchanger against overheating.

### 1.2 BOILER CONSTRUCTION

Boilers MODRATHERM ZEUS PYRO are designed for burning wood with a water content of 20% with a maximum length of up to 550 mm.

Burning wood is subjected to high temperatures on the principle of gasification. The boiler body is made from high quality steel sheet thickness 5 mm (walls of the combustion chamber in contact with flame and water) and a thickness of 3 mm (sides, in contact with water only). A part of water circle are the two latches at the top of the boiler body. Insulation cover is made of steel sheet thickness 0.8 mm and painted with powder colour. Insulation is mineral wool. Primary air is supplied to the boiler through a flap in front of the boiler. Secondary air is supplied to the chamber nozzle from the rear bottom part through channels in the firebeton combustion chamber and is controlled with a flap, which is located at the rear bottom part of the boiler. At the bottom of the loading area are blocks of refractory concrete. Segmental ceramic combustion chamber is located at the rear of the boiler and reaches to the water lamellas. Combustion chamber and nozzle chamber are made of blocks of refractory concrete (ceramics) with high thermal and mechanical resistance. Combustion chamber is protected against damage with a steel plate. Modern design of the heat transfer surface area and the combustion chamber ensures perfect combustion with high efficiency and low production of harmful substances in exhaust gas. At the bottom of the firing area are solid cast iron gratings, through which the ash is falling in an ashtray. Ashtray is in a separate section of the boiler separated with the doors. The construction of boilers ZEUS PYRO ensure to achieve a sufficiently high temperature in the combustion chamber, as well as sufficient time to keep combustible gas in the boiler until they are completely burned. In the boilers is built integrated copper heat

exchanger, which provides a protective function against boiler overheating. The boiler is equipped with an exhaust flue gas fan, which ensures easy operation and minimizes fumigation of the boiler space. The operation of the boiler is controlled by a microprocessor controller. The boiler can be connected to the heating system of threaded connections G 6 / 4. Connecting socket of the security exchanger is made with threads G 1 / 2 ".

#### Advantages of the boilers MODRATHERM ZEUS PYRO:

- *primary and secondary air will overheated to a high temperature*
- *high burning efficiency - low fuel consumption*
- *enviromental burning - Low emission values - Class 3 according to STN EN 303-5*
- *integrated safety device against overheating*
- *exhaust fan automatically turns off when the fuel burns out*
- *large feeding place for wood - feeding interval in normal operation from 5 to 12 hours*
- *ash separate section separated from the combustion chamber - cleaning during operation of the boiler*
- *thermostatic control of the exhaust fan*
- *segment ceramic chamber with high heat and mechanical resistance covered by steel cover plated against damage*
- *built-in exhaust fan - to minimize the fumigation by feeding wood*
- *boiler controlled by microprocessor controller - comfort control and management of central heating and warm water*

#### Main parts of the boiler :

#### Key:

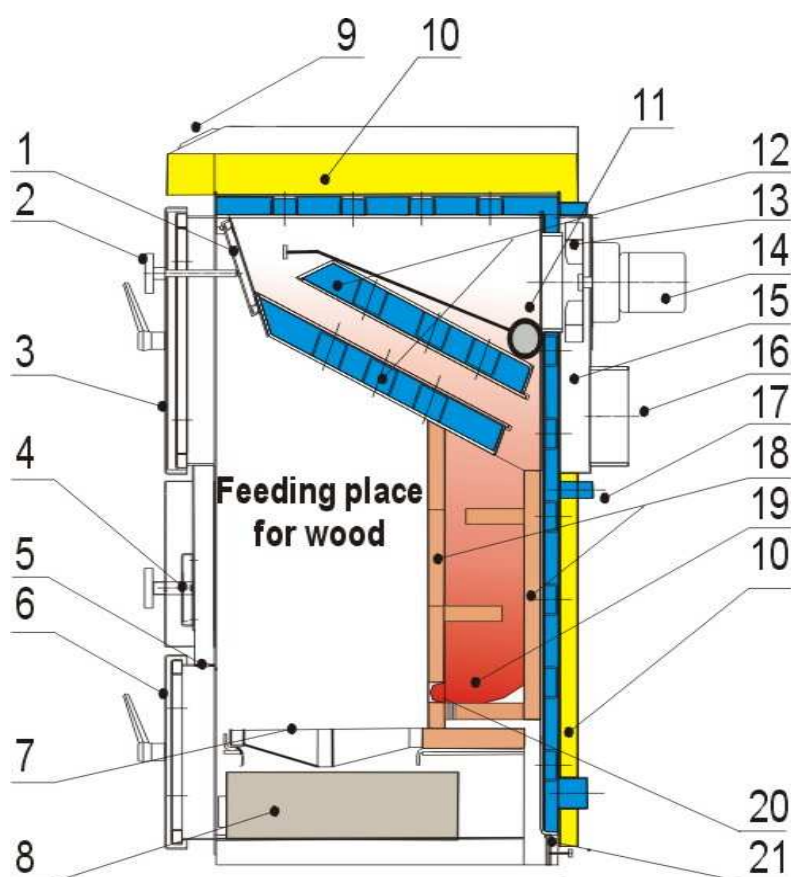

- 1 heating flap
- 2 handling of heating flap
- 3 feed door
- 4 main flap for primary air supply upper
- 5 flap for primary air supply bottom
- 6 ashtray door
- 7 cast iron grate
- 8 ashtray
- 9 microprocessor regulator
- 10 thermal insulation
- 11 flue rectifier (by cleaning take out through the heating flap 1)
- 12 cells of heating exchanger
- 13 exhaust fan propeller
- 14 exhaust fan
- 15 chamber for flue offtake
- 16 chimney diameter  $\phi$  152
- 17 connection hole G 1/2" of security heat exchanger
- 18 ceramic fireconcrete blocks LACFIRE
- 19 ceramic combustion chamber
- 20 combustion chamber jet
- 21 flap for sekundary air supply

## 1.3 REGULATORY AND SECURITY ELEMENTS



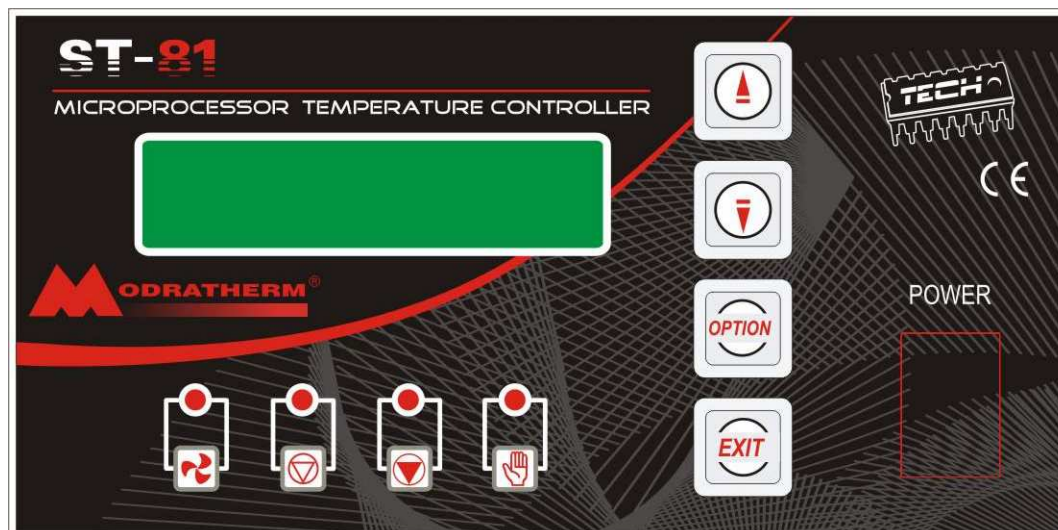

### 1.3.1 BOILER CONTROLLER

Each boiler is equipped with electronic controller, which provides greater comfort and control and access of control and security features. The higher meanings of the symbols and buttons are as follows.

#### Front view of the electronic controller - Control Panel:



#### • Button description

<b>POWER</b>	<ul style="list-style-type: none"> <li>- main switcher</li> <li>- boiler on and off</li> </ul>
	<ul style="list-style-type: none"> <li>- move downward in the menu</li> <li>- to reduce the values</li> </ul>
	<ul style="list-style-type: none"> <li>- move upwards in the menu</li> <li>- to increase the values</li> </ul>
	<ul style="list-style-type: none"> <li>- the entrance to the menu and submenu function</li> <li>- confirmation of the function</li> </ul>
	<ul style="list-style-type: none"> <li>- exit the menu, respectively from the submenu</li> <li>- on hold in the standby mode, enter the menu of warm water</li> </ul>

#### • Symbol description

The Control Panel shows 4 separate symbols. Part of each symbol is a LED indicating the current status.



- LED indicator for exhaust fan running
- If operation the LED indicator lights



- LED indicator for central heating pump running
- If operation the LED indicator lights



- LED indicator for warm water pump running
- If operation the LED indicator lights



- LED indicator for manually mode of exhaust fan
- If the fan is manually in operation the LED indicator lights

### Rear view of an electronic controller:

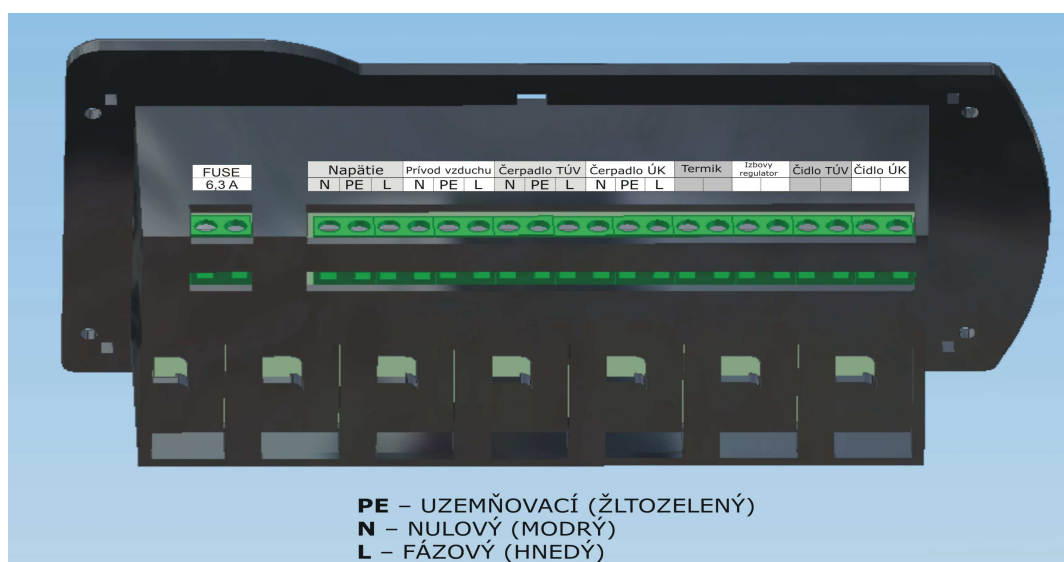

#### **Symbol**

Fuse 1,6A

#### **Function description**

- connection terminal for security fuse

Voltage

- connection terminals for power cord

Exhaust fan

- connection terminals for exhaust fan

Warm water pump

- connection terminals for warm water pump

Central heating pump

- connection terminals for central heating pump

Termik

- connection terminals for additional security thermostat (automatically return )

Indoor controller

- connection terminals for indoor controller

Warm water probe

- connection terminals for sensor of warm water

Central heating probe

- connection terminals for sensor of boiler thermostat

**WARNING!**

**Without using additional hydraulic and thermal regulation can significantly shorten the life of the boiler.**

Boiler heating water temperature can be controlled with boiler thermostat, which is part of the microprocessor controller. Boiler thermostat is a regulatory element, which can regulate the temperature of output water from the boiler and thus in a central heating system. Boiler thermostat temperature range is from 40 °C to 90 °C. Boiler thermostat is recommended to set, that the return water temperature of the heating system falls not below 65 °C, because under this temperature comes to condensation of water vapor, the formation of acid tar and the ter building in the boiler. At lower temperatures losses boiler can have thermal inertia, we therefore recommend to set boiler thermostat also at low ambient temperatures on maximum value of 85 °C, as close above this temperature may activate safety thermostat to shut down exhaust fan. Manually re-activate the safety thermostat can be lowered when the temperature of heating water decreases to about 70 °C and shutdown the alarm sound by pressing the MENU button.

Boilers MODRATHERM ZEUS PYRO are equipped with so-called minimum temperature thermostat, which switches off the fan when the water temperature drops below the boiler 50 °C. This will ensure the fan off automatically in case the attachment of the fuel will be carried out.

If there is any reason to repeat the shutdown of the boiler safety thermostat, it should call an authorized service worker who finds and removes the cause of the outage.

The boiler can be equipped with individual room thermostat, which is attached to a microprocessor controller. Description of the regulatory function and its control is described in Chapter 2.4

### 1.3.2 MIXING VALVE

#### Protection against corrosion of the boiler

The boiler is supplied to the consumer of basic equipment and regulatory controls. We recommend the extension of regulation of the boiler for additional regulatory elements, which contribute to convenient and economical operations. Each pump in system shall be controlled by a separate thermostat to avoid boiler hypothermia on return water inlet below 65 C. Connect the other elements should be proposed by the designer to the specific conditions of heating system. The electrical installation associated with additional boiler equipmnet must be carried out under the applicable professional standards.



To avoid hypothermia boiler, it is recommended installation of a separate thermoregulatory mixing valve. This solution enables the creation of a separate boiler and heating circuit. At temperatures above 65 °C thermostatic valve open circuit heating system. At a temperature below 65 °C is the heating circuit closed and the boiler works in a short circuit. This will prevent boiler hypothermia below 65 °C, reducing condensation of water vapor, acids and tars in the boiler. The temperature in the boiler it is recommended to keep the range 80-85 °C.

**Using mixing valves** are significantly increasing the life of the boiler. Function of the mixing valve lies in the fact that even at a higher temperature of water in the boiler body, temperature of water in the heating system can be controled and when appropriate, can be substantially lower. Control of water in the heating system may be manual or automatic with a servomotor on the mixing valve. Setting the flaps of thermoregulatory mixing valve can regulate the temperature of heating water regardless of water temperature in the boiler. Connecting the mixing valve to the heating system may involve the assembly organization and the elements you can buy directly as special accessories boiler retailers.

Greater comfort in operating boilers MODRATHERM ZEUS PYRO, as well as longer life is achieved by installing the appropriate mixing valves, respectively. accumulation or buffer tanks.

Recommended diagrams are listed in this guide in Chapter 10

### 1.3.3 EXHAUST FAN, SECURITY EXCHANGER AGAINST OVERHEATING

- **Exhaust flue gas fan** ensures reliable evacuation of the gases to the chimney and constant ratio of combustion air, which is needed for ecological burning with high efficiency. In operating the boiler at lower temperatures may cause condensation of moisture from flue gases.



- **Safety valve** with a fixed value of the maximum temperature of heating water (95 °C) protects against boiler overheating. Installing the outlet fitting G 1 / 2 "from the security exchanger.



#### Warning!

Cold water inlet to the exchanger must be safety during operation of the boiler always open. Pipe connecting on the inlet to the security exchanger must be provided with a pressure safety valve with the return flap (6 bar).

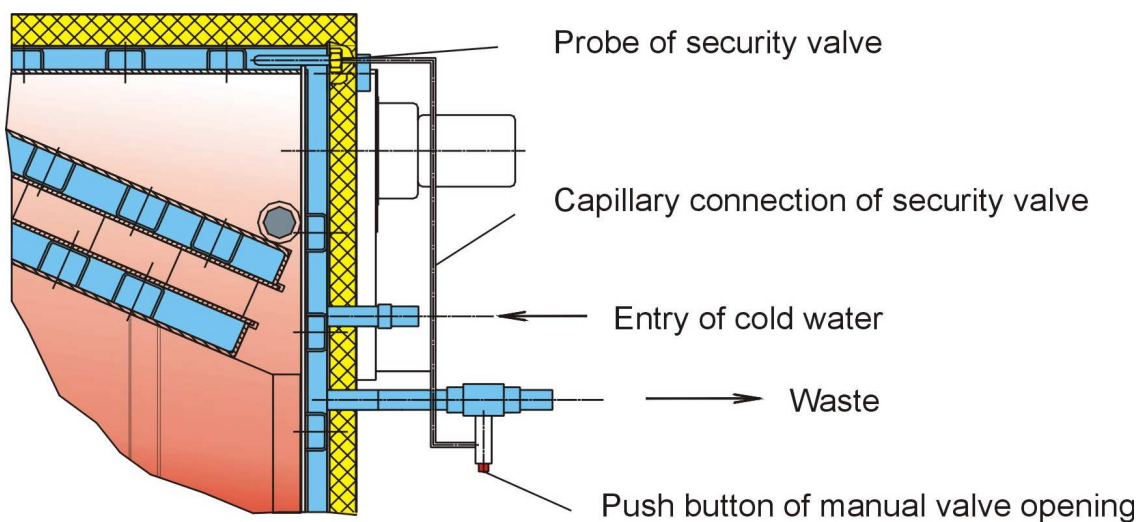

#### Specified parameters for cooling water:

Temperature	cca 15°C
Flow	9 l / min.
Max. pressure	6 bar
Min. pressure	2 bar

- Open for the primary air inlet into the primary air flap is located under the perforated front panel between the firing and ash door. The function of the flap and cleanness of the chamber behind the flap must be checked periodically and cleaned if necessary.

Securing the heating system with suitable device (eg, four-mixing valve) ensures the boiler against low corrosion, ie its operation so that the return water temperature falls not below 65 ° C. At the same time preventing undue pollution of the combustion chamber and flue ways.



### 1.3.4 SETTING OF PRIMARY AND SECONDARY AIR SUPPLY

#### Setting up and managing the flow of air into the combustion chamber.

The boiler is equipped with the following several regulatory elements, allowing for optimal adjustment of the boiler operation:

1. Exhaust fan - possibility to set the speed of rotation from 1 till 10, see 4.2.2.g.
2. Main flap for primary air supply, see. Legend on page 3.
3. Flap for primary air supply bottom, see. Legend on page 3.
4. Flap for secondary air supply, see legend on page 3.

These elements are set by the manufacturer and fixed for the output and the type of boiler, therefore, not recommended unnecessarily change their value settings. In case of change of settings for any of these elements may lead to a change in the quality of the combustion process. In the lower chimney draft can increase the set value by 1 unit and in a higher chimney draft can reduce the set value by 1 unit.

#### Values are as follows:

Boiler ZEUS PYRO	15	20	26	30	36	42
Exhaust fan			5	7	9	10
Main flap for primary air supply	on sale		2	3	5	6
Flap for primary air supply bottom	from X.2010		0	1	4	5
Flap for secondary air supply			2	3	8	9

In manual mode of run the fan, see. Rule 4.2.2.c, the fan always runs at set speed.

The first change the settings of the main sliding flap is only possible to control unscrewing the screw, removing the front panel by pulling together and release the two fixing screws of sliding flaps.

Changing the lower primary air flap is possible after opening lower door and release the two screws at the bottom of the upper horizontal door frame. Return to the original flap settings is performed in reverse order. Implement change settings of sliding flap for secondary air supply is not recommended when the boiler is in operation. In the flap above the value set indicates the size of the opening flap in cm. Wing screws that flap must be screwed always along the door frame to cover, that they do not make a block for metal cover and the door itself.

Change the secondary air flap is possible after the release of the right regulatory screws / when viewed from the rear boiler/.

The boiler is also equipped with a firing flap, which is controlled by turning the center nut with a plastic head of the upper door by unbolting about 2 cm, when the flap opens and reduce the risk of smoking into the room.. The center nut with a plastic head not to engage too much pressure by screwing to avoid embossing on the door frame. Flap is closed while it is still seen about 10 to 15 mm screw joint.

**During operation of the boiler the firing flap must be closed at all times(with the exception of firing or loadin fuel)!**



## 2. TECHNICAL DATA

### 2.1 MAIN DIMENSIONS

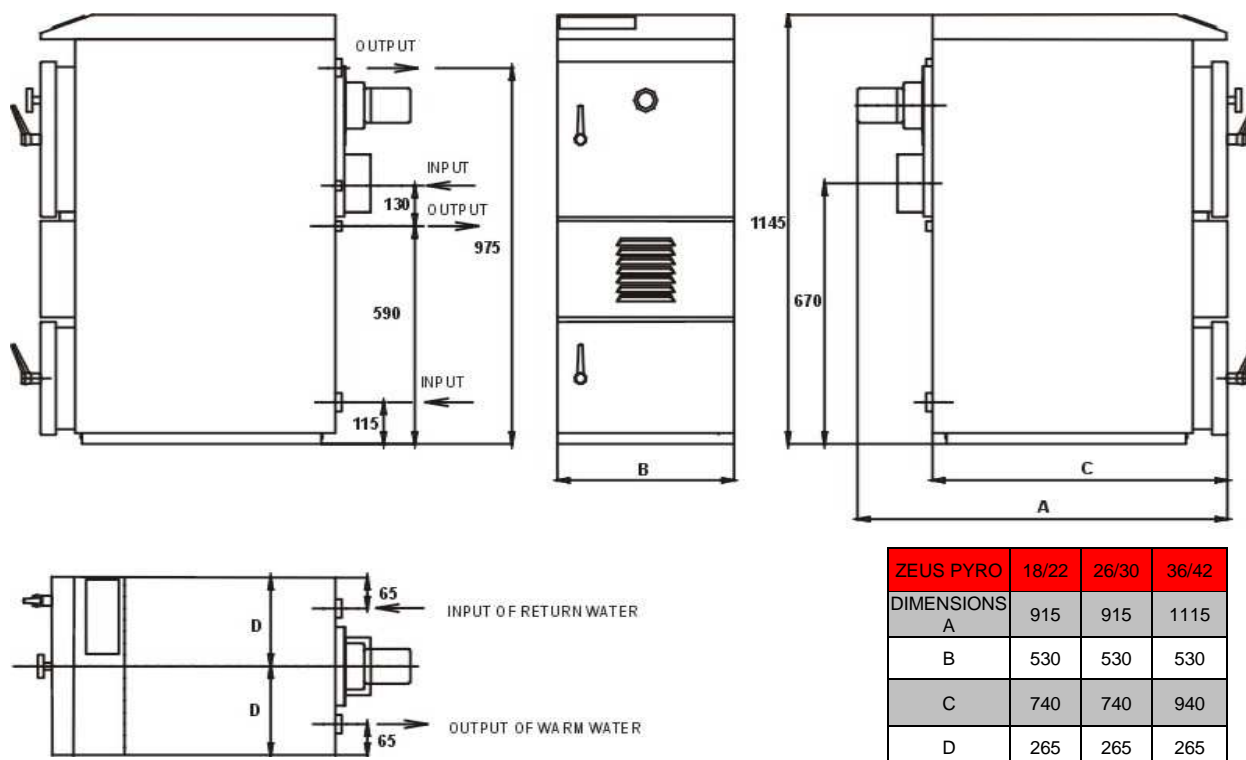

### 2.2 TECHNICAL DATA TABLE

MODRATHERM ZEUS PYRO							
TYP		ZEUS PYRO 15	ZEUS PYRO 20	ZEUS PYRO 26	ZEUS PYRO 30	ZEUS PYRO 36	ZEUS PYRO 42
Output range	(kW)	14,9	20	26	30	36	42
Boiler rank (STN EN 303-5)	-	3*	3*	3*	3*	3*	3*
Recommended fuel(STN EN 303-5)		rounded wood soft A1, rounded wood hart A2 splitted wood B1, B2 max.moisture 20%					
Fuel consumption for a season	(surround meter)	15	20	25	30	36	40
Efficiency	(%)	84 - 90					
Chimney draft	(mbar)	0,1 - 0,15		0,15 - 0,2		0,2 - 0,25	
Water volume	(l)	56		68		83	
Average flue gases temperature	(°C)	196	196	175	175	185	185
Boiler pressure lost at $\Delta T = 20/10K$	(mbar)	0,44/1,19		0,6 / 2,36		1,5 / 5,31	
Burning time at common running	(h)	4-8		5-10			
Maximálna hmotnosť paliva v spaľ. priestore	(kg)	24		33		40	
Min. temperature of return water	(°C)	65					
Max. working pressure	(bar)	2,5					
Max. working pressure of security exchanger	(bar)	6					
Combustion chambervolume	(dm <sup>3</sup> )	22		31			
Volume for wood	(dm <sup>3</sup> )	74		99		140	
Boilers dimensions (w x h x d)	(mm)	430 x 1145 x 915		530 x 1145 x 915		530 x 1145 x 1115	
Overall weight	(kg)	282	285	318	322	372	376
Ashtray dimensions (š x v x h)	(mm)	260 x 50 x 480		360 x 50 x 480		360 x 50 x 480	
Dimensions of loading hole(w x h)	(mm)	290 x 360	290 x 360	390 x 360	390 x 360	390 x 360	390 x 360
Chimney connecting	(mm)	152					
Power supply / frequency	V/Hz	230/50	230/50	230/50	230/50	230/50	230/50
Elektricity input power	W	50					
Elektricity cover	IP	40					

## 2.3 SUPPLIED AND REQUIRED ACCESSORIES

### Supplied accessories :

- Exhaust fan ATAS FCJ 4 C 52 S (*electromotor, propeller UCJ 4 C, capacitor 1 μF*)
- Cleaning tools
- 2pc of cable for connecting of the pumps
- filling valve 1/2“

### Obligatory accessories for placing the boiler into operation:

- safety valve HONEYWELL TS 130 respectively. safety valve STS 20 WATTS

## 3. BOILERS INSTALLATIONS

Installation of a boiler, installation of water and connected to the chimney can be made only by workers with professional qualifications for the job. Putting the boiler into operation, warranty and customer service can be performed only by **trained service organization** in heating installations and boilers.

Well professionally prepared project of heating system is the most important precondition for the satisfaction of users with products MODRATHERM of company MTH Ltd.

### 3.1 RELATED LEGISLATION

STN EN 303 – 5: 2001	Heating boilers for solid fuels hand and automatically delivered, with a rated power of 300 kW. Terminology, general requirements, testing, marking
(STN) ČSN 060830	Thermal systems in buildings
STN 06 1008:1997	Fire safety of heating equipment
STN 07 0245: 1993	Hot water and low pressure steam boilers. Technical requirements. Examination
STN 07 7401	Water and steam for thermal power equipment with working pressures of steam in 8Mpa
ČSN EN 13 501-1	Fire classification of construction products and building structures
ČSN 33 2000-3:1995	Electrical regulations
ČSN EN 50165-1	Electrical equipment for boilers and auxiliary equipment
ČSN EN 55014-1	Electromagnetic compatibility
ČSN EN 55014-2	Electromagnetic compatibility
ČSN EN 60335-1: 2003	Safety of electrical household appliances
ČSN EN 60335-2-102: 2007	Electrical appliances for household and similar purposes. Security
STN 73 0831	Fire safety engineering. Assembly areas.
STN 73 0822: 1987	Fire performance materials. The degree of combustibility of building materials
(STN) ČSN 734201	Designing chimneys and flues
Ministry of Interior Decree Nr. 401 / 2007 Coll establishing specifications and requirements for fire safety installation and operation of the fuel unit, an electrothermal appliance and central heating equipment and the construction and use of the chimney and flue, cleaning them and the time limits and checks.	
Regulation No. 308/2004 Coll laying down the details of technical requirements and conformity assessment procedures for electrical equipment used within certain voltage limits.	

By the installation, operation and servicing of boilers MODRATHERM ZEUS PYRO must be taken into account the related general application design, health and safety legislation.

### 3.2 BOILER PLACING

- According the CSN 33-2000-3:1995 may be a boiler installed in a basic environment 5/AB AA 5
- Location of boilers in residential space, including corridors is prohibited!
- Boiler must be installed so, that before it is a free space for a layout about 1 x 1 m
- Boiler is installed to a non-combustible, heat-isolating pad footprint in excess of the boiler around the entire circumference of 100 mm.

- Boiler is recommended to place on a concrete base of at least 50 mm high, see the fifth chapter
- According to the ČSN EN 13501-1 the smallest permissible distance of external dimensions of the boiler and chimney from flammable materials must be at least 400 mm.

### 3.3 CONNECTING TO HEATING SYSTEM

- The boiler is connected to the heating system with threaded connection G 6 / 4. Threaded joints of safety exchanger shall have G 1 / 2 ".
- The heating system may fuses and releases through the ball 1 / 2 "valve at the bottom rear of the boiler. By filling the heating system must be open venting valves on radiators and the system is filled slowly so , that the air can escape in the places of venting. After filling the system the venting valves must be closed.
- When you first put into service, the heating system must be degassed. Degassing is performed by heating the heating water to the maximum operating temperature, ie at 90 °C for 4 hours. After degassing, the system must be again filled up with water to the recommended pressure.
- **Heating water quality must comply with conditions in accordance with STN 07 7401**
- **In the event that the boiler is installed in a closed heating system, the heating system must be equipped with pressure safety valve.**
- **Heating system must be equipped with a pressure gauge.**
- **Boiler shall be equipped with safety valve Honeywell TS130 or STS 20 WATTS against overheating**

### 3.4 CONNECTING TO THE CHIMNEY

- Connecting flue must be in accordance with relevant standards. Connecting the boiler to the chimney must be transferred with the consent of the chimney company. Boiler flue outlet diameter is 150 mm. The diameter of the chimney must not be smaller than the outlet from the boiler. Flue is mounted directly into the flue hole. When not possible, the adapter can be installed, but it should not be longer than 1 m.
- Recommended chimney draft for the correct operation of the boiler is min. 0.15 to 0.25 mbar. Too much chimney draft, reduces boiler efficiency and distort its combustion. In this case it is necessary to install throttle between boiler flue and chimney. Proper chimney draft is a requirement for proper combustion, performance and durability of the boiler.
- Chimney, which is connected to the boiler may no longer be used to connect the other unit.
- When installing the flue, must be taken into account the requirements of following standards and regulations:

STN 73 4201: 2008	Designing chimneys and flues
Ministry of Interior Decree Nr. 401 / 2007 Coll establishing specifications and requirements for fire safety during installation and operation of the fuel appliances electrothermal appliances and central heating equipment and the construction and use of chimneys and flues, and limits their cleaning and checks.	

Information values of the chimney diameter :

20 x 20 cm	minimal high 6m
Ø 20 cm	minimal high 7m
15 x 15 cm	minimal high 10m
Ø 16 cm	minimal high 11m

These values have only information purposes. The exact size of the chimney should be set according to the standards

#### WARNING!

**Given the natural condensation of water vapor from the flue gas must be chimneys, chimney liners, vents and condensate collecting container made of durable materials. Chimneys must be fitted with a slight upward gradient (according to CSN 73 4201 Art. 7.1.1 with a slope of 3 ° respectively. 5%), the shortest route to the chimney. Boiler flue connecting to chimney must be removable for servicing operations.**

### 3.5 ELECTRICAL WIRING SCHEME

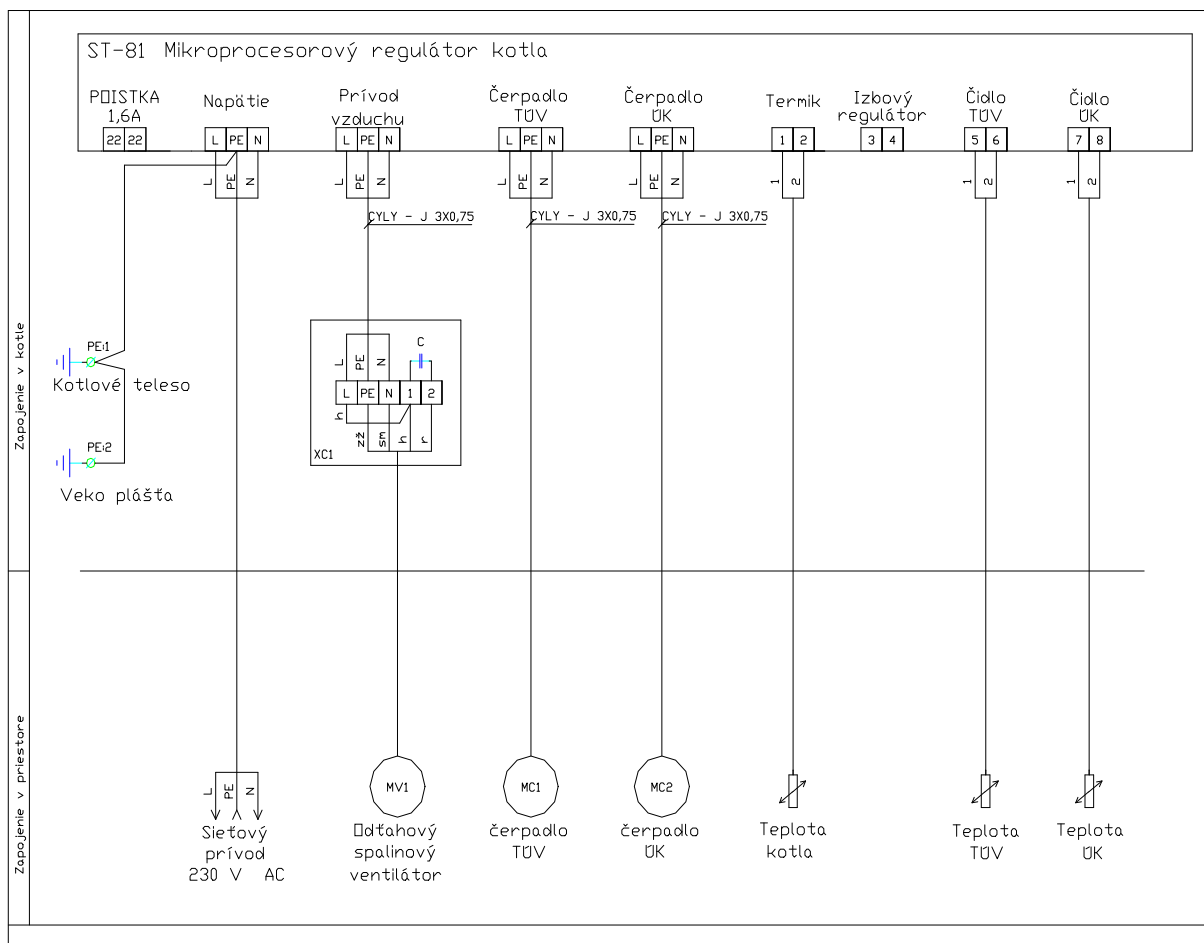

**Legend:**

**4.**

**L** phase conductor – brown  
**PE** earth conductor – yellow-green  
**N** neutral conductor - blue  
**C** fan capacitor  
**FUSE** fuse F 1,6 A

**h** brown wire  
**žž** yellow-green wire  
**sm** light blue wire  
**h** brown wire  
**r** red wire

## OPERATION and boiler operation

### 4.1 PUTTING THE BOILER INTO OPERATION

**This appliance is not intended for use by persons (including children) with reduced physical, sensory or mental incapacity or lack of experience and knowledge prevents the safe use of the unit, while they are not under control or not be instructed with the appliance usage with the person responsible for their safety.**

Installation of the boiler, installation of security features and installation of the chimney can be made only by workers with professional qualifications for the job. Threats to power of the boiler and removal of insulation sheets can be performed only by trained service technicians in the heating equipment.

#### **Warning!**

**First put into operation and setting of the boiler can be performed only by trained service technician in the heating equipment.**

When putting into operation of the boiler service technician will make a record of putting the boiler into operation, see page 29. Putting into operation of the boiler service technician is a prerequisite for recognition of the 24-month warranty on the boiler.

**Procedure for placing the boiler into operation:  
(applies to the service technician)**

■ **control activities prior to putting into operation**

- a) fill the heating system, control of water pressure, tightness of joints, venting
- b) control connecting to the chimney (make, leak, chimney draft)

■ **putting the boiler into operation**

- a) open valves of the heating system,
- b) open valves of the safety exchanger,
- c) Press the red button of safety valve several times for venting the safety exchanger and check its function. After you release the valve button, the valve should not leak,
- d) open firing flap through the central matrix with a plastic head in the upper door by screwing out about 2 cm. For faster firing the lower door can be opened.
- e) the main power switch on the boiler, with the buttons set the temperature to about 85 °C, start flue gas fan, light the material (ie, small dry wood chips, under which it can be a bit of newspaper) through the lower grille door. For firing can also be used fire material for wood heating. After sufficient firing / no burning out / attach several cutten thin logs of wood in the heating area so as to gradually create enough about 10-15 cm high layer of molten fuel. During this preparatory phase the fan must be operating. In case of proper installation of central heating / see. eg. Chapter 12 Recommended diagrams / during this preparatory phase of operation of the boiler should be until the boiler water temperature reaches 65 °C / see chapter 1.3.2 / heating circuit closed.
- f) After reaching the above condition, add another wood according to the needs, close the firing flap and lower door. Loading space add with fuel to full after the boiler water temperature reaches 85 °C. The process according to the size of the volume of space heating and water quantity in the heating system can take 60-120 min. During this time, gradually the entire heating system heats up to optimum operating condition in order of first heat and accumulation of heat in the boiler and refractory concrete chamber to the temperature of gasification and pyrolysis of fuel and the subsequent gradual automatic / built-in servomotor for mixing valve / opening of the heating circuit to reach the set temperature in the room. / Heated house /.
- g) Following the above procedure and the achievement of that state, the boiler will be optimum operated with high efficiency, clean and efficient combustion. Keeping the boiler and heating system throughout the state will provide you significant fuel savings and durability of the boiler. To achieve optimum operating performance is very appropriate involvement of the buffer tanks /storage reservoir/ to the heating system / see. Chapter 12 /, thus increasing the comfort and heating.
- h) When checking the operation of the boiler, it is necessary to proceed as follows (**the user pays for the boiler**):
  - ✓ Check the operation of the combustion fan. If the fan is on, its operation should be smooth and silent
  - ✓ Check the boiler room stokers and, where appropriate, make rake out of grates and wood,

**Before opening the door to proceed as follows:**

  - ✓ flue gas fan when not in use, turn on the flue gas fan
  - ✓ with the screw in the middle of the firing door open firing flap,
  - ✓ in that state to wait about 30 seconds to an accumulation of wood gas from the chamber vent,
  - ✓ upper door open slowly.
  - ✓ If the wood in the stokers is not evenly distributed, they must be rake and, if necessary accompanied by a full dose,

**After you close the firing door:**

  - ✓ closed firing flap with screw (tighten with a light touch to stop)
  - ✓ if the fan is running manually, **turn off the fan! (See chapter 4.2)**

**For each wood loading check the cleanness and passage of the combustion chamber nozzle, which air flows into the combustion chamber. Clogged nozzles resulting in deterioration of performance and quality of combustion.**

- **serviceman when placing boiler in operation is required to adequately inform the user of the boiler operation**
- **make a notice into the owner's manual**

## 4.2 OPERATION OF THE CONTROL REGULATOR



**WARNING!**

### **ELECTRICAL EQUIPMENT live!**

Before performing any activities related to power supply (connection cables, installation equipment, etc.) , first make sure the regulator is not connected to the electricity grid! If the regulator is connected to the electricity grid, the regulator should be disconnected from the mains.  
Installation can be performed only with the licensed electrician.

### 4.2.1 DESCRIPTION

Electronic temperature regulator ST-81 is designed to operate all functions of the boiler, which are as follows:

- Boiler water temperature and hot water tank temperature setting
- Hysteresis settings of boiler water temperature and hot water tank temperature
- Temperature setting of switch on the pump for central heating and hot water heating
- Weekly programming of the heating system
- Automatic switch off the ventilator in case there is no wood
- Fan speed adjustable in 10 levels
- Automatic ventilation chamber in case the exhaust fan is not running (adjustable time intervals and the time of fan operation)
- Summer time (only heating hot water tank)
- Priority of heating hot water storage function
- Function of constant running pump of central heating
- Connection of room controller
- Manually run the exhaust fan, pump central heating and hot water boiler
- Protection against overheating
- Function Thermodynamics - additional protection against boiler overheating
- Sound the alarm signal in case the probes are damaged
- Signaling of running the central heating and hot water pumps, combustion fan and manual start of combustion fan by LEDs

**The importance of control buttons and lights:**

EXIT	Exit from the menu
MINUS	Increase of the values, movement in the menu
PLUS	Decreasing of the values, movement in the menu
MENU	Entry to the menu, settings confirmation
Manual operation check light	Lights when manual fan running
Fan check light	Lights when the fan is in operation
Central heating pump check light	Lights when the central heating pump is in operation
Warm water pump check light	Lights when warm water pump is in operation

- If the boiler temperature is lower than **the selected temperature** controller is automatically set to the operating system with continuous air supply until the boiler water temperature reaches the desired temperature.
- If the boiler is equal to or greater than **the chosen temperature**, the controller switches to standby.

Set each regulator should be made individually, taking into account the needs and requirements for heating. MTH Company Ltd. is not responsible for incorrect setting of the regulator and the associated incorrect operation of the boiler and consequences.

**4.2.2 FUNCTION OF THE REGULATOR**



This chapter describes regulator functions, how to change settings and view the menu.

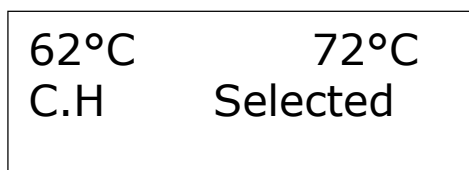

**a) Initial panel**



In normal operation, the controller on the LCD displays panel base on which appear the following information:

- **Contemporary boilers temperature (C.H.)**
- **Contemporary setted temperature ( Selected )**

Buttons  and  on this toolbar allow us to quickly change the **selected temperature**. Press the **MENU** button, the user moves to the first menu level. The display will show the first two lines of menu. In any

menu, you can move through the keys  and . Press the **MENU** button refers to a submenu or more runs the current selection. Press the **EXIT** button, the user gets back to the menu. In the case of the base panel display when you press and hold the **EXIT**, displays panel with the notice of the pump is switched on or off, respectively. information on the actual temperature of hot water storage tank and hot water selected temperature.

**b) Begin of firing in theboiler**



Function stored in this menu is used to manually start the vetilator by starting of the firing in the boiler or by fuel adding while boiler water temperature drops below 50 ° C. Press **the MENU** button to start the fan

while the indicator of manual mode lights. On reaching the boiler water temperature 50 ° C turns off the light of manual mode, the fan switches to automatic mode and name **Ignition** changes to **On / Off. Valve** .. The fan will turn off automatically after a set temperature of boiler water is reached.

In case that by a boiler water temperature above 50°C comes to manual switch off the fan by using the Funktion **On / Off Fan**, is shown on the display symbol, \*‘‘.

c) Manual control

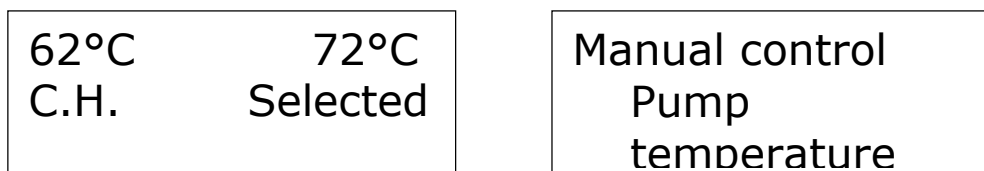

To increase user comfort, the controller module is equipped with a **manual control**. In this capacity, each element of the system on and off independently from the others.

Press the **MENU**, switch on / off the fan.

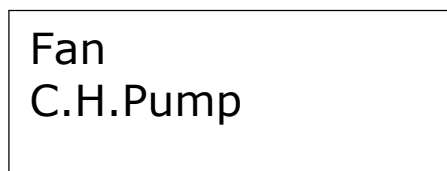

Press the **MENU**, switch on / off pump water heating

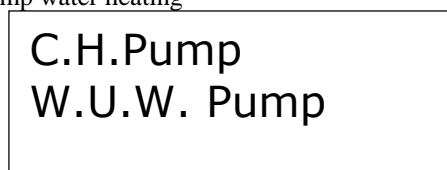

Press the **MENU**, switch on / off hot water pump (tank).

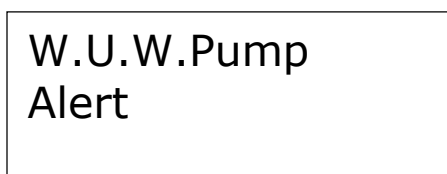

Press **MENU** to enable / disable alarm (see also Chapter Alarm).

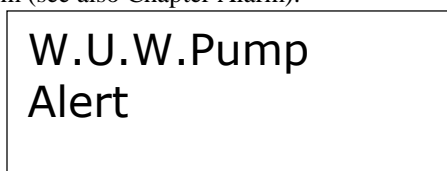



## d) Settings of temperature of pumps activation

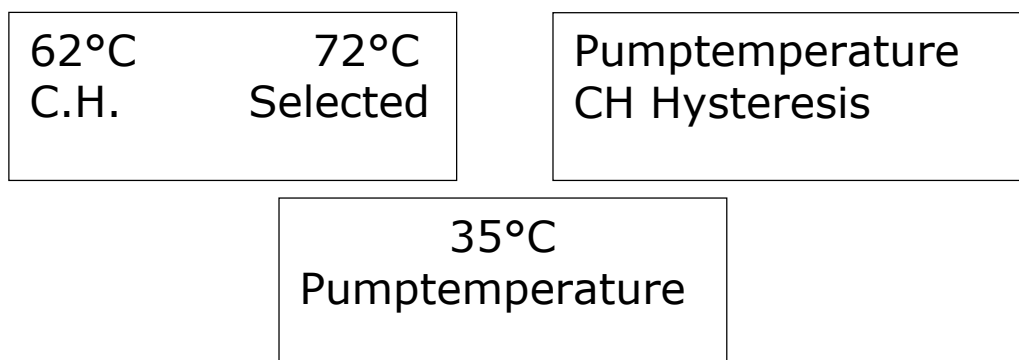

This option is for setting the temperature at which the pump of heating water and hot water (temperature measured in the storage tank) turns on. Pumps do not work until the temperature is reached, when it exceeds the selected temperature both pumps switches on, but work according to their settings. (see the function of **activating the pump hot water - a priority for the boiler or pump function of continuous operation CH**).

## e) Hysteresis of central heating (boiler)

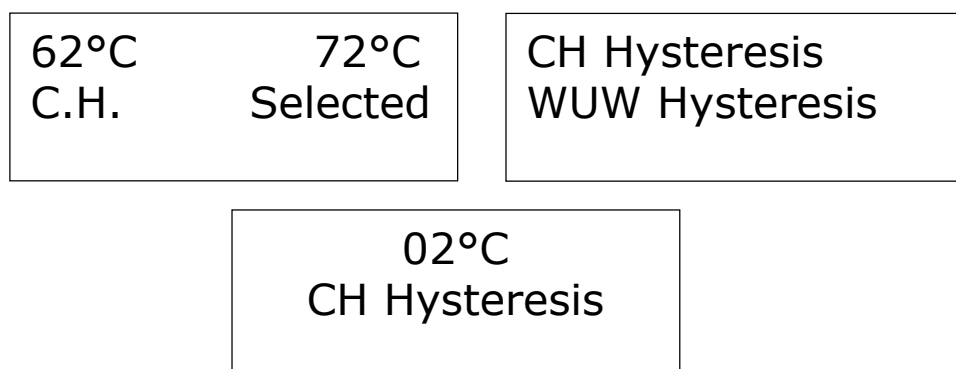

This option is selected for adjusting the temperature hysteresis. The difference between the temperature of transition into sleep mode and re-transition temperature of the operating system (eg if the selected temperature reaches 60 ° C and hysteresis of 3 ° C, the transition into sleep mode will follow the temperature reaches 60 ° C, instead switch back to operating mode will follow the temperature drops to 57 ° C).

## f) Hysteresis of warm water

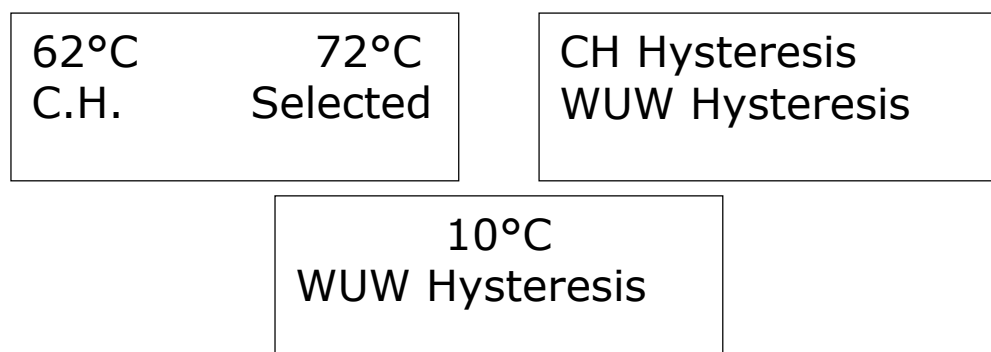

This option is for adjusting the temperature hysteresis for the selected storage tank. The difference between the temperature (in the required storage tank) and the actual temperature in the storage tank (eg if the selected temperature reaches 55 ° C and a hysteresis of 5 ° C, hot water pump will switch off when the chosen temperature reached 55 ° C, which starts pump of water heating and re-start of hot water pump will follow after falling the temperature to 50 ° C).

## g) Fan speed

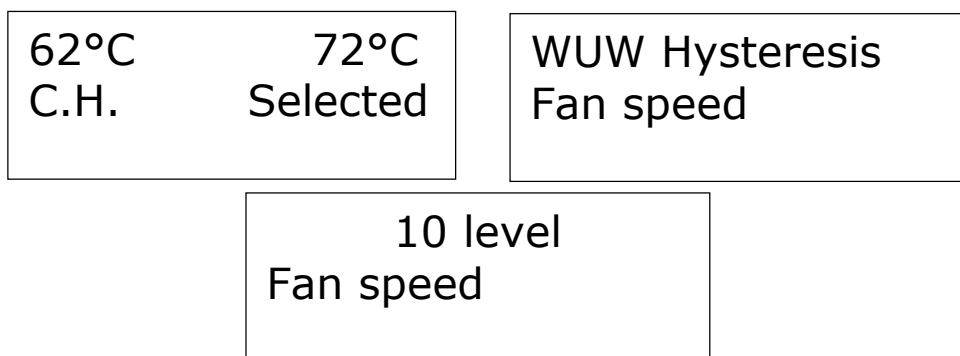

This feature controls fan speed. The adjustable range is between 1 to 10 (can be seen as gears fan). The higher the level, the faster the fan is working, with 1 degree is the minimum fan speed and with 10 degree is maximum power.

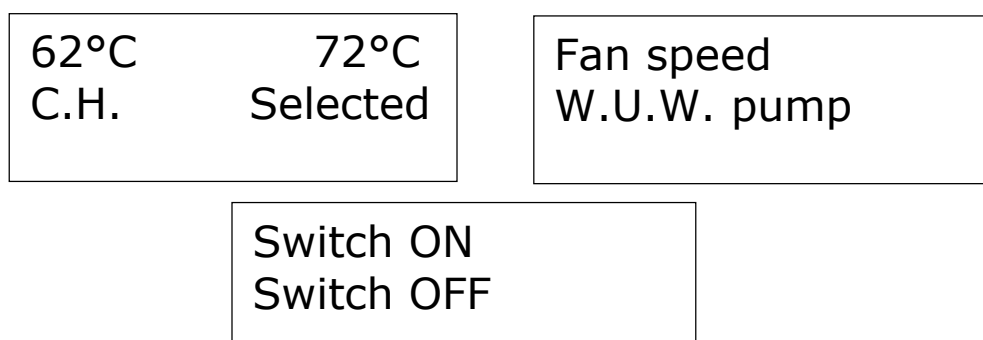

The scope of the fan speed is changed by , and  buttons. The fan is always switched on at full speed, enabling it to be switch on even when the engine slightly dusty.

## h) Activation of hot water pump - boiler priority



Activating the pump of hot water , the controller switches to a priority system storage tank. In this mode, hot water tank pump remains switched on until it reaches the set temperature. After reaching the temperature the pump switch off and activates the central heating pump.

Posted hot water pump temperature we change by pressing **EXIT** (hold for a few seconds). The display shows the selected temperature of the hot water tank and the actual temperature of the hot water tank The range

of setted temperature we change by  and  buttons. After a few seconds the display returns to its original state. After the entered temperature of hot water tank will reach, the pump hot water turns off and central heating pump is switched on.

In this mode, operation of the fan is limited to 75 ° C in the boiler, which prevent its overheating. The boiler in this state persists until it reaches the **desired temperature** in the storage tank. When the temperature reaches the hot water pump switch off and the central heating pump switch on. Central heating pump is in operation at all times to the point where the temperature in the storage tank reaches the desired set by hysteresis, which shuts down the pump for central heating and switching on hot water pump. By the priority function of hot water is first heated hot water and then water in the radiator.

**NOTE:** The boiler must be in the circulation system with pumps equipped with back flaps. Flap mounted on the pump hot water prior to extrusion of the hot water from boiler. Flap mounted on a central heating circulator impervious to hot water boiler that heats the house.

## i) Indoor regulator

62°C C.H.	72°C Selected	W.U.W. pump Indoor regulator
Switch ON Switch OFF		62°C C.H.
		72°C p Selected

The regulator ST-81 can work with room thermostat, which in this case has a higher priority, except in the heating boiler with warm water. Fan and by some types of control members also the central heating pump work until achieving chosen temperature on the room controller. When you turn on the room thermostat option, display the letter "p".

**Connecting room thermostat:** From the room thermostat leads two wire cable to connect the mounting member of the controller specified as room thermostat.

**NOTE:** The exit room thermostat must be connected any external voltage.

## j) Summer mode

62°C C.H.	72°C Selected	Indoor regulator Summer mode
Switch ON Switch OFF		23°C CH
		23°C 50°C WUW Set

When activated, this function shuts down the pump of central heating and hot water pump is switched on when crossing the set temperature (see the switching function of temperature pumps) and hot water pump is working continuously. In the summer mode is adjusted only temperature on the boiler, which heats the warm water in the storage tank. When you turn on the summer mode on the display light the letter "I".

## k) Ventilation time and ventilation break of the combustion chamber.

62°C C.H.	72°C Selected	Ventilation time Ventilation break
5 second Ventilation time		5 minute Ventilation break

Function stored in this menu is used to regulate the boiler during operation in the standby mode. Prevents boiler to burn out if the temperature is maintained at a selected temperature over 50 C..

In this function, is adjusted ventilation time of the fan and ventilation break of the fan. The ventilation break time is set in minutes in the menu **VENTILATION BREAK** . When the time is elapsed, will the fan switch on on the time set in the controller. The fan runnin time is set in seconds in the **VENTILATIO TIME** menu. Ventilation break time and ventilation time is good to set according to the conditionios of heating system.

**CAUTION: Incorrect setting of the options may result in permanent increases in temperature! Ventilation time of peace may not be too short.**

#### l) Constant running of central heatinh pump

62°C C.H.	72°C Selected	Ventilationbreak Constant CH Pump
Switch ON Switch OFF	62°C C.H.	72°C c Selected

In this mode, the pump begins operation simultaneously after reaching the set temperature (see temperature switching function pumps). The pump of central heating operates continuously and central heating hot water pump turns off after reaching temperature entered the boiler. After you turn on the pump central heating constant running to display the letter "c".

**Note:** This mode is calculated using a three-way valve or other mixing valve to maintain different temperatures in the boiler and another in the house.

#### m) Language

62°C C.H.	72°C Selected	Language Week schedule
--------------	------------------	---------------------------

Function stored in the settings menu is used to control the language.

In the menu are standard stored the following menu languages :

- Slovak, Czech, Russian, German, Hungarian, Slovenian, Romanian

#### n) Week schedule

62°C C.H.	72°C Selected	Week schedule Base set-up
Time Date		

Features programming designed for daily temperature changes. The controller can be configured in two modes:

- the first mode of temperature variation is adjusted for each day separately;
- second mode allows setting the temperature change for weekdays (Monday - Friday) and weekends (Saturday - Sunday).

After activating the function of the base panel displays the letter "t" (the number provides information on active mode), which informs on the activities of the week.

### Time setting :

#### Monday

**Beginning** indicates from which hour the temperature should start to rise or fall.

**Finishing** indicates till which hour the temperature should rise or fall.

**Temperature change**, how many degrees of temperature increase or decrease, for example.:

Monday  
 Begin 6<sup>00</sup>  
 End 14<sup>00</sup>  
 Temperature difference – 10 °C

In this case, this means that if selected to the boiler temperature is 50 ° C, 6.00 hours from Monday until 14.00 hours the temperature chosen for the boiler falls to 10 ° C to current 40 ° C.

#### o) Base set-up

<div style="display: flex; justify-content: space-around;"> <div style="text-align: center;">62°C C.H.</div> <div style="text-align: center;">72°C Selected</div> </div>	<div style="text-align: center;">Week schedule Base set-up</div>
<div style="border: 1px solid black; width: 100%; height: 50px; display: flex; align-items: center; justify-content: center;"> <span style="font-size: 24px; margin-right: 20px;">No</span> <span>Yes</span> </div>	

The controller is pre-configured and ready for operation. However, it can be adapted to their own needs. You can always return to corporate settings. Turning elections corporate settings but you lose all your custom settings of the boiler, which will be replaced by the original manufacturer's preferences. From now on you can set your own parameters of the boiler again.

### 4.2.3 PROTECTION

To ensure the safest and trouble-free operation of the regulator is equipped with a wide range of security features. In the event of a failure triggered an alert sounds, and display relevant information. Press the MENU button to return controller to the operation.

#### a) Thermal protection

It provides additional bimetallic minisensor (sensor located in the boiler), which by overrun the boiler water temperature will switch off the fan. Temperature range to start the alarm ranges from 95 ° C and 100 ° C. Prevents yeast water in the installation in the event of overheating or damage to the boiler controller. By thermal protection of this type is a return to the starting position secured automatically.

### b) Automatic probe controll

In case of damage sensor central heating and hot water temperature starts to alarm and display an error message:

W.U.W. Temp probe  
damaged

### c) Protection against yeast water in the boiler

This protection precedes the increase of high temperature in the boiler (**only in the priority functions boiler**), where it is specified as the boiler temperature to 55 ° C and the boiler temperature recorded 75 ° C, the control member switch off the fan. If the temperature rises to 85 ° C, central heating pump is switched on. If the temperature continues to rise, turn on the alarm (at 95 ° C). The same situation may arise in the event of damage to the boiler, the sensor incorrectly fitted or damaged pump. However, if the temperature drops, the control member will switch on the fan by 70 ° C and will work until it reaches the specified temperature for the boiler.

### d) Heat protection

The regulator has for damage bimetallic sensor additional insurance: the temperature exceeded 95 ° C to turn on alarm signal to the display:

Alert  
High temperature

By thermal protection of this type is to return to the starting position need to manually unlock the thermostat, press



### e) Fuse

Network controller provides protection tube fuse-links WT 6.3 A

**WARNING:** Do not fuse with a higher value. The establishment of the fuses with a high value you can damage the operating member.

In the event of any failure of the mentioned protective function is the boiler equipped with safety equipment listed on page 6 in Chapter 1.3

## 4.2.4 REGULATOR MAINTANCE

Before the heating season and also during check technical condition of control cables of the member ST-81 Check also the mounting of the controller and clean it from dust and other impurities. Do measure the effectiveness of grounding motors (central heating pumps, hot water pumps, air supply).

#### 4.2.5 TECHNICAL PARAMETERS OF REGULATOR

Number	Description	Unit of measure	
1	Power output	V	230V/50Hz +/-10%
2	Input power	W	4
3	Ambient temperature	°C	10 ÷ 50
4	Output load feeding	A	2,5
5	output load circuit pump	A	1
6	Output load air inlet	A	1
7	temperature range of measurement	°C	0 ÷ 90
8	The accuracy of the measurement	°C	1
9	range of temperature settings	°C	45 ÷ 90
10	sensor heat resistance	°C	- 25 ÷ 100
11	insert fuse	A	1,6

#### 4.2.6 INSTALLATION

**NOTE:** Installation must be carried out by workers with professional qualifications for the job.! The appliance **must not be under tension** during assembly (make sure the plug is removed from the socket)!

**WARNING:** Incorrect cabling can harm the controller!

Controller must work in a closed system with no central heating features. Is required to ensure the installation of safety valves, pressure balancing valves and buffer tanks, which protect the boiler against overheating of boiler water in heating system, boiler clogging, higher fan strain etc.

#### 4.3 RANGE OF WORKS FOR THE ANNUAL INSPECTION AND MAINTENANCE

**Annual inspection and maintenance the contract service technician performs the following scale:**

- control flue road surface and internal parts of the boiler control
- functions control of all regulatory and security features
- check the safety valve
- check and clean the fan, fan chamber and the fan propeller (to ensure tightness of the chamber fan)
- control for tightness of loading and ash door
- control chimney draft

Annual inspection and maintenance is performed on call the customer and is paid for by customers.

#### 4.4 USER SERVICING OF BOILER

Putting into operation always perform as described in the previous section 4.1.

##### **Important information!**

1. Ash door must be after firing during the regular operation always closed
2. If necessary, empty the ashtray (use gloves)
3. The boiler can operate only adults (older than 18 years) who are demonstrably familiar with the operation of the boiler.  
For security reasons, we recommend to check the boiler by each loading or every eight hours
4. They are allowed no interference with the boiler, which could endanger the safe operation
5. When working with flammable materials in the room, where the boiler is operated, with sufficient time to shutdown the boiler from operation.
6. The ignition of the boiler is prohibited with flammable liquids. It is recommended to use only approved arsonist
7. Comply with fire regulations of general application
8. After the heating season should be thoroughly cleaned boiler (flue gas path, the walls of the boiler, etc.) and flues

9. By the occurrence of any problems with the operation of the boiler it is the contract service technician to call.
10. The customer is to provide a regular annual inspection of the boiler to the extent described in Section 4.2 through a contractual service technician before each heating season.
11. When you open the loading door and ash door use gloves with thermal - insulation properties.
12. In carrying out the loading area of the fuel used gloves with thermal - insulation properties
13. In carrying out the loading area to ensure clean air inlet
14. Mechanical cleaning of flue roa with scraper or brush
15. Clean vents between the grate.

**By the boiler operation should be taken into note following information:**

- Operating temperature of the water in the boiler to be in the range of 80-85 ° C
- Humidity of the fuel used shall not exceed 20%. The more fuel moisture decreases power of the boiler, increasing its consumption and forming of tar, which affects the life of each boiler. Degree of influence of moisture on the fuel consumption can be seen below:

Stored	Wood moisture	Wood caloric value	Wood consumption	Wood consumption	Costs for the wood	Price 1 GJ	Weight 1 prm
in month	(%)	(MJ/kg)	(kg)	(prm)	(EUR)	(EUR)	(kg)
14-20	10	16,4	10726	16,50	495	2,8	598
10-14	20	14,28	12318	18,95	569	3,2	650
6-10	30	12,18	14442	22,22	664	3,8	768
2-6	40	10,1	17416	26,79	800	4,6	930
Wood wet	50	8,1	21716	33,41	998	5,7	1177

- house warmth consumption by heat losst of 20 kW makes 175,9GJ/year
- 1 prm wood = 650 kg
- fuel : beech
- price for 1 prm = 30,-EUR

- By the storage of timber will rise its energy value
- For reduction of tar formation and condensation is to install a mixing device thermoregulatory valve to keep a minimum temperature of the boiler return water to 65 ° C.
- Boiler must be not permanently operated in the power range of less than 50%
- To achieve longer life of the boiler and fuel savings of 20-30% we recommend installation of a boiler with accumulation tanks and mixing equipment. If you can not install the boiler with buffer tanks, we recommend installing a boiler with at least one balancing tank, the volume should be about 25 liters to 1 kW power boiler.
- Ecological and economic operation of the boiler is at rated power.
- Choice of the correct size of the boiler, ie. its heating power is a very important condition for economic operation and proper functioning of the boiler. Size, respectively. performance of the boiler must be chosen so that the nominal power responds to the heat loss of heated object. Installation of the boiler with higher power may cause a higher building of tarr and increasing boiler condensation, resulting in a reduction of the lifetime and a deterioration of the ecology and economy of operation.

**Condition for guarantee recognition of the boiler:**

- Operation of the boiler with the prescribed fuel-wood, the humidity does not exceed 20%
- To install in the heating system a suitable mixing device to ensure the operation temperature of return water to the boiler at least 65 ° C.
- The installation of thermostatic safety valve on the security boiler heat exchanger (Honeywell TS 130) connected to a source of cooling water.
- To install the thermoregulatory valve in the system, which ensures the temperature of return water to the boiler at least 65 ° C
- Regular maintenance of boilers referred to in point 4.3 and 4.4
- Installing of reccomended buffer tanks with reccomended minimum volume



#### 4.5 REGULAR MAINTENANCE

**Periodically carry out the cleaning of the combustion chamber by combustion picks through the nozzle. Combustion chamber clean is prohibited during operation of the boiler. It can leads to dangerous accidents and fire. This cleaning is performed only when the boiler is out of service.**

Keep the ashes in incombustible containers with age. When handling, use protective equipment and take care of personal safety.

If there was an over-coating depositions in the flue tarred roads, it is necessary to mechanically remove the coating.

#### **WARNING!**

**Frequent and excessive tarr building of internal parts of the boiler shows incorrect operation with negative impact on the life of the boiler, the economy and ecology of combustion.**

**In the event of any failure condition of the boiler it is necessary to immediately interrupt the operation of the boiler (main switch off the boiler and under the constant surveillance to ensure the burn out of the fuel by opened firinf flap) and immediately call a service technician. It is forbidden to interfere with the non-professionalism to electrical parts of the boiler.**

**Regular and thorough cleaning is essential to ensure lasting performance and durability of the boiler. In case of insufficient cleaning may damage the boiler.**

#### 4.6 REMOVING OF THE COVER TOP

#### **WARNING!**

**Before removing the cover of the boiler, the boiler must be disconnected from the mains. His re-engagement is possible only after placing the lid of the boiler to the original location.**

Removing boiler casing lid is entitled to make a service technician for appropriate service action. Removing the cover is made, that by first in the right front part of the lid under the overhang of the lid is removed the cross-screw and with adequate pressure then lifts the lid, which is fixed by four spring pins to the boiler body. The lid of the cover is mounted to boiler body with grounding cable, so lift the lid to be done carefully. Reassembly is performed by reverse procedure. The reassembly must be done carefully to avoid any compression of the cables between thi bid and the boiler body

### 5. SAFETY AND FIRE MEASURES

When installing and operating the boiler, it is necessary to comply with all safety and fire regulations:

1. In the room where the boiler is located, shall be stored no combustibile material (wood, paper, oil and other flammable substances). The minimum allowable distance to the outer edge of the boiler and a chimney of combustibile material is 400 mm. This distance must be maintained even when the material where the degree of fire can not be demonstrated. (See more specifications ČSN EN 13 501:1)
2. The boiler and a distance smaller than the smallest distance allowed under paragraph 1 shall not be imposed or the room where the boiler is located, shall not be held articles of combustibile materials (wood, paper, paint, oil, rubber, gasoline, etc.)
3. In cases, where there might be intermediate risk of flammable gases or vapors or intermediate risk of fire or explosion (eg PVC gluing, painting work, etc..) must be the boiler before the occurrence of this hazard out of service.

The boiler must stand firmly on level ground. The space around the boiler must permit the installation, operation and eventual repair.

#### ■ **protective shield**

According to the Ministry of Interior **Nr.401/2007 Coll** the protective shiled must be made of material reaction to fire class A1 or A2, with a thickness of 3 mm.

#### ■ **insulation pad**

According to the Ministry of Interior **Nr.401/2007 Coll** the insulation pad must be made of material reaction to fire class A1 or A2, with a thickness of 1 mm, in normal operation resists the effects of mechanical loading. Temperature rise of the protected surface - the floor must not exceed 100 C.

■ **chimneys**

According to the Ministry of Interior **Nr.401/2007 Coll** chimneys must be installed at a safe distance from surrounding flammable structures of reaction class to fire B, C, D, E and F. Secure distance represents **800mm** (§ 13).

■ **example of placing the protective pad of a fuel appliance under the Ministry of Interior Decree Nr. 401 / 2007 Coll**

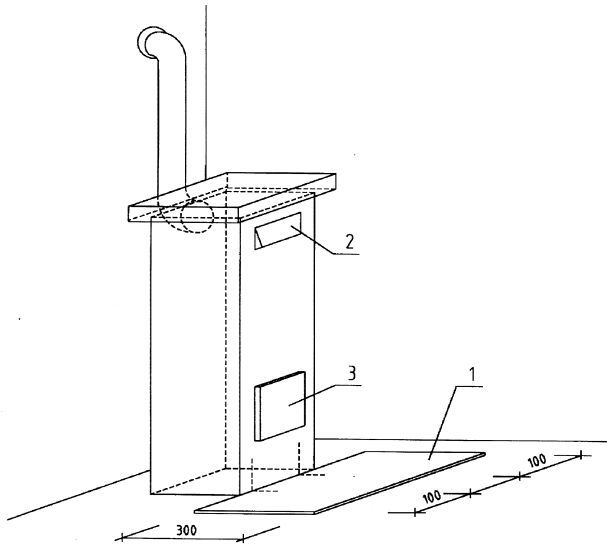

- 1 - protective pad of fuel appliance
- 2 - hole stokers
- 3 - ash hole

Protective pad should be made of non-combustible material at least 1 mm thick, in normal operation resistant to mechanical impact load.

■ **example of placing the protective shield of the appliance or flue in accordance with the Decree of the Ministry of Interior Nr. 401 / 2007 Coll**

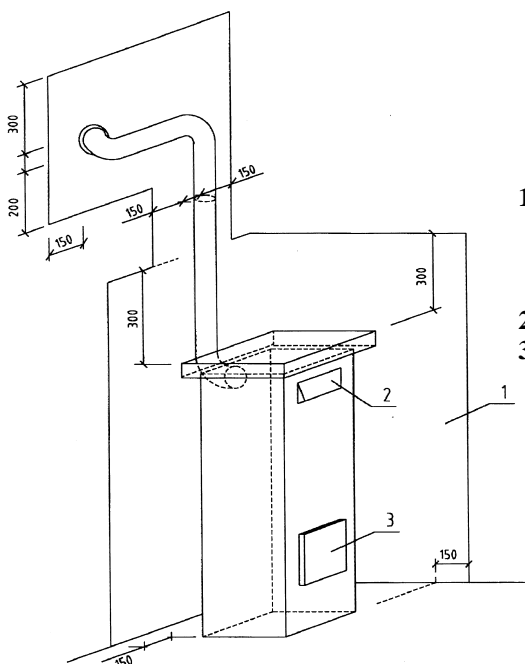

- 1 - protective shield of the appliance or flue protecting the surrounding combustible structural structures of reaction class to fire B, C, D, E or F
- 2 - stokers hole
- 3 - ash hole

Protective screen must be at least **3 mm** thick. Safe distance using a protective screen can be reduced by up to half.

- under the Ministry of Interior Decree No. 401 / 2007 Coll the safe distance the flue and the appliance from building constructions from materials of reaction class to fire B, C, D, E or F, flammable items and flammable substances are 800 mm in all directions.

**By the control of the boiler the operation shall comply with service-related regulations and standards, in particular, STN 34 1010 and the following principles:**

- a) During operation of the boiler must not be made on electrical equipment and electrical installation of the boiler interference such as :
  - fuses replacement and uncovering of electrical equipment such as electronic controller, the fan
  - the repair of damaged cable insulation and the like.
- b) repair and maintenance of the boiler, which requires uncovering of electrical parts of the boiler, may be done only by authorized person in according to Decree 718/2002 Coll
- c) Before removing the cover of the boiler or any electrical device connected to the boiler must be disconnected all power cords and voltage supply of the boiler from the main through pulling from the mains. Their reintegration is possible only after placing of the covers at the original location of the boiler.
- ci) the event of electrical equipment malfunction or damage to the boiler installation is necessary :
  - do not touch any part of the boiler
  - the boiler immediately disconnect from the mains through pulling the voltage supply from the mains
  - call trained service technician to remove the damage

## 6. DISPOSAL OF THE PRODUCT AFTER END OF LIFE

The product is constructed of materials, which waste has no hazardous characteristics. Disposal of individual parts is to be made by clean and ecological way.

At the end of life incurred the following main types:

1. Steel boiler body, cover, grids
2. Isover thermal insulation of the boiler, sealing snort Sibril
3. Refractory concrete parts of the chamber, doors isolation
4. The electronic controller with sensors

Product disposal is carried out as follows:

1. Boiler prior to disposal properly emptied of ash, which we store into the rubbish bin
2. Steel waste we deliver to places, where it is permitted to store such a waste
3. Refractory concrete parts of the chamber, insulation and controller we deliver to an approved dumping ground.

## 7. WARRANTY CONDITIONS

1. MTH Ltd. guarantee the product ZEUS PYRO for its faultless function for a period of 24 months from putting into operation, but maximum period of 30 months from the date of manufacture
2. The conditions of guarantee recognition is putting the boiler ZEUS PYRO into operation by trained service company in the branch of heating and boiler installation, usually closest to the operation of the boiler
3. Recognition of the condition of the warranty period is the equipment of heating system with control technology guidance under this.
4. In the warranty are entitled defects repair for free. Components replaced under warranty are the property of the producer
5. By the claim must be submitted a letter of guarantee, certificate of putting the boiler ZEUS PYRO into operation by trained service company, otherwise the claim is not recognized.
6. The warranty covers all defects ZEUS PYRO boiler and its components that are unusable due to poor quality material or faulty processing
7. The warranty does not apply to defects resulting non-compliance in the instructions for installation, operation and maintenance, or by ZEUS PYRO boiler is used other than in the manner and for any

- purpose other than for which it is intended under normal conditions, poor or improper handling eg. improper storage, improper handling, improper use of the fuel
8. The warranty does not apply to defects caused by impurities in the fuel, in the heating water, bad combustion gas offtake, the wrong location and the damage caused by the inevitable event (natural disaster, etc.). Warranty also does not apply to consumables: door seals, refractory concrete nozzle, refractory concrete bricks and fireclay bricks
  9. The warranty also does not apply to damages caused indirectly, and damage or personal injury cases.
  10. Claims for warranty also expire by breach of warranty, the expiry of the warranty period, repair or modification of the boiler ZEUS PYRO by unauthorized person, a breach of control marks or seals
  11. The cost of the service by sending a worker to rectify boiler ZEUS PYRO not covered by the guarantee shall be paid by the customer - the user of the boiler
  12. Responsibility for error – the warranty applies the customer by the company, which put into operation the boiler ZEUS PYRO or by any other trained company usually closest to the operation of the boiler ZEUS PYRO
  13. Damages and defects resulting from transfer the customer shall apply by the carrier's intake
  14. The obligation to at least 1x a year left to make a inspection of the boiler, including the setting and control of structural elements – confirm in the letter of guarantee
  15. Other rights and obligations arising from liability for defects in the boiler ZEUS PYRO be governed by the provisions of generally binding regulations in force in the Slovak Republic (Civil Code, Commercial Code, etc.)

## 8. POSSIBLE FAILURE AND ITS REPAIRING MOŽNÉ ZÁVADY A ICH RIEŠENIE

Fault	Reason	Way of repair
<b>The regulator can not turn on</b>	- no voltage in the network	- check
	- badly inserted into the plug socket	- check
	- broken regulator	- change
	- power cord is damaged	- change
<b>The boiler does not meet the required parameters</b>	- not enough water in the system	- add
	- high performance of the pump	- adjust the pump flow rate and switching
	- power boiler is not sufficiently dimensioned for the system	- badly prepared project
	- the fuel of low caloric value, moisture content Of wood is higher then 20%	- burn recommended fuel, ie dry wood with a moisture content of 20% and halved logs
	- not seal the firing flap	- repair, respectively. flap close, see. 1.3.4
	- a small chimney draft	- new chimney, inappropriate connection
	- a large chimney draft	- put the throttle flap into the chimney
	- long firing – curved fly of the circulation wheel or tar building	- straighten the fly to an angle of 90 ° and remove the tar from the surrounding area
	- long firing – curved fly of the circulation wheel	- replace the circulation wheel and clean the fan chamber
	- inadequately cleaned boiler	- clean
	- the nozzle clogs	- do not burn small wood and bark. Clean the nozzle
- clogged air supply into the combustion chamber	- check and clean	

<b>High temperature water boilers and low water temperature in the heating system</b>	- A large hydraulic resistance of the heating system	- check, if the network is not clogged and adjust pump speed
	- the mixing valve behind the boiler is incorrectly set up	- adjust the settings
<b>High water temperature in the boiler</b>	- a large chimney draft	- adjust the temperature of the boiler and air supply
<b>Door leak</b>	- bad gasket	- replace - set the hanging listel of the door
<b>Excessive clogging of the boiler combustion and firing space, the chamber of the fan and fan</b>	- oversized boiler power	
	- low water temperature in the boiler	- increase the output boiler water temperature so that the return water temperature is not lower than 60 °C
	- the fuel of low caloric value, moisture content of wood is higher than 20%	Recommende fuel burn, dry wood with a moisture content of 20% and halved logs
	- the boiler is poorly connected to the chimney - the tube connecting with knees is too long - the boiler has sufficient supply of primary air for combustion	- fix connection to the boiler chimney in accordance with Chapter 3.4
<b>Fan is noisy</b>	- Clogged circulation wheel	- clean sediment from the fan
	- damaged engine fan	- change
<b>The fan is not spinning</b>	- the set temperature of the boiler	
	- the boiler is overheated – activation of the security thermostat	- Wait until the temperature dropped to around and press any key
	- clogged circulation wheel	- clean sediment from the fan
	- broken capacitor	- change
	- a broken fan motor	- change
	- no voltage in the network	- check
	- the fan power cord is damaged	- replace
- damaged boiler controller	- replace the controller	

**EC - DECLARATION OF CONFORMITY M17-10-08/26-42**  
**under the provisions of Act no. 264 / 1999 Code, as amended**

**Company name :** MTH, Ltd.  
**Seat :** Šúrská 5, 900 01 MODRA – SLOVAKIA  
**Identification number:** 35 931 850

as producer of following product

**Name :** Hot water boiler for wood with manual fuel supply  
**Typy :** ZEUS PYRO  
**Design :** ZEUS PYRO 26, ZEUS PYRO 30, ZEUS PYRO 36, ZEUS PYRO 42;

**Product description :**

Steel hot water boiler for wood burning, designed for central heating of buildings as well as for heating of warm water

**The manufacturer states that :**

- A. The product is safe when used as intended and adopted measures, which is ensured by conformity all products placed on the market, are in accordance with technical documentation and the basic requirements of government that apply to it.
- B. Features of this product meets the technical requirements for the product and relate to:
- Directive Nr.97/23/ES ( Government Regulation Nr.26/2003), Directive 2006/95/EC (Government Regulation Nr.17/2003), Directive 2004/108/EC (Government Regulation Nr.616/2006 Coll.), regulations Government Nr.148/2006 Coll.
  - Standards: EN 303-5:2000 STN, CSN EN 13501-1 -
  - Standards: CSN 06 1008:1997, CSN EN 60335-1 ed.2: 2003, CSN EN 60335-2-102:2007, CSN EN 50165-1, ČSN EN 55014-1, ČSN EN 55014-2
- C. Conformity assessment was carried out by:
- Annex III - Module B1 of direction (B1 procedure under point 4 of Annex 3 of the government)
- D. Declaration of conformity assessment is issued under:  
Certificates of type. E-30-00837-08 and Č.B-30-00830-08 dated 17.10.2008 issued by the Engineering Machinery Test Institute in Brno, Czech Republic, an authorized person.
- E. Products mentioned types can be identified by depicting a sign marking CE 1015.

*In Modre, the day 17.10.2008*

*Dipl.Ing.Henrich Balejík  
Managing director MTH Ltd.*

**WARRANTY AND CERTIFICATE OF QUALITY AND COMPLETENESS**

**STEEL HOT WATER BOILER FOR PYROLITIC WOOD BURNING**

**MODRATHERM ZEUS PYRO**

Manufacturer : MTH s.r.o.  
Šúrska 5  
900 01 Modra  
tel.: +421 33 647 2314, fax: +421 33 647 3846  
e-mail : [odbyt@modratherm.sk](mailto:odbyt@modratherm.sk)  
<http://www.modratherm.sk>

Boiler:

**ZEUS PYRO 26**

**ZEUS PYRO 30**

**ZEUS PYRO 36**

**ZEUS PYRO 42**

Serial number:

Date of manufacture:

Seal and signature of the final inspection:

**CE 1015**

This warranty replaces the certificate of quality and completeness of the product. The manufacturer confirmed that the hot water boiler ZEUS PYRO satisfies STN 07 0240, STN 07 0245, CSN EN 303 - 5

**RECORD OF BOILERS PUTTED INTO OPERATION**

Production number : ..... Costumer :  
 Firstname : .....

Date of puting into the operation : ..... Surname : .....

Service organization : Street : .....

Town, zip-code : .....

..... Tel : .....

seal and signature

**RECORD OF MAINTENANCE AND REPAIR**

Date	Work done	Service company	Errors	Costumer signature



# RECOMMENDED SCHEME FOR CONNECTION OF THE GASIFYING BOILER

# ZEUS PYRO

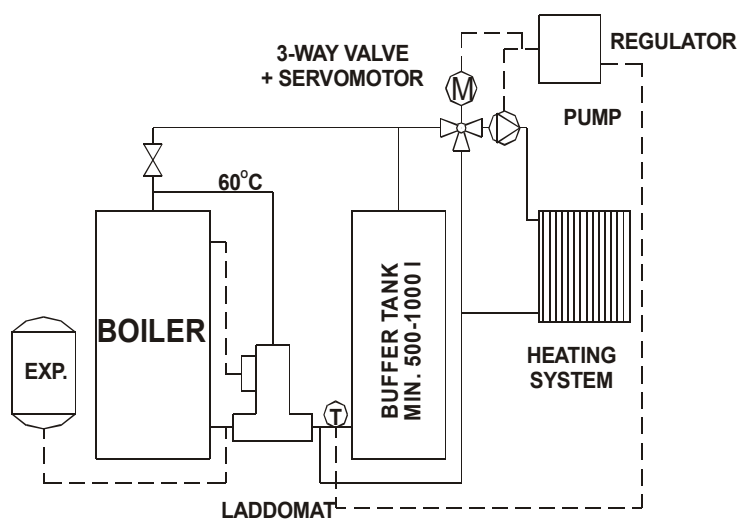

MTH s.r.o.  
900 01 Modra, Šúrska ul.č.5  
Tel.: 00421 /33/ 6472314  
Fax.: 0042 /33/ 6473846  
e-mail: mth@modratherm.sk  
<http://www.modratherm.sk>

Edition: september 2008

## Recommended scheme for connection of the boiler

Dear customer,

thank you, that you chose to purchase our product. . We believe that its parameters, performance and operational reliability will use you to maximum satisfaction.

Carefully study the options recommended by the hydraulic connection of the boiler and insist on their implementation.

Without using the required control equipment can significantly shorten the life of the boiler.

Without the use of additional control equipment we do not guarantee the boiler.

In the case of any ambiguity, please contact us on telephone numbers.

Sincerely : 

### **WARNING!**

**Without using the required control equipment can significantly shorten the life of the boiler.  
Without the use of additional control equipment we do not guarantee the boiler**

**Minimum volume of buffer tanks for 26 kW boiler is recommended for 1500-2000 lit, it means 60-80. to 1 kW. If you can not have the recommended volume of buffer tanks, connect the boiler at least with one buffer tank with volume from 500 to 1000 liters.**

These regulatory circuits are beyond the base regulation of the boiler.

### **SCHEME Nr.1**

#### **1. Regulation of temperature of return water to the boiler and charging the buffer tanks (position 4):**

- 3-way flap Nr.1,
- temperature sensors T1, T2
- pump Č1

at temperature T2 > 50°C – flow through the tank Nr.4

at temperature T2 < 50°C – flow through the short circuit

at temperature T1 < 50°C – pump Č1 – shut down

at temperature T1 > 50°C - pump Č1 – put into service

#### **2. Control of 3-way flap Nr.2 (used to accelerate the firing)**

- 3-way flap Nr.2
- temperature sensor T4
- temperature sensor T1

when the temperature reaches T4=85 °C, flow through the tank

at T4 < T7 – flow through the boiler – firing\*

( alternative – if can not be ensured „\*“ - than at T4<60 °C – flow through the boiler – firing)

#### **3. Equithermic heating regulation 85/65 °C**

according to the selected heating curve controll the three-way flap Nr.3, ie to regulate the temperature T7

- 3-way flap Nr.3
- pump Č3
- external (outdoor) temperature sensor T6
- heating water temperature sensor T7
- interior space temperature sensor Ti1(in reference room)

at temperature  $T_9 < 50^\circ\text{C}$  - pump Č3 shut down  
 at temperature  $T_9 > 50^\circ\text{C}$  – pump put into service

**4. Equithermic heating regulation 45/35 °C**

according to the selected heating curve controll the three-way flap Nr.3, ie to regulate the temperature T8

- 3-way flap Nr.4
- pump Č4
- external (outdoor) temperature sensor T6
- heating water temperature sensor T8
- interior space temperature sensor Ti2(in reference room)
- at temperature  $T_9 < 50^\circ\text{C}$  - pump Č4 shut down
- at temperature  $T_9 > 50^\circ\text{C}$  – pump put into service

**5. Warm water heating**

- pump Č2
- temperature sensor T3
- temperature sensor T1
- at temperature  $T_3 < 50^\circ\text{C}$  pump put into service
- at temperature  $T_3 = 65 \text{ až } 80^\circ\text{C}$  pump shut down
- at temperature  $T_9 < 50^\circ\text{C}$  run of the pump is blocked

**6. Temperature indicating**

Temperatures T1 .... T9 a Te (external – outdoor) temperature Ti (indoor temperature) show on the display

**8. Frost protection**

at low temperature in some reference room Ti1, or  $Ti_2 < 5^\circ\text{C}$  – all the pumps put into operation.

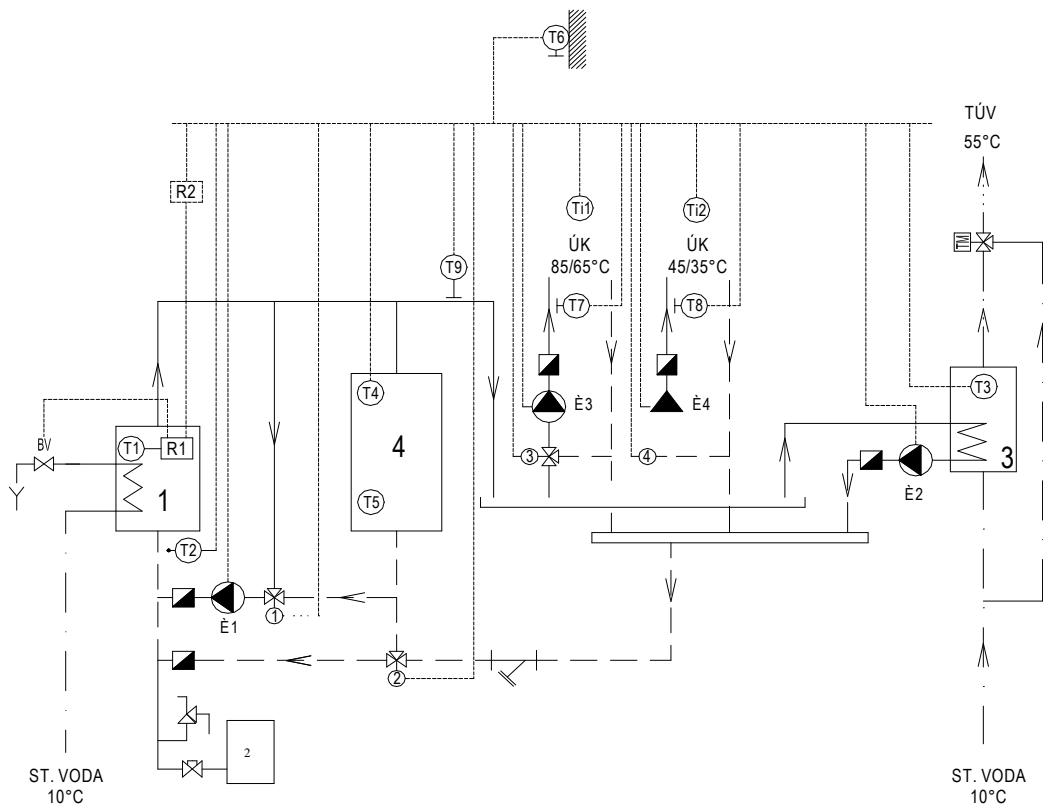

## **SCHEME Nr.2**

### **1. Regulation of temperature of return water to the boiler and charging the buffer tanks (position 4):**

- 3-way flap Nr.1,
  - temperature sensors T2
  - pump Č1
- at temperature  $T2 > 50^{\circ}\text{C}$  – flow through the tank Nr.4  
at temperature  $T2 < 50^{\circ}\text{C}$  – flow through the short circuit  
at temperature  $T1 < 50^{\circ}\text{C}$  – pump Č1 – shut down  
at temperature  $T1 > 50^{\circ}\text{C}$  - pump Č1 – put into service

### **2. Control of 3-way flap Nr.2 (used to accelerate the firing)**

- 3-way flap Nr.2
  - temperature sensor T4
  - temperature sensor T1
- when the temperature reaches  $T4=80^{\circ}\text{C}$ , flow through the tank  
at  $T4 < T7$ (resp.  $T6$ ) – flow through the boiler – firing

### **3. Equithermic heating regulation 85/65 °C**

- according to the selected heating curve controll the three-way flap Nr.3,
- 3-way flap Nr.3
  - pump Č3
  - external (outdoor) temperature sensor T6
  - heating water temperature sensor T7
  - interior space temperature sensor Ti1(in reference room) – a part of regulator R2
- at temperature  $T1 < 50^{\circ}\text{C}$  - pump Č3 shut down  
at temperature  $T1 > 50^{\circ}\text{C}$  – pump put into service

### **4.**

### **5. Warm water heating**

- pump Č2
  - temperature sensor T3
  - temperature sensor T1
- at temperature  $T3 < 50^{\circ}\text{C}$  pump put into service  
at temperature  $T3 = 65$  až  $80^{\circ}\text{C}$  pump shut down  
at temperature  $T1 < 50^{\circ}\text{C}$  run of the pump is blocked

### **6. Temperature indicating**

Temperatures T1 .... T8 a Te (external – outdoor) temperature Ti (indoor temperature) show on the display

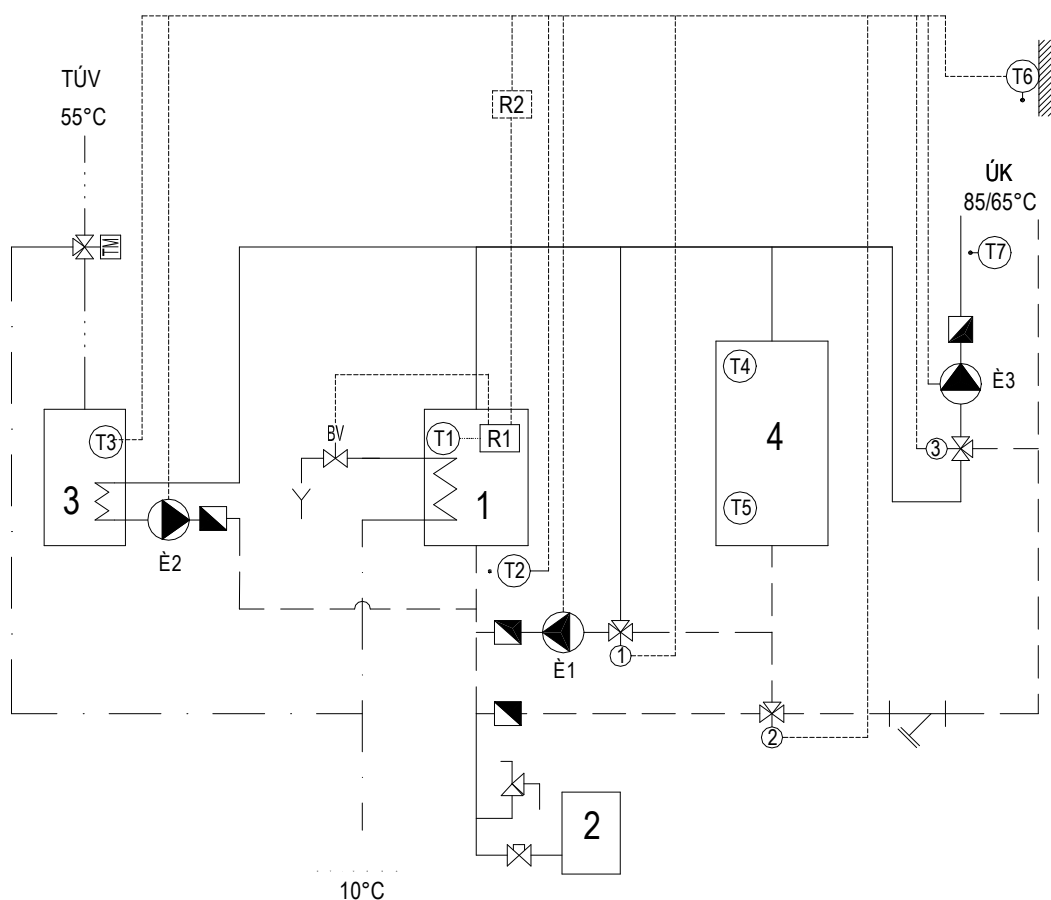

### SCHEME Nr.3

#### **1. Regulation of temperature of return water to the boiler:**

- 3-way flap Nr.1,
- temperature sensors T2
- pump Č1
- at temperature  $T2 > 50^{\circ}\text{C}$  – flow through the tank Nr.4
- at temperature  $T2 < 50^{\circ}\text{C}$  – flow through the short circuit
- at temperature  $T1 < 50^{\circ}\text{C}$  – pump Č1 – shut down
- at temperature  $T1 > 50^{\circ}\text{C}$  - pump Č1 – put into service

#### **2. Manual control of charging the buffer**

- by firing is the the buffer closed

#### **3. Equithermic heating regulation 85/65 °C**

according to the selected heating curve controll the three-way flap Nr.3

- 3-way flap Nr.3
- pump Č3
- external (outdoor) temperature sensor T6
- heating water temperature sensor T7
- interior space temperature sensor (in reference room) – a part of regulator R2

at temperature  $T1 < 50^{\circ}\text{C}$  - pump Č3 shut down  
 at temperature  $T1 > 50^{\circ}\text{C}$  - pump put into service

4.

#### 5. Warm water heating

- pump Č2

- temperature sensor T3

- temperature sensor T1

at temperature  $T3 < 50^{\circ}\text{C}$  pump put into service

at temperature  $T3 = 65 \text{ až } 80^{\circ}\text{C}$  pump shut down

at temperature  $T1 < 50^{\circ}\text{C}$  run of the pump is blocked

#### 6. Temperature indicating

Temperatures  $T1 \dots T8$  a  $T_e$  (external – outdoor) temperature  $T_i$  (indoor temperature) show on the display

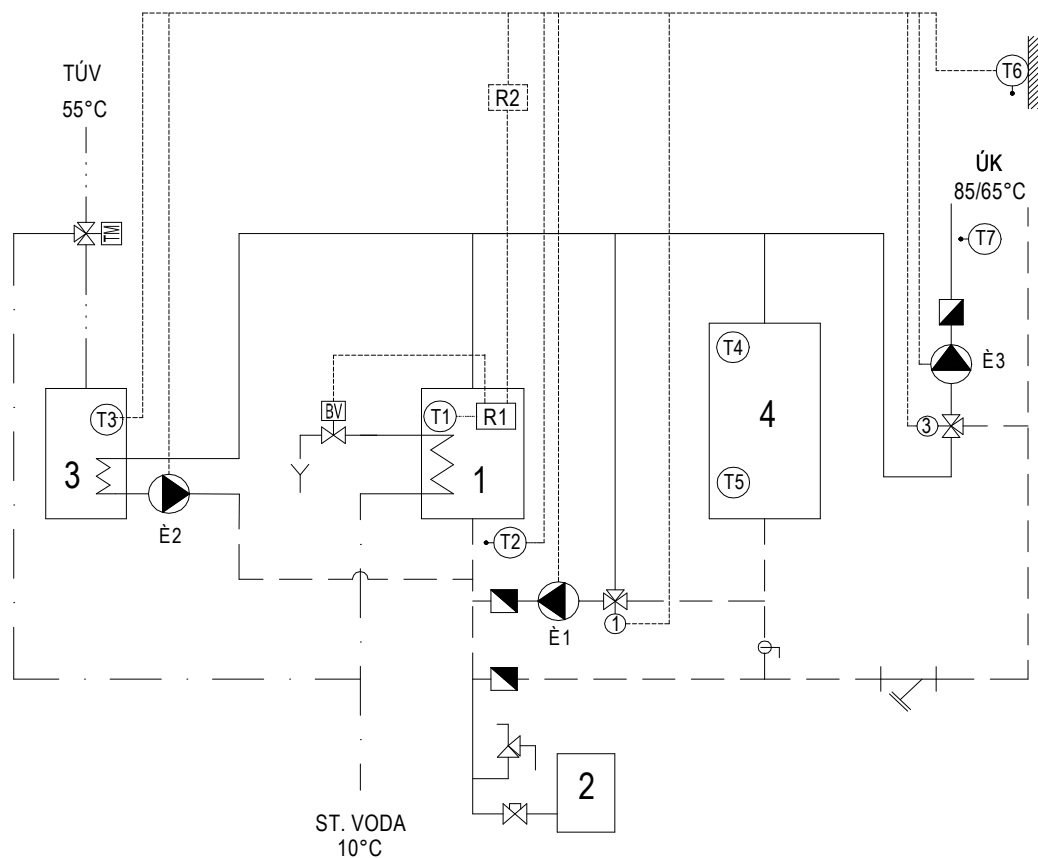

**SCHEME Nr.4****1. Regulation of temperature of return water to the boiler:**

- temperature sensors T2
- pump Č1

at temperature  $T1 < 50^{\circ}\text{C}$  – pump Č1 – shut down  
 at temperature  $T1 > 50^{\circ}\text{C}$  - pump Č1 – put into service

**2.****3. Equithermic heating regulation 85/65 °C**

according to the selected heating curve controll the three-way flap Nr.3

- 3-way flap Nr.3
- pump Č3
- external (outdoor) temperature sensor T6
- heating water temperature sensor T7
- interior space temperature sensor (in reference room) – a part of regulator R2
- at temperature  $T1 < 50^{\circ}\text{C}$  - pump Č3 block
- at temperature  $T1 > 50^{\circ}\text{C}$  – pump in operation

**4.****5. Warm water heating**

- pump Č2
- temperature sensor T3
- temperature sensor T1
- at temperature  $T3 < 50^{\circ}\text{C}$  pump put into service
- at temperature  $T3 = 65 \text{ až } 80^{\circ}\text{C}$  pump shut down
- at temperature  $T1 < 50^{\circ}\text{C}$  run of the pump is blocked

**6. Temperature indicating**

Temperatures T1 .... T8 a Te (external – outdoor) temperature Ti (indoor temperature) show on the display

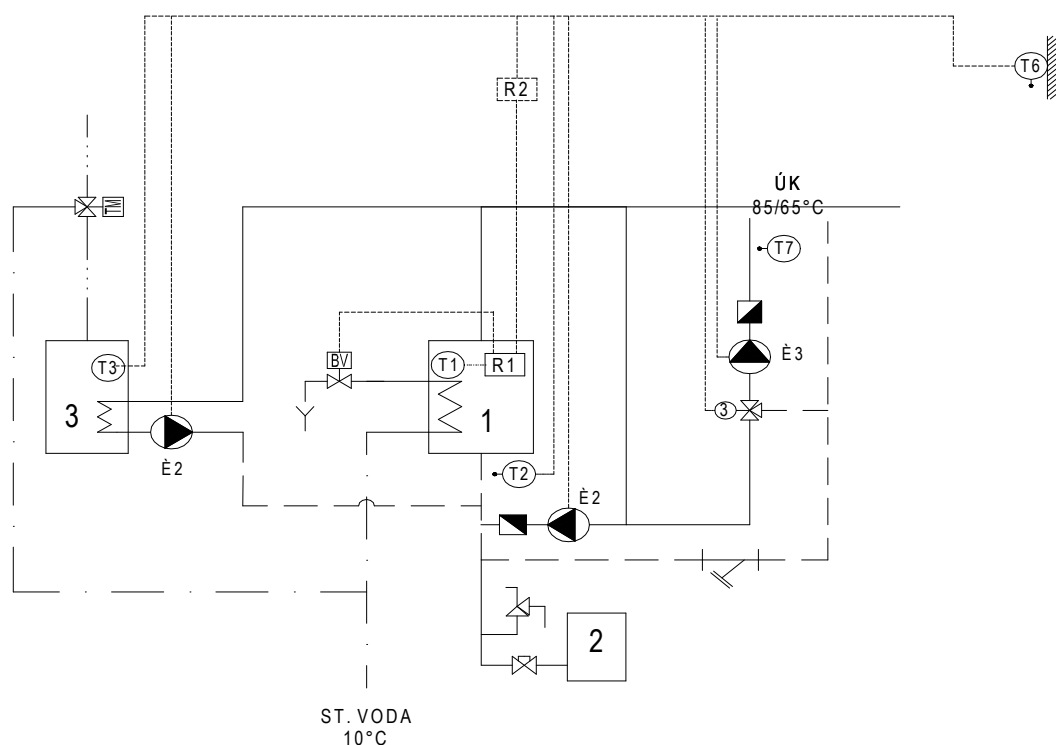

**SCHEME Nr.5****1. Regulation of temperature of return water to the boiler :**

- temperature sensors T2
- pump Č1

at temperature  $T1 < 50^{\circ}\text{C}$  – pump Č1 – shut down

at temperature  $T1 > 50^{\circ}\text{C}$  - pump Č1 – put into service

2.

**3. Equithermic heating regulation 85/65 °C**

according to the selected heating curve controll the three-way flap Nr.3

- 3-way flap Nr.3
- pump Č3
- external (outdoor) temperature sensor T6
- heating water temperature sensor T7
- interior space temperature sensor (in reference room) – a part of regulator R2
- at temperature  $T1 < 50^{\circ}\text{C}$  - pump Č3 block
- at temperature  $T9 > 50^{\circ}\text{C}$  – pump in operation

4.

5.

**6. Temperature indicating**

Temperatures T1 .... T8 a Te (external – outdoor) temperature Ti (indoor temperature) show on the display

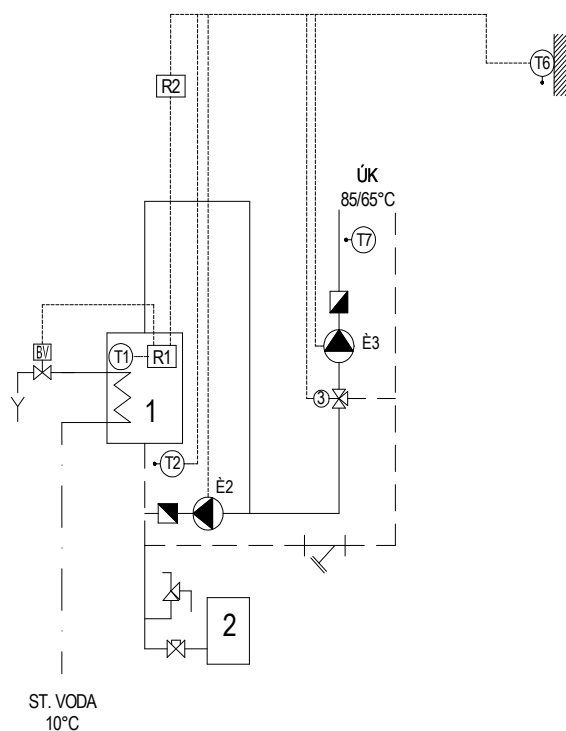







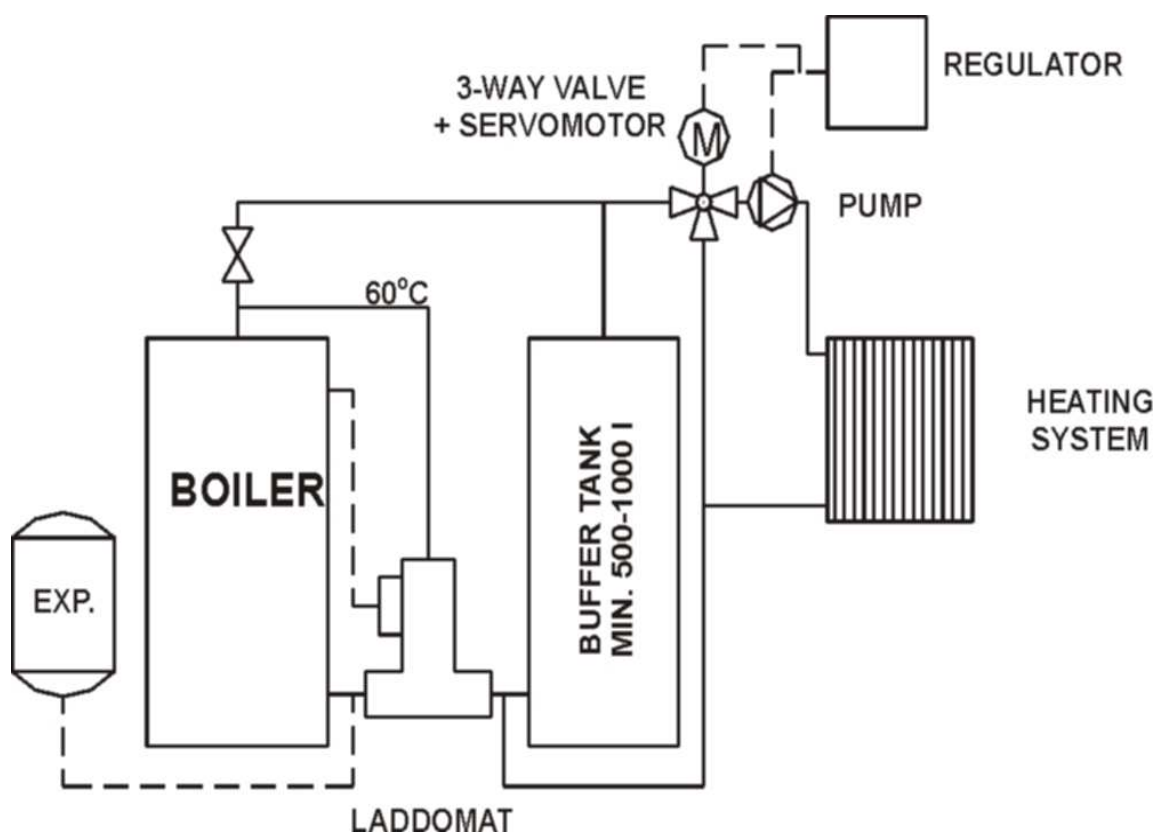

















**SCHEME Nr.6 Regulation with Laddomat and buffer tanks****■ Principe**

Control of water in the heating system is automatically with decoding device of compared temperatures and servomotor on the mixingag valve. The temperature of heating water in the system is controlled by the regulator on the ground the outside temperature is scanned. Excess heat from the boiler can be diverted to the buffer tanks.

**■ Advantages**

- ✓ comprehensive solution and quality regulation
- ✓ high comfort and high savings
- ✓ temperature regulation of return water to the boiler
- ✓ temperature regulation of heating water within system
- ✓ solution of levy of surplus boiler power
- ✓ drawings of the accumulated heat from the buffer tanks
- ✓ longer life of the boiler and whole heating system

## LEGENDA

1	KOD
2	BEZMĚŘENÍ
3	ZŠIKMŮV
4	VÝKONOVÝ ZŠIKMŮV
	PRŮMĚRNÝ PRŮTOK
	E
	ORIGINÁLV
	SKUPINOVÝ
	ČERPADLO
	TEPELNÝ ČERPADLO
	BEZMĚŘENÍ
	TEPELNÝ ČERPADLO
	PRŮTOK
	SPRÁVČÍ
	SPRÁVČÍ
	PRŮTOK
	ČERPADLO
	SPRÁVČÍ
	ČERPADLO
	PRŮTOK
	PRŮTOK
	PRŮTOK
	PRŮTOK
	PRŮTOK
	PRŮTOK
	PRŮTOK

**WARNING!**

Sizing of the expansion tank, boiler power, buffer tanks and pumps must be done by a skilled project engineer.

While in the heating system will be installed plastic piping, the boiler producer takes no responsibility for eventual damage on piping, pump and others.

**WARNING!**

In the scheme 1 – 5 can be the sensor of outside temperature T6 of equithermic regulation substituted with sensor of indoor temperature, ie the system regulation will be provided by an indoor regulator

Regulation of heating system can be solved with equithermic regulation with a sensor of outside temperature or with an indoor regulator.