

SERVICE MANUAL

[Model Name]
EHSD-MED
EHSD-VM2D
EHSD-VM6D
EHSD-YM9D
EHSD-YM9ED
EHSD-TM9D
ERSD-MED
ERSD-VM2D
ERSD-VM6D
ERSD-YM9D
EHSC-MED
EHSC-VM2D
EHSC-VM6D
EHSC-YM9D
EHSC-YM9ED
EHSC-TM9D
ERSC-MED
ERSC-VM2D
ERSC-VM6D
ERSC-YM9D
EHSE-MED
EHSE-YM9ED
ERSE-MED
ERSE-YM9ED
EHPX-VM2D
EHPX-VM6D
EHPX-YM9D
EHPX-MED
EHPX-YM9ED
ERPX-MD
ERPX-VM2D
ERPX-VM6D
ERPX-YM9D
Revision:

- ERSD-VM6D, ERSD-YM9D, ERSC-VM6D, ERSC-YM9D and ERPX series have been added.
- Some descriptions have been modified in REVISED EDITION-C.

OCH712B is void.

Note:

- This manual describes service data of Hydrobox only.

[Service Ref.]

Refer to page 2.

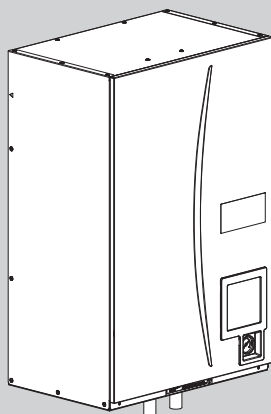

HYDROBOX

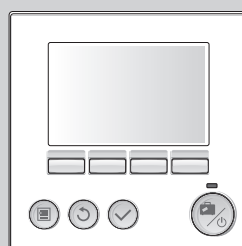
 MAIN REMOTE
CONTROLLER

CONTENTS

1. REFERENCE MANUAL.....	3
2. SAFETY PRECAUTION.....	4
3. SPECIFICATIONS.....	6
4. PART NAMES AND FUNCTIONS	8
5. OUTLINES AND DIMENSIONS.....	9
6. WIRING DIAGRAM.....	11
7. FIELD WIRING.....	17
8. WATER SYSTEM DIAGRAM.....	19
9. CONTROLS	22
10. TROUBLESHOOTING.....	43
11. DISASSEMBLY PROCEDURE	60
12. SUPPLEMENTARY INFORMATION	80
13. SERVICE AND MAINTENANCE	81

PARTS CATALOG (OCB712)

[Service Ref.]

EHSD-MED.UK
EHSD-VM2D.UK
EHSD-VM6D.UK
EHSD-YM9D.UK
EHSD-YM9ED.UK
EHSD-TM9D.UK
ERSD-MED.UK
ERSD-VM2D.UK
ERSD-VM6D.UK
ERSD-YM9D.UK
EHSC-MED.UK
EHSC-VM2D.UK
EHSC-VM6D.UK
EHSC-YM9D.UK
EHSC-YM9ED.UK
EHSC-TM9D.UK
ERSC-MED.UK
ERSC-VM2D.UK
ERSC-VM6D.UK
ERSC-YM9D.UK
EHSE-MED.UK
EHSE-YM9ED.UK
ERSE-MED.UK
ERSE-YM9ED.UK
EHPX-VM2D.UK
EHPX-VM6D.UK
EHPX-YM9D.UK
EHPX-MED.UK
EHPX-YM9ED.UK
ERPX-MD.UK
ERPX-VM2D.UK
ERPX-VM6D.UK
ERPX-YM9D.UK

OUTDOOR UNIT'S SERVICE MANUAL

	Service Ref.	Service Manual No.
Split model	SUZ-SWM40VA.TH SUZ-SWM60VA.TH SUZ-SWM80VA.TH	OCH718 OCB718
	PUHZ-FRP71VHA2 PUHZ-FRP71VHA2R1	OCH665 OCB665
	PUHZ-SW120VHAR5(-BS).UK PUHZ-SW120YHAR5(-BS).UK	OCH533 OCB533
	PUHZ-SHW140YHAR5(-BS).UK	OCH526 OCB526
	PUHZ-SW160YKAR1(-BS).UK PUHZ-SW200YKAR1(-BS).UK	OCH583 OCB583
	PUHZ-SHW230YKA2R2	OCH594 OCB594
	PUHZ-SHW80VAA(-BS).UK PUHZ-SHW80YAA(-BS).UK PUHZ-SHW112VAA(-BS).UK PUHZ-SHW112YAA(-BS).UK PUHZ-SW75VAA(-BS).UK PUHZ-SW75YAA(-BS).UK PUHZ-SW75VAA-SC.UK PUHZ-SW75YAA-SC.UK PUHZ-SW100VAA(-BS).UK PUHZ-SW100YAA(-BS).UK	OCH651 OCB651
	PUMY-P112VKM4R4(-BS).UK PUMY-P125VKM4R4(-BS).UK PUMY-P140VKM4R4(-BS).UK PUMY-P112YKM4R4(-BS).UK PUMY-P125YKM4R4(-BS).UK PUMY-P140YKM4R4(-BS).UK PUMY-P112YKME4R4(-BS).UK PUMY-P125YKME4R4(-BS).UK PUMY-P140YKME4R4(-BS).UK	OCH673 OCB673
	PUD-SWM60VAA(-BS).UK PUD-SWM80VAA(-BS).UK PUD-SWM80YAA(-BS).UK PUD-SWM100VAA(-BS).UK PUD-SWM100YAA(-BS).UK PUD-SWM120VAA(-BS).UK PUD-SWM120YAA(-BS).UK PUD-SHWM60VAA(-BS).UK PUD-SHWM80VAA(-BS).UK PUD-SHWM80YAA(-BS).UK PUD-SHWM100VAA(-BS).UK PUD-SHWM100YAA(-BS).UK PUD-SHWM120VAA(-BS).UK PUD-SHWM120YAA(-BS).UK PUD-SHWM140YAA(-BS).UK	OCH694 OCB694
	Packaged model	PUZ-WM50VHA(-BS).UK PUZ-WM60VAA(-BS).UK PUZ-WM85VAA(-BS).UK PUZ-WM85YAA(-BS).UK PUZ-WM112VAA(-BS).UK PUZ-WM112YAA(-BS).UK
PUZ-HWM140VHA(-BS) PUZ-HWM140YHA(-BS)		OCH748 OCB748

Please read the following safety precautions carefully.





⚠ WARNING:
Precautions that must be observed to prevent injuries or death.

⚠ CAUTION:
Precautions that must be observed to prevent damage to unit.

Mitsubishi Electric is not responsible for the failure of locally-supplied parts.

- Be sure to perform periodical maintenance.
- Be sure to follow your local regulations.
- Be sure to follow the instructions provided in this manual.

MEANINGS OF SYMBOLS DISPLAYED ON THE UNIT

	WARNING (Risk of fire)	This mark is for R32 refrigerant only. Refrigerant type is written on nameplate of outdoor unit. In case that refrigerant type is R32, this unit uses a flammable refrigerant. If refrigerant leaks and comes in contact with fire or heating part, it will create harmful gas and there is risk of fire.
		Read the OPERATION MANUAL carefully before operation.
		Service personnel are required to carefully read the OPERATION MANUAL and INSTALLATION MANUAL before operation.
		Further information is available in the OPERATION MANUAL, INSTALLATION MANUAL, and the like.

⚠ ⚠ WARNING

Mechanical

- The hydrobox and outdoor units must not be installed, disassembled, relocated, altered or repaired by the user. Ask an authorised installer or technician. If the unit is installed improperly or modified after installation by the user water leakage, electric shock or fire may result.
- The outdoor unit should be securely fixed to a hard level surface capable of bearing its weight.
- The hydrobox should be positioned on a hard vertical surface capable of supporting its filled weight to prevent excessive sound or vibration.
- Do not position furniture or electrical appliances below the outdoor unit or hydrobox.
- The discharge pipework from the emergency/safety devices of the hydrobox should be installed according to local law.
- Only use accessories and replacement parts authorised by Mitsubishi Electric ask a qualified technician to fit the parts.

Electrical

- All electrical work should be performed by a qualified technician according to local regulations and the instructions given in this manual.
- The units must be powered by a dedicated power supply and the correct voltage and circuit breakers must be used.
- Wiring should be in accordance with national wiring regulations. Connections must be made securely and without tension on the terminals.
- Earth unit correctly.
- Discharge the condenser before the work involving the electric parts.

General

- Keep children and pets away from both the hydrobox and outdoor units.
- Do not use the hot water produced by the heat pump directly for drinking or cooking. This could cause illness to the user.
- Do not stand on the units.
- Do not touch switches with wet hands.
- Annual maintenance checks on both the hydrobox and the outdoor unit should be conducted by a qualified person.
- Do not place containers with liquids on top of the hydrobox. If they leak or spill onto the hydrobox damage to the unit and/or fire could occur.
- Do not place any heavy items on top of the hydrobox.
- When installing, relocating, or servicing the hydrobox, use only the heat pump's specified refrigerant to charge the refrigerant lines. Do not mix it with any other refrigerant and do not allow air to remain in the lines. If air is mixed with the refrigerant, then it can be the cause of abnormal high pressure in the refrigerant line, and may result in an explosion and other hazards.
- The use of any refrigerant other than that specified for the system will cause mechanical failure or system malfunction or unit breakdown. In the worst case, this could lead to a serious impediment to securing product safety.
- In heating mode, to avoid the heat emitters being damaged by excessively hot water, set the target flow temperature to a minimum of 2°C below the maximum allowable temperature of all the heat emitters. For Zone2, set the target flow temperature to a minimum of 5°C below the maximum allowable flow temperature of all the heat emitters in Zone2 circuit.
- Do not install the unit where combustible gases may leak, be produced, flow, or accumulate. If combustible gas accumulates around the unit, fire or explosion may result.
- Do not use means to accelerate the defrosting process or to clean, other than those recommended by the manufacturer.
- The appliance shall be stored in a room without continuously operating ignition sources (for example: open flames, an operating gas appliance or an operating electric heater).
- Do not pierce or burn.
- Be aware that refrigerants may not contain an odour.
- Pipe-work shall be protected from physical damage.
- The installation of pipe-work shall be kept to a minimum.
- Compliance with national gas regulations shall be observed.
- Keep any required ventilation openings clear of obstruction.
- Do not use low temperature solder alloy in the case of brazing the refrigerant pipes.

⚠ CAUTION

Use clean water that meets local quality standards on the primary circuit.
The outdoor unit should be installed in an area with sufficient airflow according to the diagrams in the outdoor unit installation manual.
The hydrobox should be located inside to minimise heat loss.
Water pipe-runs on the primary circuit between outdoor and indoor unit should be kept to a minimum to reduce heat loss.
Ensure condensate from outdoor unit is piped away from the base to avoid puddles of water.
Remove as much air as possible from water circuit.
Refrigerant leakage may cause suffocation. Provide ventilation in accordance with EN378-1.
Be sure to wrap insulation around the piping. Direct contact with the bare piping may result in burns or frostbite.
Never put batteries in your mouth for any reason to avoid accidental ingestion.
Battery ingestion may cause choking and/or poisoning.
Install the unit on a rigid structure to prevent excessive sound or vibration during operation.
If power to the hydrobox is to be turned off (or system switched off) for a long time, the water should be drained.
Preventative measures should be taken against water hammer, such as installing a Water Hammer Arrestor on the primary water circuit, as directed by the manufacturer.
In order to prevent condensation on emitters, adjust flow temperature appropriately and also set the lower limit of the flow temperature on site.

As for the handling of refrigerant, refer to the outdoor unit installation manual.

[1] Cautions for service

- (1) Perform service after recovering the refrigerant left in unit completely.
- (2) Do not release refrigerant in the air.
- (3) After completing service, charge the cycle with specified amount of refrigerant.
- (4) If moisture or foreign matter might have entered the refrigerant piping during service, ensure to remove them.

[2] Additional refrigerant charge

When charging directly from refrigerant cylinder

- (1) Check that cylinder for R410A or R32 on the market is syphon type.
- (2) Charging should be performed with the cylinder of syphon stood vertically. (Refrigerant is charged from liquid phase.)

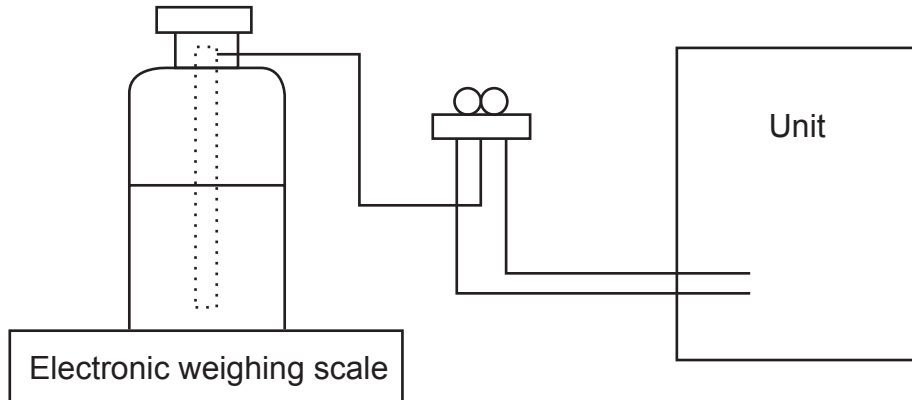

[3] Service tools

Use the service tools below as exclusive tools for R410A or R32 refrigerant.

No.	Tool name	Specifications
1	Gauge manifold	· R410A or R32
		· Use the existing fitting specifications. (UNF1/2)
		· Use high-tension side pressure of 5.3 MPa·G or over.
2	Charge hose	· R410A or R32
		· Use pressure performance of 5.09 MPa·G or over.
3	Electronic weighing scale	—
4	Gas leak detector	· Use the detector for R134a, R407C, R410A or R32
5	Adaptor for reverse flow check	· Attach on vacuum pump.
6	Refrigerant charge base	—
7	Refrigerant cylinder	· R410A or R32
		· Top of cylinder (Pink) · Cylinder with syphon
8	Refrigerant recovery equipment	—

Model name	EHSD-MED	EHSD-VM2D	EHSD-VM6D	EHSD-VM9D	EHSD-MED	ERSD-VM2D	ERSD-VM6D	ERSD-VM9D	EHSC-MED	EHSC-VM2D	EHSC-VM6D	EHSC-VM9D	EHSC-MED	ERSC-VM2D	ERSC-VM6D	ERSC-VM9D	
Overall unit dimensions (Height x Width x Depth)																	
Weight (empty)	36 kg	43 kg	44 kg	44 kg	44 kg	38 kg	44 kg	44 kg	40 kg	44 kg	44 kg	47 kg	48 kg	41 kg	48 kg	48 kg	
Weight (full)	38 kg	48 kg	49 kg	49 kg	49 kg	39 kg	49 kg	50 kg	42 kg	53 kg	54 kg	54 kg	54 kg	54 kg	54 kg	55 kg	
Water volume of heating circuit in the unit *1	1.7 L	5.2 L	5.2 L	5.2 L	5.2 L	1.7 L	5.2 L	5.2 L	2.6 L	6.1 L	6.1 L	6.1 L	6.1 L	6.1 L	6.1 L	6.1 L	
Unvented expansion vessel(Primary heating)	Nominal volume	—	10 L	—	10 L	—	10 L	—	—	10 L	—	10 L	—	—	10 L	—	
	Charge pressure	—	0.1 MPa (1 bar)	—	0.1 MPa (1 bar)	—	0.1 MPa (1 bar)	—	—	0.1 MPa (1 bar)	—	0.1 MPa (1 bar)	—	—	0.1 MPa (1 bar)	—	
Safety device	Control thermostat	80°C															
	Pressure relief valve	0.3 MPa (3 bar)															
	Flow sensor	Min. flow 5.0 L/min (See table 10.6.1 about water flow rate range)															
Booster heater	Manual reset thermostat	—	90°C	—	90°C	—	90°C	—	—	90°C	—	90°C	—	—	90°C	—	
	Thermal Cut-out (for dry run prevention)	—	121°C	—	121°C	—	121°C	—	—	121°C	—	121°C	—	—	121°C	—	
Connections	Water (primary circuit)	28 mm / Compression															
	Refrigerant (R32/ R410A)	G1-B															
Target temperature range	Liquid	Ø6.35 mm															
	Gas	Ø12.7 mm															
	Heating	20 - 60°C															
Guaranteed operating range	Cooling	5 - 25°C															
	Room temperature	10 - 30°C															
	Cooling	—															
Electrical data	Ambient *2	0 - 35°C (≤ 80 %RH)															
	Outdoor temperature	See outdoor unit spec table.															
Sound power level	Heating	—															
	Cooling	*3															
Control board (including 3 pumps)	Power supply (Phase, voltage, frequency)	~N, 230 V, 50 Hz															
	Breaker (*when powered from independent source)	10 A															
Booster heater	Power supply (Phase, voltage, frequency)	—	~N, 230 V, 50 Hz	3~ 230 V, 50 Hz	3~ 400 V, 50 Hz	—	~N, 230 V, 50 Hz	3~ 400 V, 50 Hz	—	~N, 230 V, 50 Hz	3~ 400 V, 50 Hz	—	~N, 230 V, 50 Hz	—	~N, 230 V, 50 Hz	3~ 400 V, 50 Hz	
	Capacity	—	2 kW	3 kW +6 kW	3 kW +6 kW	—	2 kW	3 kW +6 kW	—	2 kW	3 kW +6 kW	—	2 kW	3 kW +6 kW	2 kW	3 kW +6 kW	
	Current	—	9 A	26 A	13 A	—	9 A	26 A	13 A	—	9 A	26 A	13 A	—	9 A	26 A	
	Breaker	—	16 A	32 A	16 A	—	16 A	32 A	16 A	—	16 A	32 A	16 A	—	16 A	32 A	16 A
			41 dB(A)														
		40 dB(A)															

<Table 3.1>

*1 Piping to Expansion vessel is not included in this value.

*2 The environment must be frost-free.

*3 See outdoor unit spec table. (min. 10°C)

Cooling mode is not available in low outdoor temperature. If you use our system in cooling mode at the low ambient temperature (10°C or below), there are some risks of plate heat exchanger damages by frozen water.

Model name	ERSE-YM9D	ERSE-MED	EHSE-YM9D	EHSE-MED	EHPX-MED	EHPX-M2D	EHPX-VM6D	EHPX-YM9D	EHPX-MID	ERPX-VM2D	ERPX-VM6D	ERPX-YM9D
Overall unit dimensions (Height x Width x Depth)	800 x 530 x 360 mm											
Weight (empty)	64 kg	62 kg	63 kg	61 kg	25 kg	32 kg	33 kg	33 kg	30 kg	33 kg	34 kg	35 kg
Weight (full)	74 kg	72 kg	73 kg	71 kg	26 kg	36 kg	37 kg	38 kg	31 kg	37 kg	38 kg	39 kg
Water volume of heating circuit in the unit *1	10.0 L	10.0 L	10.0 L	10.0 L	1.0 L	4.5 L	4.5 L	4.5 L	1.0 L	4.5 L	4.5 L	4.5 L
Unvented expansion vessel (Primary heating)	—	—	—	—	—	—	—	—	—	—	—	—
Charge pressure	—	—	—	—	—	—	—	—	—	—	—	—
Control thermostat	0.1 MPa (1 bar)											
Water circuit (Primary)	80°C											
Pressure relief valve	0.3 MPa (3 bar)											
Flow sensor	Min. flow 5.0 L/min (See table 10.6.1 about water flow rate range)											
Manual reset thermostat	90°C	—	90°C	—	—	—	—	90°C	—	—	—	90°C
Thermal Cut-out (for dry run prevention)	121°C	—	121°C	—	—	—	—	121°C	—	—	—	121°C
Water (primary circuit)	28 mm / Compression											
Refrigerant (R32/R410A)	G1-1/2-B											
Liquid	Ø9.52 mm											
Gas	Ø25.4 mm (Brazing)											
Flow temperature	20 - 60°C											
Heating	—											
Cooling	—											
Room temperature	10 - 30°C											
Cooling	—											
Ambient *2	0 - 35°C (≤ 80 %RH)											
Guaranteed operating range	See outdoor unit spec table											
Heating	—											
Cooling	—											
Power supply (Phase, voltage, frequency)	~N, 230 V, 50 Hz											
Control board (Including 3 pumps)	10 A											
Breaker (*when powered from independent source)	—											
Power supply (Phase, voltage, frequency)	3~ , 400 V, 50 Hz	—	3~ , 400 V, 50 Hz	—	—	—	—	3~ , 400 V, 50 Hz	—	—	—	3~ , 400 V, 50 Hz
Capacity	3 kW +6 kW	—	3 kW +6 kW	—	—	2 kW	2 kW +4 kW	3 kW +6 kW	—	2 kW	2 kW +4 kW	3 kW +6 kW
Current	13 A	—	13 A	—	—	9 A	26 A	13 A	—	9 A	26 A	13 A
Breaker	16 A	—	16 A	—	—	16 A	32 A	16 A	—	16 A	32 A	16 A
Sound power level	45 dB(A)											
	40 dB(A)											

<Table 3.2>

*1 Piping to Expansion vessel is not included in this value.

*2 The environment must be frost-free.

*3 See outdoor unit spec table. (min. 10°C)

Cooling mode is not available in low outdoor temperature. If you use our system in cooling mode at the low ambient temperature (10°C or below), there are some risks of plate heat exchanger damages by frozen water.

<E*PX-*M**D> (Packaged model system)

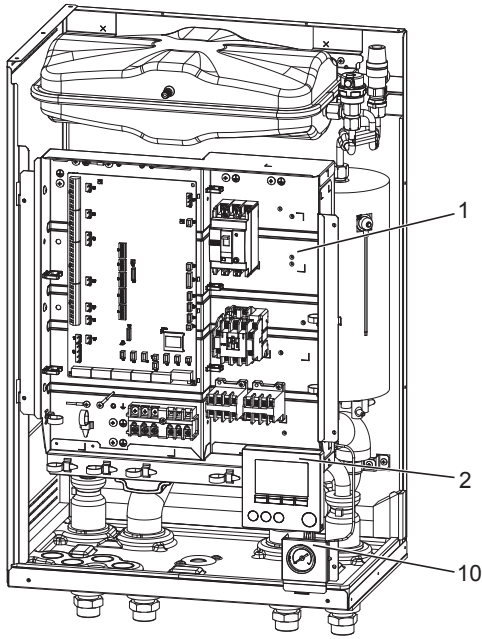

<Figure 4.1>

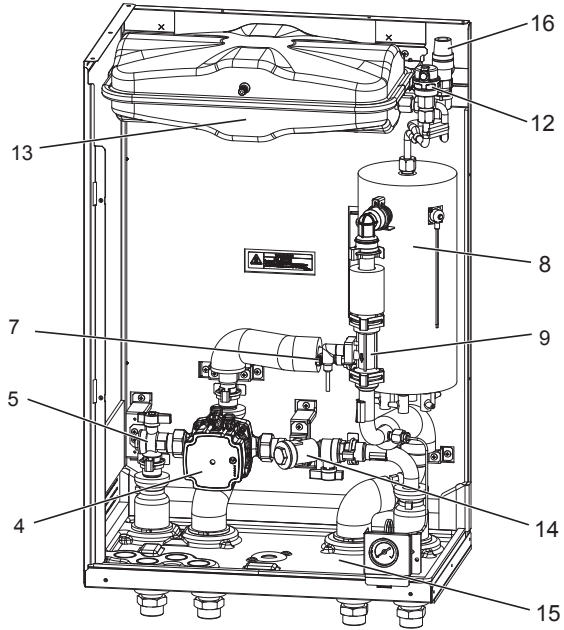

<Figure 4.2>

<E*S*-*M**D> (Split model system)

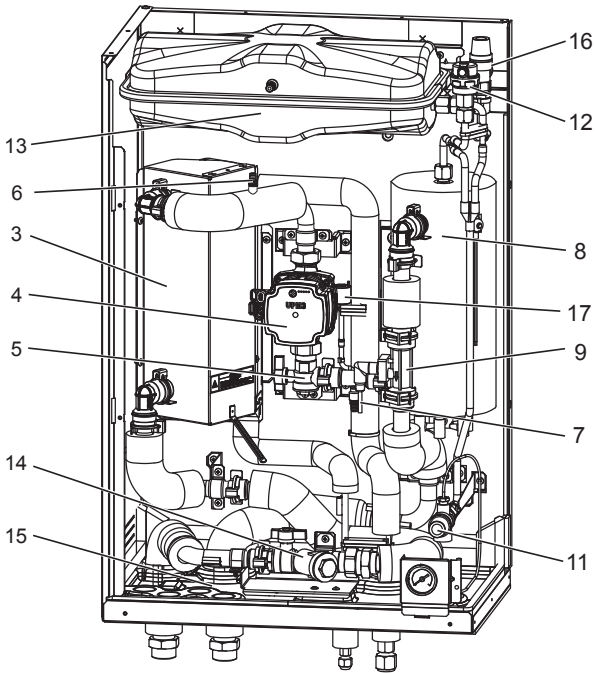

<Figure 4.3>

<E*SE-*M*ED> (Split model system)

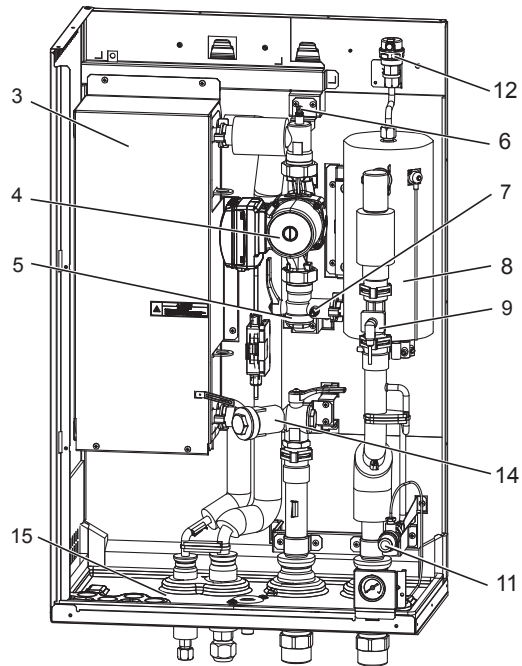

<Figure 4.4>

No.	Part name	EHPX-*M*(E)D	ERPX-MD	ERPX-*M*D	EHS*-MED	EHS*-*M*D	EHS*-YM9ED	ERS*-*M*(E)D	ERS*-MED
1	Control and electrical box	✓	✓	✓	✓	✓	✓	✓	✓
2	Main remote controller	✓	✓	✓	✓	✓	✓	✓	✓
3	Plate heat exchanger (Refrigerant - Water)	-	-	-	✓	✓	✓	✓	✓
4	Water circulation pump 1	✓	✓	✓	✓	✓	✓	✓	✓
5	Pump valve	✓	✓	✓	✓	✓	✓	✓	✓
6	Air vent (manual)	-	-	-	✓	✓	✓	✓	✓
7	Drain cock (Primary circuit)	✓	-	✓	✓	✓	✓	✓	✓
8	Booster heater 1,2	✓	-	✓	-	✓	✓	✓	-
9	Flow sensor	✓	✓	✓	✓	✓	✓	✓	✓
10	Manometer	✓	✓	✓	✓	✓	✓	✓	✓
11	Pressure relief valve (3 bar)	-	-	-	✓	✓	✓	✓	✓
12	Automatic air vent	✓	✓	✓	✓	✓	✓	✓	✓
13	Expansion vessel	✓*1	✓	✓	-	✓	-	✓*2	-
14	Strainer valve	✓	✓	✓	✓	✓	✓	✓	✓
15	Drain pan	-	✓	✓	-	-	-	✓	✓
16	Pressure relief valve (5 bar)	✓*1	-	✓	-	✓	-	✓*2	-
17	Pressure sensor	-	-	-	✓*3	✓*3	✓*3	✓*3	✓*3

<Table 4.1>

Note:
For installation of all E***-M*ED models, make sure to install a suitably sized primary-side expansion vessel. (See figure 8.1 and 8.2 for further guidance)

*1 EHPX-YM9ED and EHPX-MED are not included.
*2 ERSE-YM9ED is not included.
*3 Only 2HP (E*SD) model.

5

OUTLINES AND DIMENSIONS

5-1. Technical Drawings

<Unit: mm>

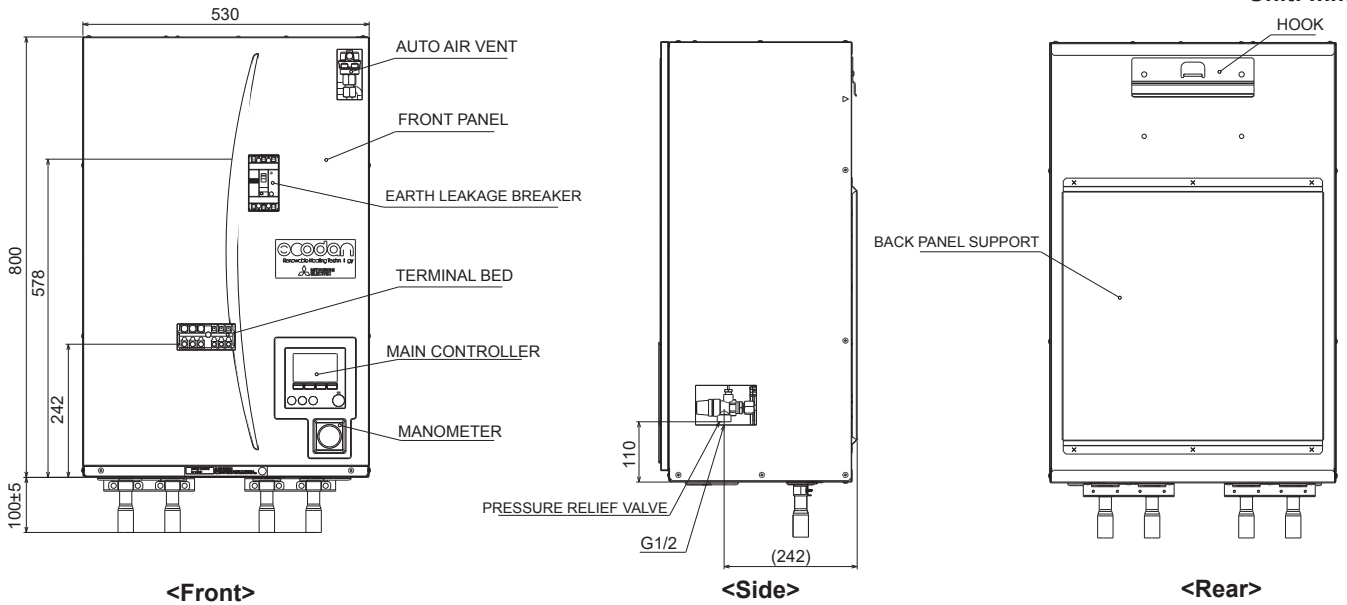

<EHPX> (Packaged model system for heating)

<ERPX> (Packaged model system for heating and cooling)

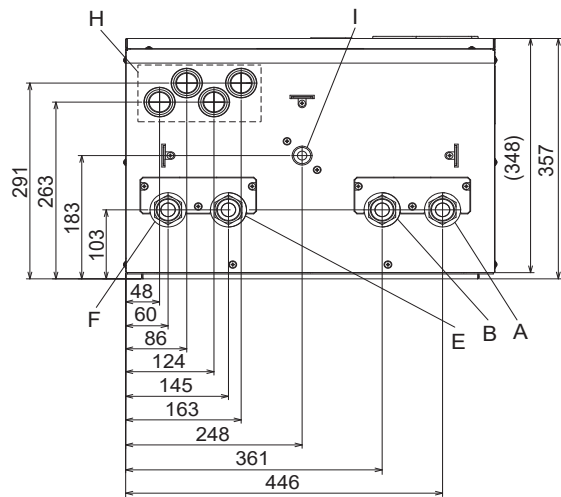
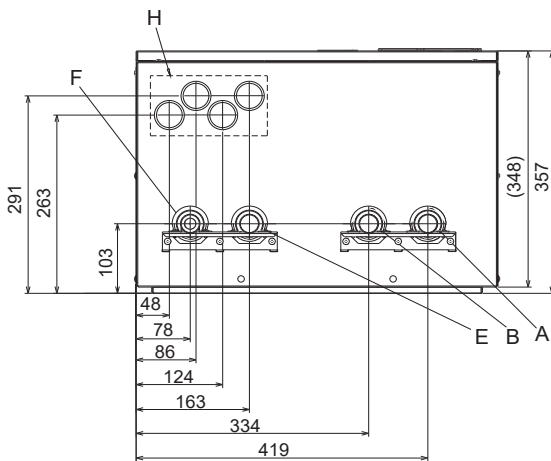

<View from below>

<View from below>

Letter	Pipe description	Connection size/type
A	Space heating/Indirect DHW tank (primary) RETURN connection	28mm/Compression (EHSD/EHSC/EHPX-*) G1 nut (ERSD/ERSC/ERPX-*) G1-1/2 nut (E*SE-*)
B	Space heating/Indirect DHW tank (primary) FLOW connection	28mm/Compression (EHSD/EHSC/EHPX-*) G1 nut (ERSD/ERSC/ERPX-*) G1-1/2 nut (E*SE-*)
C	Refrigerant (Liquid)	6.35 mm/Flare (E*SD-*) 9.52 mm/Flare (E*SC-*) 9.52 mm/Flare (E*SE-*)
D	Refrigerant (Gas)	12.7 mm/Flare (E*SD-*) 15.88 mm/Flare (E*SC-*) Brazing connection I.D. ø25.4 (E*SE-*)
E	Flow connection FROM heat pump	28 mm/Compression (EHPX-*) G1 nut (ERPX-*)
F	Return connection TO heat pump	28 mm/Compression (EHPX-*) G1 nut (ERPX-*)
G	Discharge pipe (by installer) from pressure relief valve	G1/2" female (valve port within hydrobox casing)
H	Electrical cable inlets ① ② ③ ④	For inlets ① and ②, run high-voltage wires including power cable, indoor-outdoor cable, and external output wires. For inlets ③ and ④, run low-voltage wires including external input wires and thermistor wires. For a wireless receiver (option) cable, use inlet ④.
I	Drain socket	O.D. ø20

<Table 5.1>

<Unit: mm>

<EHS*> (Split model system for heating)

<ERS*> (Split model system for heating and cooling)

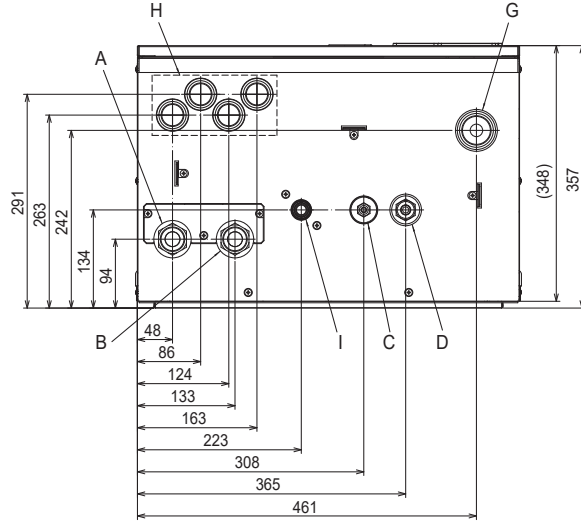
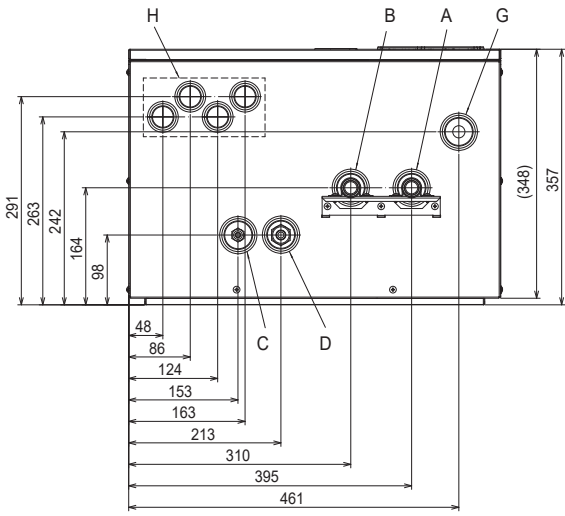

<View from below>

<View from below>

<E*SE> (Split model system for heating/ heating and cooling)

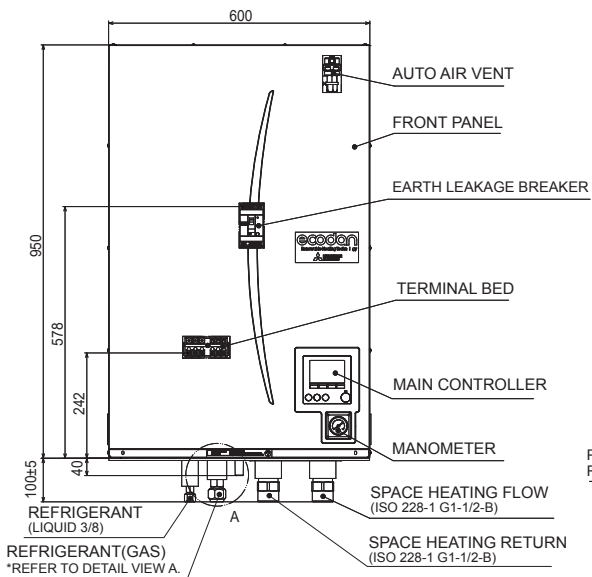

<Front>

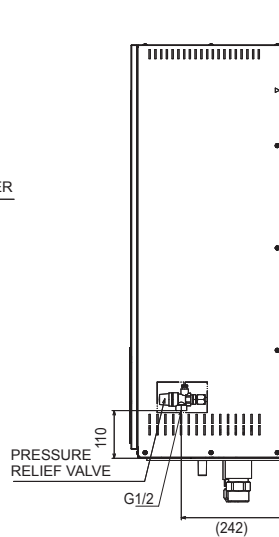

<Side>

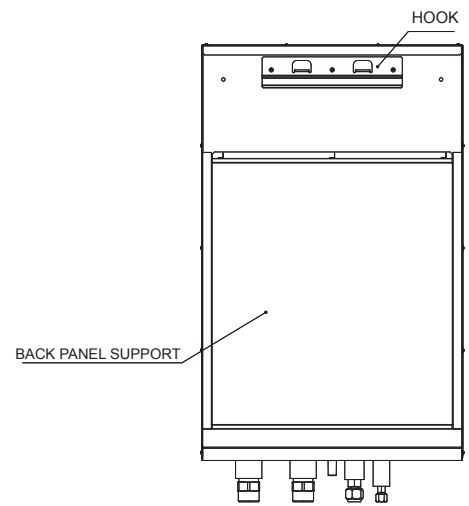

<Rear>

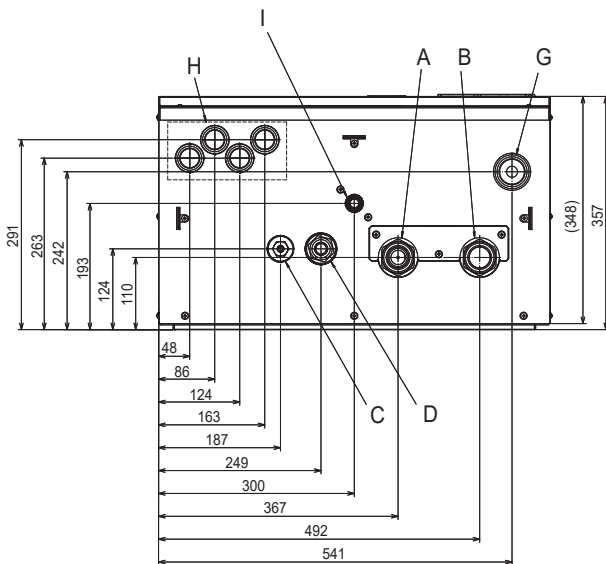

<View from below>

DEATIL VIEW A

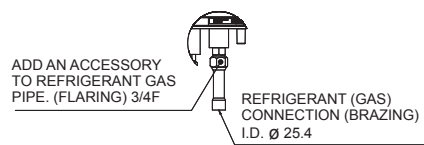

6-1. EHSD-MED.UK, ERSD-MED.UK, EHSC-MED.UK, ERSC-MED.UK, EHSE-MED.UK, ERSE-MED.UK, EHPX-MED.UK, ERPX-MD.UK

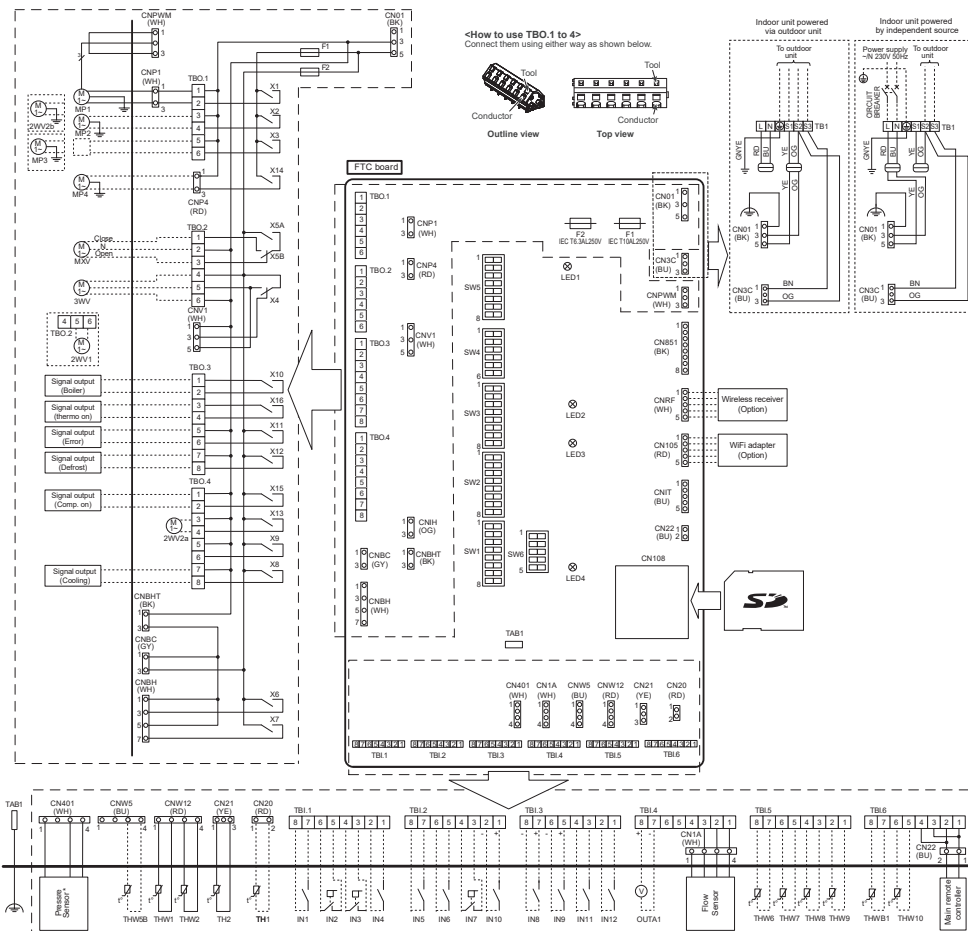

Table 1 Signal Inputs

Name	Terminal block	Connector	Item	OFF (Open)	ON (Short)
IN1	TBI.1 7-8	—	Room thermostat 1 input *1	Refer to SW2-1 in <Table 6.6.1 DIP Switch Functions>.	
IN2	TBI.1 5-6	—	Flow switch 1 input	Refer to SW2-2 in <Table 6.6.1 DIP Switch Functions>.	
IN3	TBI.1 3-4	—	Flow switch 2 input (Zone1)	Refer to SW3-2 in <Table 6.6.1 DIP Switch Functions>.	
IN4	TBI.1 1-2	—	Demand control input	Normal	Heat source OFF/Boiler operation *3
IN5	TBI.2 7-8	—	Outdoor thermostat input *2	Standard operation	Heater operation/Boiler operation *3
IN6	TBI.2 5-6	—	Room thermostat 2 input *1	Refer to SW3-1 in <Table 6.6.1 DIP Switch Functions>.	
IN7	TBI.2 3-4	—	Flow switch 3 input (Zone2)	Refer to SW3-2 in <Table 6.6.1 DIP Switch Functions>.	
IN8	TBI.3 7-8	—	Electric energy meter 1	Refer to installation manual.	
IN9	TBI.3 5-6	—	Electric energy meter 2		
IN10	TBI.2 1-2	—	Heat meter		
IN11	TBI.3 3-4	—	Smart grid ready input		
IN12	TBI.3 1-2	—	Smart grid ready input		
INA1	TBI.4 1-3	CN1A	Flow sensor		

- *1. Set the ON/OFF cycle time of the room thermostat for 10 minutes or more; otherwise the compressor may be damaged.
- *2. If using outdoor thermostat for controlling operation of heaters, the lifetime of the heaters and related parts may be reduced.
- *3. To turn on the boiler operation, use the main remote controller to select "Boiler" in "External input setting" screen in the service menu.

Table 2 Outputs

Name	Terminal block	Connector	Item	OFF	ON
OUT1	TBO.1 1-2	CNP1	Water circulation pump 1 output (Space heating/cooling & DHW)	OFF	ON
OUT2	TBO.1 3-4	—	Water circulation pump 2 output (Space heating/cooling for Zone1)	OFF	ON
OUT3	TBO.1 5-6	—	Water circulation pump 3 output (Space heating/cooling for Zone2) *1	OFF	ON
OUT4	TBO.2 4-6	CNV1	3-way valve (2-way valve) output		
		CN851	3-way valve output	Heating	DHW
OUT5	TBO.2 1-2	—	Mixing valve output *1	Stop	Close
OUT6	TBO.2 2-3	—	Booster heater 1 output	OFF	ON
OUT7	—	CN813	Booster heater 2 output	OFF	ON
OUT8	TBO.4 7-8	CNIH	Cooling signal output	OFF	ON
OUT9	TBO.4 5-6	CNIH	Immersion heater output	OFF	ON
OUT10	TBO.3 1-2	—	Boiler output	OFF	ON
OUT11	TBO.3 5-6	—	Error output	Normal	Error
OUT12	TBO.3 7-8	—	Defrost output	Normal	Defrost
OUT13	TBO.4 3-4	—	2-way valve 2a output *2	OFF	ON
OUT14	—	CNP4	Water circulation pump 4 output (DHW)	OFF	ON
OUT15	TBO.4 1-2	—	Comp. ON signal	OFF	ON
OUT16	TBO.3 3-4	—	Thermo ON signal	OFF	ON
OUTA1	TBI.4 7-8	—	Analog output	0V-10V	

Do not connect to the terminals that are indicated as "-" in the "Terminal block" field.
 *1. For 2-zone temperature control.
 *2. For 2-zone valve ON/OFF control.

Symbol	Name
TBI.1	Terminal block <Power supply, Outdoor unit>
ECB1	Earth leakage circuit breaker for booster heater
MP1	Water circulation pump 1 (Space heating and DHW)
MP2	Water circulation pump 2 (Space heating for Zone1) (Local supply)
MP3	Water circulation pump 3 (Space heating for Zone2) (Local supply)
MP4	Water circulation pump 4 (DHW) (Local supply)
3W/2W1	3-way valve (2-way valve) (Local supply)
2WV2a	2-way valve (For Zone 1) (Local supply)
2WV2b	2-way valve (For Zone 2) (Local supply)
MXV	Mixing valve (Local supply)
BHT	Thermostat for booster heater
BHF	Thermal fuse for booster heater
BH1	Booster heater 1
BH2	Booster heater 2
BHC1	Contact for booster heater 1
BHC2	Contact for booster heater 2
BHCP	Contact for booster heater protection
TH1	Thermistor (Room temp.) (Option)
TH2	Thermistor (Ref. liquid temp.)
THW1	Thermistor (Flow water temp.)
THW2	Thermistor (Return water temp.)
THW5B	Thermistor (DHW tank water temp.) (Option)
THW6	Thermistor (Zone1 flow temp.) (Option)
THW7	Thermistor (Zone1 return temp.) (Option)
THW8	Thermistor (Zone2 flow temp.) (Option)
THW9	Thermistor (Zone2 return temp.) (Option)
THW10	Thermistor (Mixing tank temp.) (Option)
THWB1	Thermistor (Boiler flow temp.) (Option)
IN1	Room thermostat 1 (Local supply)
IN2	Flow switch 1 (Local supply)
IN3	Flow switch 2 (Local supply)
IN4	Demand control (Local supply)
IN5	Outdoor thermostat (Local supply)
IN6	Room thermostat 2 (Local supply)
IN7	Flow switch 3 (Local supply)
IN8	Electric energy meter 1 (Local supply)
IN9	Electric energy meter 2 (Local supply)
IN10	Heat meter (Local supply)
IN11	Smart grid ready input (Local supply)
IN12	Flow sensor
INA1	Flow sensor
FLOW TEMP. CONTROLLER (FTC)	
TBO.1-4 Terminal block <Outputs>	
TBI.1-6	Terminal block <Signal Inputs, Thermostat>
F1	Fuse (IEC T10AL250V)
F2	Fuse (IEC T6.3AL250V)
SW1-6	DIP switch *See Table 6.6.1
X1-16	Relay
LED1	Power supply (FTC)
LED2	Power supply (Main remote controller)
LED3	Communication (FTC-Outdoor unit)
LED4	Reading or writing data to SD card
CNPWM	Pump speed control signal for MP1
CN108	SD card connector

6-2. EHSD-VM2D.UK, ERSD-VM2D.UK, EHSC-VM2D.UK, ERSC-VM2D.UK, EHPX-VM2D.UK, ERPX-VM2D.UK

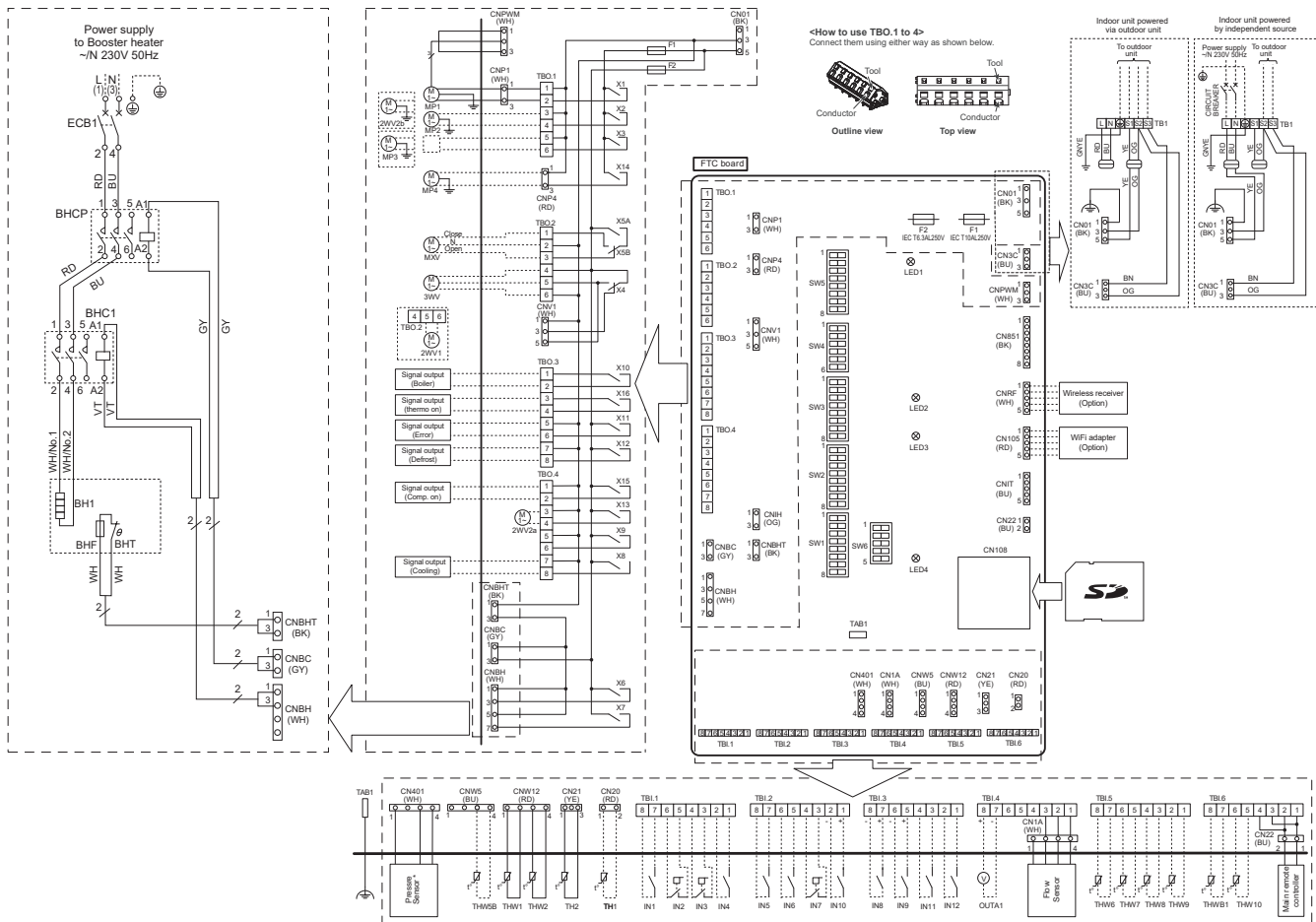

Table 1 Signal Inputs

Name	Terminal block	Connector	Item	OFF (Open)	ON (Short)
IN1	TB1.1 7-8	—	Room thermostat 1 input *1	Refer to SW2-1 in <Table 6.6.1 DIP Switch Functions>.	Refer to SW2-2 in <Table 6.6.1 DIP Switch Functions>.
IN2	TB1.1 5-6	—	Flow switch 1 input	Refer to SW3-1 in <Table 6.6.1 DIP Switch Functions>.	Refer to SW3-2 in <Table 6.6.1 DIP Switch Functions>.
IN3	TB1.1 3-4	—	Flow switch 2 input (Zone1)	Refer to SW3-3 in <Table 6.6.1 DIP Switch Functions>.	Refer to SW3-4 in <Table 6.6.1 DIP Switch Functions>.
IN4	TB1.1 1-2	—	Demand control input	Normal	Heater operation/Boiler operation *3
IN5	TB1.2 7-8	—	Outdoor thermostat input *2	Standard operation	Heater operation/Boiler operation *3
IN6	TB1.2 5-6	—	Room thermostat 2 input *1	Refer to SW3-1 in <Table 6.6.1 DIP Switch Functions>.	Refer to SW3-2 in <Table 6.6.1 DIP Switch Functions>.
IN7	TB1.2 3-4	—	Flow switch 3 input (Zone2)	Refer to SW3-3 in <Table 6.6.1 DIP Switch Functions>.	Refer to SW3-4 in <Table 6.6.1 DIP Switch Functions>.
IN8	TB1.3 7-8	—	Electric energy meter 1	Refer to installation manual.	
IN9	TB1.3 5-6	—	Electric energy meter 2		
IN10	TB1.2 1-2	—	Heat meter		
IN11	TB1.3 3-4	—	Smart grid ready input		
IN12	TB1.3 1-2	—	Smart grid ready input		
INA1	TB1.4 1-3	CN1A	Flow sensor		

1. Set the ON/OFF cycle time of the room thermostat for 10 minutes or more; otherwise the compressor may be damaged.
2. If using outdoor thermostat for controlling operation of heaters, the lifetime of the heaters and related parts may be reduced.
3. To turn on the boiler operation, use the main remote controller to select "Boiler" in "External input setting" screen in the service menu.

Table 2 Outputs

Name	Terminal block	Connector	Item	OFF	ON
OUT1	TBO.1 1-2	CNP1	Water circulation pump 1 output (Space heating/cooling & DHW)	OFF	ON
OUT2	TBO.1 3-4	—	Water circulation pump 2 output (Space heating/cooling for Zone1)	OFF	ON
OUT3	TBO.1 5-6	—	Water circulation pump 3 output (Space heating/cooling for Zone2) *1	OFF	ON
OUT4	TBO.2 4-6	CNV1	3-way valve (2-way valve) output	Heating	DHW
OUT5	TBO.2 1-2	CN85	3-way valve output	Stop	Close
OUT6	TBO.2 2-3	—	Mixing valve output *1	Stop	Open
OUT6	—	CN81-3	Booster heater 1 output	OFF	ON
OUT7	—	CN81-5	Booster heater 2 output	OFF	ON
OUT8	TBO.4 7-8	—	Cooling signal output	OFF	ON
OUT9	TBO.4 5-6	CNIH	Immersion heater output	OFF	ON
OUT10	TBO.3 1-2	—	Boiler output	OFF	ON
OUT11	TBO.3 5-6	—	Error output	Normal	Error
OUT12	TBO.3 7-8	—	Defrost output	Normal	Defrost
OUT13	TBO.4 3-4	—	2-way valve 2a output *2	OFF	ON
OUT14	—	CNP4	Water circulation pump 4 output (DHW)	OFF	ON
OUT15	TBO.4 1-2	—	Comp. ON signal	OFF	ON
OUT16	TBO.3 3-4	—	Thermo ON signal	OFF	ON
OUTA1	TB1.4 7-8	—	Analog output	0V-10V	

Do not connect to the terminals that are indicated as "—" in the "Terminal block" field.
 *1. For 2-zone temperature control.
 *2. For 2-zone valve CN/OFF control.

Symbol	Name
TB1	Terminal block «Power supply, Outdoor unit»
ECB1	Earth leakage circuit breaker for booster heater
MP1	Water circulation pump 1(Space heating and DHW)
MP2	Water circulation pump 2 (Space heating for Zone1)(Local supply)
MP3	Water circulation pump 3 (Space heating for Zone2)(Local supply)
MP4	Water circulation pump 4 (DHW)(Local supply)
3W1/2W1	3-way valve (2-way valve 1)(Local supply)
2W2a	2-way valve (For Zone 1)(Local supply)
2W2b	2-way valve (For Zone 2)(Local supply)
MXV	Mixing valve (Local supply)
BHT	Thermostat for booster heater
BHF	Thermal fuse for booster heater
BH1	Booster heater 1
BHC1	Contact for booster heater 1
BHCP	Contact for booster heater protection
TH1	Thermistor (Room temp.)(Option)
TH2	Thermistor (Ref. liquid temp.)
THW1	Thermistor (Flow water temp.)
THW2	Thermistor (Return water temp.)
THW5B	Thermistor (DHW tank water temp.)(Option)
THW6	Thermistor (Zone1 flow temp.)(Option)
THW7	Thermistor (Zone1 return temp.)(Option)
THW8	Thermistor (Zone2 flow temp.)(Option)
THW9	Thermistor (Zone2 return temp.)(Option)
THW10	Thermistor (Mixing tank temp.)(Option)
THWB1	Thermistor (Boiler flow temp.)(Option)
IN1	Room thermostat 1 (Local supply)
IN2	Flow switch 1 (Local supply)
IN3	Flow switch 2 (Local supply)
IN4	Demand control (Local supply)
IN5	Outdoor thermostat (Local supply)
IN6	Room thermostat 2 (Local supply)
IN7	Flow switch 3 (Local supply)
IN8	Electric energy meter 1 (Local supply)
IN9	Electric energy meter 2 (Local supply)
IN10	Heat meter (Local supply)
IN11	Smart grid ready input (Local supply)
IN12	Smart grid ready input (Local supply)
INA1	Flow sensor
FLOW TEMP. CONTROLLER (FTC)	
TBO.1-4	Terminal block «Outputs»
TB1.1-6	Terminal block «Signal Inputs, Thermistor»
F1	Fuse (IEC T10AL250V)
F2	Fuse (IEC T6.3AL250V)
SW1-6	DIP switch *See Table 6.6.1
X1-16	Relay
LED1	Power supply (FTC)
LED2	Power supply (Main remote controller)
LED3	Communication (FTC-Outdoor unit)
LED4	Reading or writing data to SD card
CNPWM	Pump speed control signal for MP1
CNI08	SD card connector

6-3. EHSD-VM6D.UK, ERSD-VM6D.UK, EHSC-VM6D.UK, ERSC-VM6D.UK, EHPX-VM6D.UK, ERPX-VM6D.UK

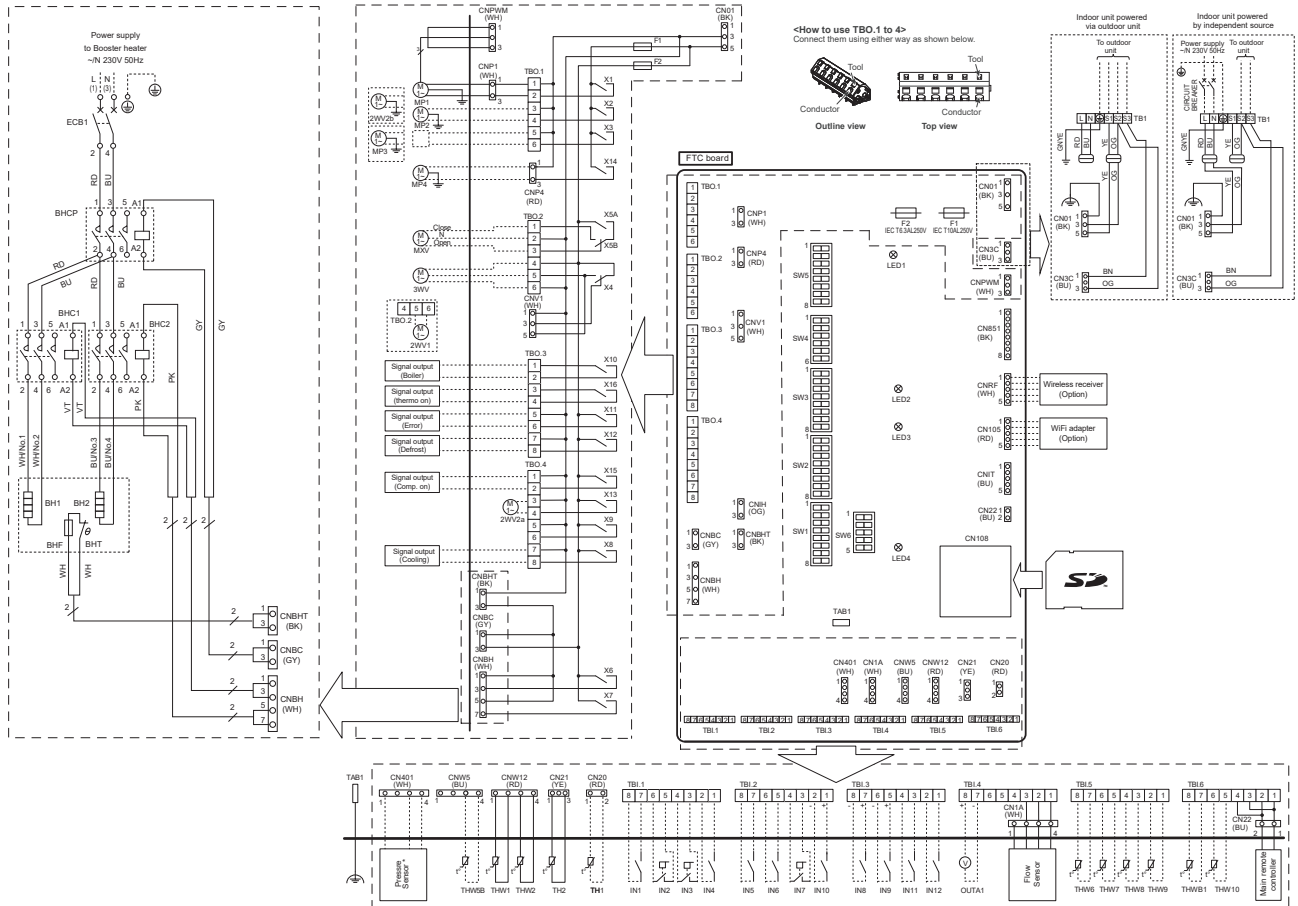

Table 1 Signal Inputs

Name	Terminal block	Connector	Item	OFF (Open)	ON (Short)
IN1	TB1.1 7-8	—	Room thermostat 1 input *1	Refer to SW2-1 in <Table 6.6.1 DIP Switch Functions>	
IN2	TB1.1 5-6	—	Flow switch 1 input	Refer to SW2-2 in <Table 6.6.1 DIP Switch Functions>	
IN3	TB1.1 3-4	—	Flow switch 2 input (Zone1)	Refer to SW3-2 in <Table 6.6.1 DIP Switch Functions>	
IN4	TB1.1 1-2	—	Demand control input	Normal	Heat source OFF/Boiler operation *3
IN5	TB1.2 7-8	—	Outdoor thermostat input *2	Standard operation	Heater operation/Boiler operation *3
IN6	TB1.2 5-6	—	Room thermostat 2 input *1	Refer to SW3-1 in <Table 6.6.1 DIP Switch Functions>	
IN7	TB1.2 3-4	—	Flow switch 3 input (Zone2)	Refer to SW3-2 in <Table 6.6.1 DIP Switch Functions>	
IN8	TB1.3 7-8	—	Electric energy meter 1		
IN9	TB1.3 5-6	—	Electric energy meter 2		
IN10	TB1.2 1-2	—	Heat meter		
IN11	TB1.3 3-4	—	Smart grid ready input	Refer to installation manual.	
IN12	TB1.3 1-2	—	Smart grid ready input		
INA1	TB1.4 1-3	CN1A	Flow sensor		

- *1. Set the ON/OFF cycle time of the room thermostat for 10 minutes or more; otherwise the compressor may be damaged.
- *2. If using outdoor thermostat for controlling operation of heaters, the lifetime of the heaters and related parts may be reduced.
- *3. To turn on the boiler operation, use the main remote controller to select 'Boiler' in 'External input setting' screen in the service menu.

Table 2 Outputs

Name	Terminal block	Connector	Item	OFF	ON
OUT1	TBO.1 1-2	CNP1	Water circulation pump 1 output (Space heating/cooling & DHW)	OFF	ON
OUT2	TBO.1 3-4	—	Water circulation pump 2 output (Space heating/cooling for Zone1)	OFF	ON
OUT3	TBO.1 5-6	—	Water circulation pump 3 output (Space heating/cooling for Zone2) *1	OFF	ON
OUT4	TBO.2 4-6	CNV1	3-way valve (2-way valve) output		
		CN851	3-way valve output		
OUT5	TBO.2 1-2	—	Mixing valve output *1	Stop	Close
	TBO.2 2-3	—	Mixing valve output *1	Open	
OUT6	—	CNBH13	Booster heater 1 output	OFF	ON
OUT7	—	CNBH5	Booster heater 2 output	OFF	ON
OUT8	TBO.4 7-8	—	Cooling signal output	OFF	ON
OUT9	TBO.4 5-6	CNIH	Immersion heater output	OFF	ON
OUT10	TBO.3 1-2	—	Boiler output	OFF	ON
OUT11	TBO.3 5-6	—	Error output	Normal	Error
OUT12	TBO.3 7-8	—	Defrost output	Normal	Defrost
OUT13	TBO.4 3-4	—	2-way valve 2a output *2	OFF	ON
OUT14	—	CNP4	Water circulation pump 4 output (DHW)	OFF	ON
OUT15	TBO.4 1-2	—	Comp. ON signal	OFF	ON
OUT16	TBO.3 3-4	—	Thermo ON signal	OFF	ON
OUTA1	TB1.4 7-8	—	Analog output	0V-10V	

Do not connect to the terminals that are indicated as "—" in the "Terminal block" field.
 *1. For 2-zone temperature control.
 *2. For 2-zone valve ON/OFF control.

Symbol	Name
TB1	Terminal block <Power supply, Outdoor unit>
ECB1	Earth leakage circuit breaker for booster heater
MP1	Water circulation pump 1(Space heating and DHW)
MP2	Water circulation pump 2 (Space heating for Zone1)(Local supply)
MP3	Water circulation pump 3 (Space heating for Zone2)(Local supply)
MP4	Water circulation pump 4 (DHW)(Local supply)
3W(2W)1	3-way valve (2-way valve 1)(Local supply)
2WV2a	2-way valve (For Zone 1)(Local supply)
2WV2b	2-way valve (For Zone 2)(Local supply)
MXV	Mixing valve (Local supply)
BHT	Thermostat for booster heater
BHF	Thermal fuse for booster heater
BH1	Booster heater 1
BH2	Booster heater 2
BHC1	Contact for booster heater 1
BHC2	Contact for booster heater 2
BHCP	Contact for booster heater protection
TH1	Thermistor (Room temp.)(Option)
TH2	Thermistor (Ref. liquid temp.)
THW1	Thermistor (Flow water temp.)
THW2	Thermistor (Return water temp.)
THW5B	Thermistor (DHW tank water temp.)(Option)
THW6	Thermistor (Zone1 flow temp.)(Option)
THW7	Thermistor (Zone1 return temp.)(Option)
THW8	Thermistor (Zone2 flow temp.)(Option)
THW9	Thermistor (Zone2 return temp.)(Option)
THW10	Thermistor (Mixing tank temp.)(Option)
THWB1	Thermistor (Boiler flow temp.)(Option)
IN1	Room thermostat 1 (Local supply)
IN2	Flow switch 1 (Local supply)
IN3	Flow switch 2 (Local supply)
IN4	Demand control (Local supply)
IN5	Outdoor thermostat (Local supply)
IN6	Room thermostat 2 (Local supply)
IN7	Flow switch 3 (Local supply)
IN8	Electric energy meter 1 (Local supply)
IN9	Electric energy meter 2 (Local supply)
IN10	Heat meter (Local supply)
IN11	Smart grid ready input (Local supply)
IN12	Smart grid ready input (Local supply)
INA1	Flow sensor
FLOW TEMP. CONTROLLER (FTC)	
TBO.1-4	Terminal block <Outputs>
TB1.1-6	Terminal block <Signal inputs, Thermistor>
F1	Fuse (EC T10AL250V)
F2	Fuse (EC T6.3AL250V)
SW1-6	DIP switch *See Table 6.6.1
X1-16	Relay
LED1	Power supply (FTC)
LED2	Power supply (Main remote controller)
LED3	Communication (FTC-Outdoor unit)
LED4	Reading or writing data to SD card
CNP4M	Pump speed control signal for MP1
CN108	SD card connector

6-4. EHSD-YM9D.UK, EHSD-YM9ED.UK, ERSD-YM9D.UK, EHSC-YM9D.UK, EHSC-YM9ED.UK, ERSC-YM9D.UK, EHSE-YM9ED.UK, ERSE-YM9ED.UK, EHPX-YM9D.UK, EHPX-YM9ED.UK, ERPX-YM9D.UK

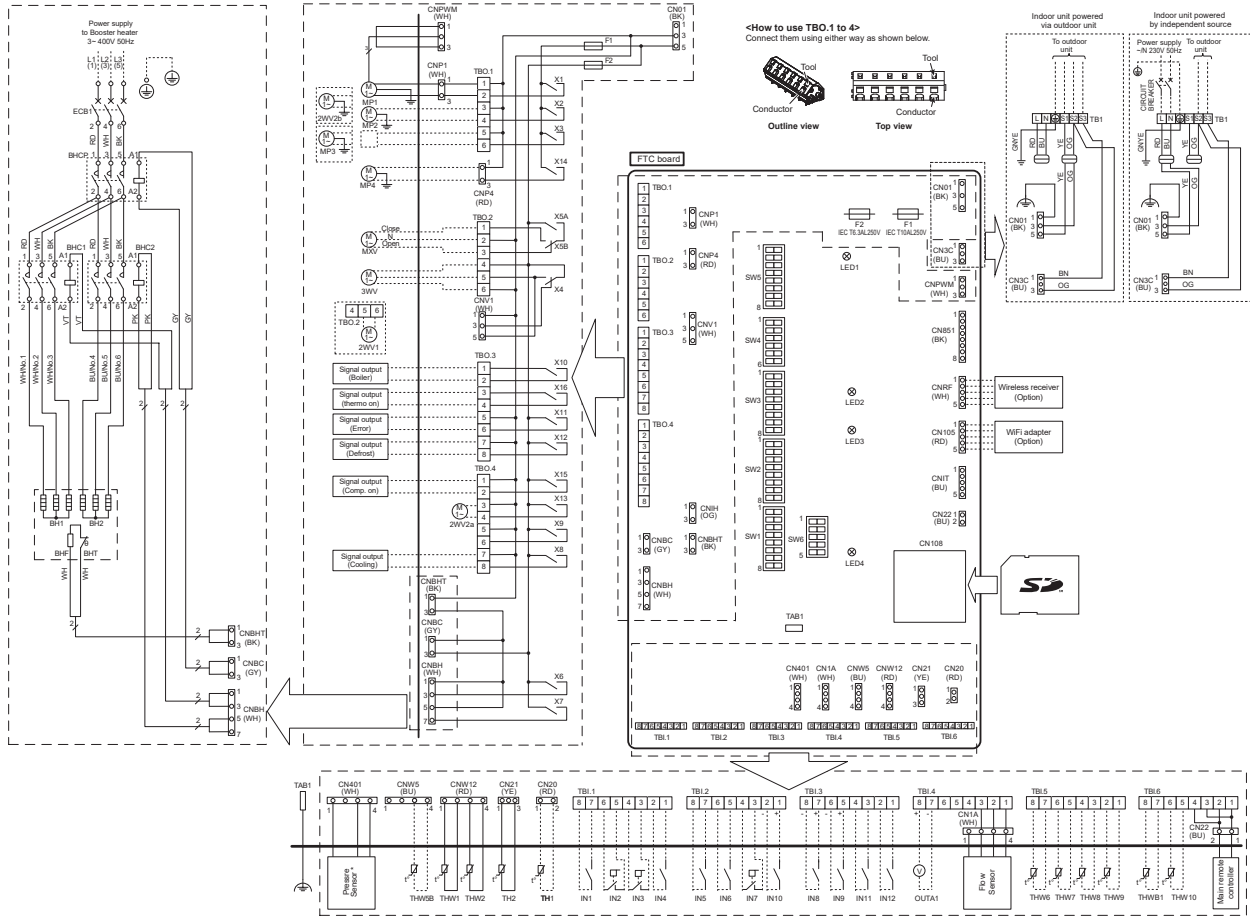

Table 1 Signal Inputs

Name	Terminal block	Connector	Item	OFF (Open)	ON (Short)
IN1	TBI.1 1-7-8	—	Room thermostat 1 input *1	Refer to SW2-1 in <Table 6.6.1 DIP Switch Functions>	
IN2	TBI.1 5-6	—	Flow switch 1 input	Refer to SW2-2 in <Table 6.6.1 DIP Switch Functions>	
IN3	TBI.1 3-4	—	Flow switch 2 input (Zone1)	Refer to SW3-2 in <Table 6.6.1 DIP Switch Functions>	
IN4	TBI.1 1-2	—	Demand control input	Normal	Heat source OFF/Boiler operation *3
IN5	TBI.2 7-8	—	Outdoor thermostat input *2	Standard operation	Heater operation/Boiler operation *3
IN6	TBI.2 5-6	—	Room thermostat 2 input *1	Refer to SW3-1 in <Table 6.6.1 DIP Switch Functions>	
IN7	TBI.2 3-4	—	Flow switch 3 input (Zone2)	Refer to SW3-2 in <Table 6.6.1 DIP Switch Functions>	
IN8	TBI.3 7-8	—	Electric energy meter 1		
IN9	TBI.3 5-6	—	Electric energy meter 2		
IN10	TBI.2 1-2	—	Heat meter		
IN11	TBI.3 3-4	—	Smart grid ready input	Refer to installation manual.	
INA1	TBI.4 1-3	CN1A	Flow sensor		

- *1. Set the ON/OFF cycle time of the room thermostat for 10 minutes or more; otherwise the compressor may be damaged.
- *2. If using outdoor thermostat for controlling operation of heaters, the lifetime of the heaters and related parts may be reduced.
- *3. To turn on the boiler operation, use the main remote controller to select "Boiler" in "External input setting" screen in the service menu.

Table 2 Outputs

Name	Terminal block	Connector	Item	OFF	ON
OUT1	TBO.1 1-2	CNP1	Water circulation pump 1 output (Space heating/cooling & DHW)	OFF	ON
OUT2	TBO.1 3-4	—	Water circulation pump 2 output (Space heating/cooling for Zone1)	OFF	ON
OUT3	TBO.1 5-6	—	Water circulation pump 3 output (Space heating/cooling for Zone2) *1	OFF	ON
OUT4	TBO.2 4-6	CNV1	3-way valve (2-way valve) output	Heating	DHW
		CN851	3-way valve output		
OUT5	TBO.2 1-2	—	Mixing valve output *1	Stop	Close
OUT6	TBO.2 2-3	—	Booster heater 1 output	Open	Open
OUT7	—	QBH13	Booster heater 2 output	OFF	ON
		QBH57	Booster heater 2 output	OFF	ON
OUT8	TBO.4 7-8	—	Cooling signal output	OFF	ON
OUT9	TBO.4 5-6	CNIH	Immersion heater output	OFF	ON
OUT10	TBO.3 1-2	—	Boiler output	OFF	ON
OUT11	TBO.3 5-6	—	Error output	Normal	Error
OUT12	TBO.3 7-8	—	Defrost output	Normal	Defrost
OUT13	TBO.4 3-4	—	2-way valve 2a output *2	OFF	ON
OUT14	—	CNP4	Water circulation pump 4 output (DHW)	OFF	ON
OUT15	TBO.4 1-2	—	Comp. ON signal	OFF	ON
OUT16	TBO.3 3-4	—	Thermo ON signal	OFF	ON
OUTA1	TBI.4 7-8	—	Analog output	0V-10V	

Do not connect to the terminals that are indicated as "—" in the "Terminal block" field.
 *1. For 2-zone temperature control.
 *2. For 2-zone valve ON/OFF control.

Symbol	Name
TBI	Terminal block <Power supply, Outdoor unit>
ECB1	Earth leakage circuit breaker for booster heater
MP1	Water circulation pump 1(Space heating and DHW)
MP2	Water circulation pump 2 (Space heating for Zone1)(Local supply)
MP3	Water circulation pump 3 (Space heating for Zone2)(Local supply)
MP4	Water circulation pump 4 (DHW)(Local supply)
2WV1(2WV1)	3-way valve (2-way valve 1)(Local supply)
2WV2a	2-way valve (For Zone 1)(Local supply)
2WV2b	2-way valve (For Zone 2)(Local supply)
MXV	Mixing valve (Local supply)
BHT	Thermostat for booster heater
BHF	Thermal fuse for booster heater
BH1	Booster heater 1
BH2	Booster heater 2
BHC1	Contactor for booster heater 1
BHC2	Contactor for booster heater 2
BHP	Contactor for booster heater protection
TH1	Thermistor (Room temp.)(Option)
TH2	Thermistor (Ref. liquid temp.)
THW1	Thermistor (Flow water temp.)
THW2	Thermistor (Return water temp.)
THW5B	Thermistor (DHW tank water temp.)(Option)
THW6	Thermistor (Zone1 flow temp.)(Option)
THW7	Thermistor (Zone1 return temp.)(Option)
THW8	Thermistor (Zone2 flow temp.)(Option)
THW9	Thermistor (Zone2 return temp.)(Option)
THW10	Thermistor (Mixing tank temp.)(Option)
THWB1	Thermistor (Boiler flow temp.)(Option)
IN1	Room thermostat 1 (Local supply)
IN2	Flow switch 1 (Local supply)
IN3	Flow switch 2 (Local supply)
IN4	Demand control (Local supply)
IN5	Outdoor thermostat (Local supply)
IN6	Room thermostat 2 (Local supply)
IN7	Flow switch 3 (Local supply)
IN8	Electric energy meter 1 (Local supply)
IN9	Electric energy meter 2 (Local supply)
IN10	Heat meter (Local supply)
IN11	Smart grid ready input (Local supply)
IN12	Smart grid ready input (Local supply)
INA1	Flow sensor
FLOW TEMP. CONTROLLER (FTC)	
TBO.1-4	Terminal block <Outputs>
TBI.1-6	Terminal block <Signal Inputs, Thermistor>
F1	Fuse (IEC T10AL250V)
F2	Fuse (IEC T6.3AL250V)
SW1-6	DIP switch *See Table 6.6.1
X1-16	Relay
LED1	Power supply (FTC)
LED2	Power supply (Main remote controller)
LED3	Communication (FTC-Outdoor unit)
LED4	Reading or writing data to SD card
CNPWM	Pump speed control signal for MP1
CN108	SD card connector

6-5. EHSD-TM9D.UK, EHSC-TM9D.UK

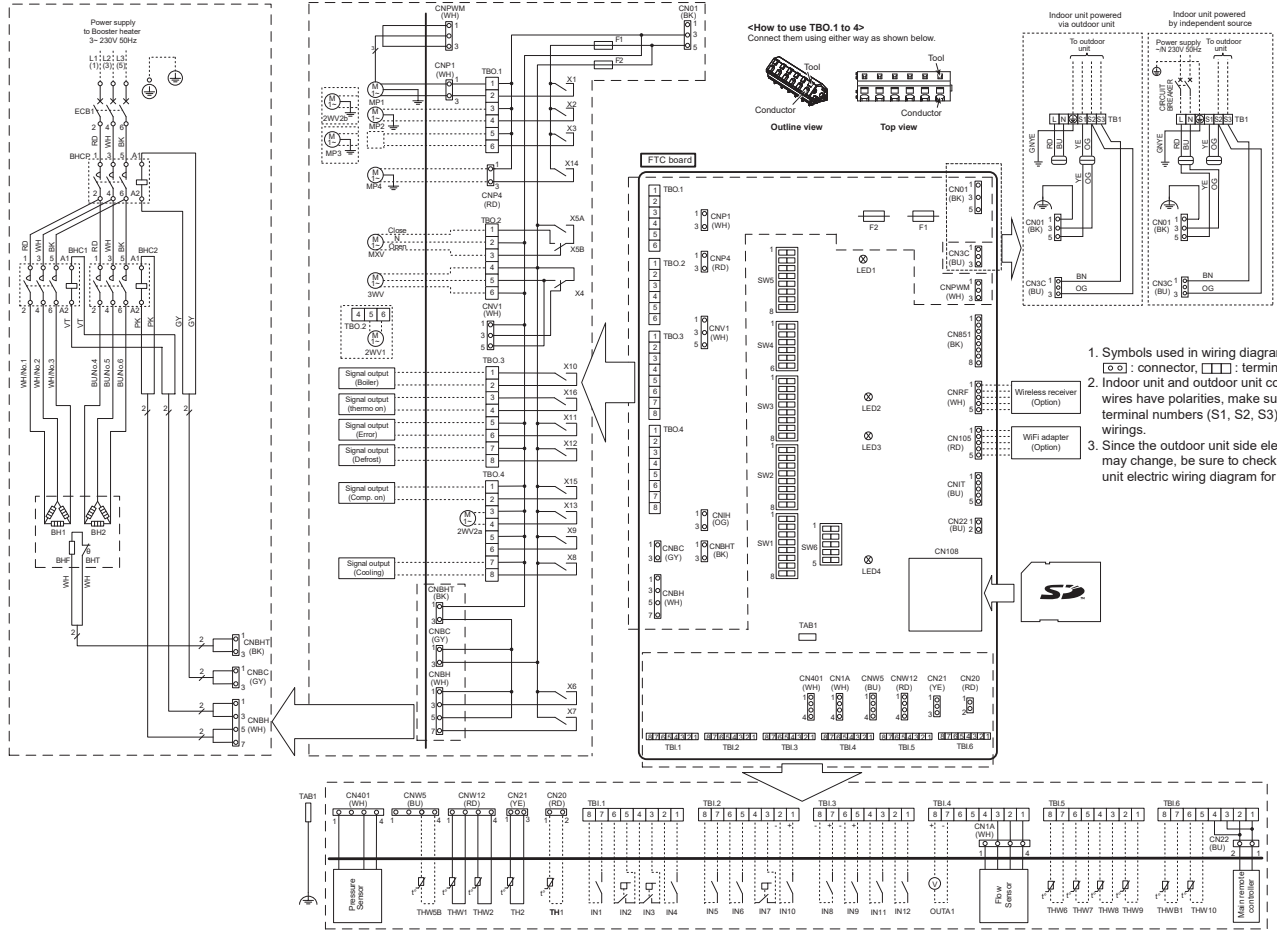

Table 1 Signal Inputs

Name	Terminal block	Connector	Item	OFF (Open)	ON (Short)
IN1	TBI.1 7-8	—	Room thermostat 1 input *1	Refer to SW2-1 in <Table 6.6.1 DIP Switch Functions>.	
IN2	TBI.1 5-6	—	Flow switch 1 input	Refer to SW2-2 in <Table 6.6.1 DIP Switch Functions>.	
IN3	TBI.1 3-4	—	Flow switch 2 input (Zone1)	Refer to SW2-2 in <Table 6.6.1 DIP Switch Functions>.	
IN4	TBI.1 1-2	—	Demand control input	Normal	Heat source OFF/Boiler operation *3
IN5	TBI.2 7-8	—	Outdoor thermostat input *2	Standard operation	Heater operation/Boiler operation *3
IN6	TBI.2 5-6	—	Room thermostat 2 input *1	Refer to SW3-1 in <Table 6.6.1 DIP Switch Functions>.	
IN7	TBI.2 3-4	—	Flow switch 3 input (Zone2)	Refer to SW3-2 in <Table 6.6.1 DIP Switch Functions>.	
IN8	TBI.3 7-8	—	Electric energy meter 1		
IN9	TBI.3 5-6	—	Electric energy meter 2		
IN10	TBI.2 1-2	—	Heat meter	Refer to installation manual.	
IN11	TBI.3 3-4	—	Smart grid ready input		
IN12	TBI.3 1-2	—	Smart grid ready input		
INA1	TBI.4 1-3	CN1A	Flow sensor		

1. Set the ON/OFF cycle time of the room thermostat for 10 minutes or more; otherwise the compressor may be damaged.
2. If using outdoor thermostat for controlling operation of heaters, the lifetime of the heaters and related parts may be reduced.
3. To turn on the boiler operation, use the main remote controller to select "Boiler" in "External input setting" screen in the service menu.

Table 2 Outputs

Name	Terminal block	Connector	Item	OFF	ON
OUT1	TBO.1 1-2	CNP1	Water circulation pump 1 output (Space heating/cooling & DHW)	OFF	ON
OUT2	TBO.1 3-4	—	Water circulation pump 2 output (Space heating/cooling for Zone1)	OFF	ON
OUT3	TBO.1 5-6	—	Water circulation pump 3 output (Space heating/cooling for Zone2) *1	OFF	ON
OUT4	TBO.2 4-6	CNV1	3-way valve (2-way valve) output	Heating	DHW
OUT5	TBO.2 1-2	CNB5	3-way valve output		
OUT6	TBO.2 2-3	—	Mixing valve output *1	Stop	Close
OUT7	—	CNB1 1-3	Booster heater 1 output	OFF	ON
OUT8	—	CNB1 5-7	Booster heater 2 output	OFF	ON
OUT9	TBO.4 7-8	—	Cooling signal output	OFF	ON
OUT10	TBO.4 5-6	CNIH	Immersion heater output	OFF	ON
OUT11	TBO.3 1-2	—	Boiler output	OFF	ON
OUT12	TBO.3 5-6	—	Error output	Normal	Error
OUT13	TBO.3 7-8	—	Defrost output	Normal	Defrost
OUT14	TBO.4 3-4	—	Water circulation pump 4 output (DHW)	OFF	ON
OUT15	TBO.4 1-2	—	Comp. ON signal	OFF	ON
OUT16	TBO.3 3-4	—	Thermo ON signal	OFF	ON
OUTA1	TBI.4 7-8	—	Analog output	0V-10V	

Do not connect to the terminals that are indicated as "—" in the "Terminal block" field.
 *1. For 2-zone temperature control.
 *2. For 2-zone valve ON/OFF control.

Symbol	Name
TB1	Terminal block <Power supply, Outdoor unit>
ECB1	Earth leakage circuit breaker for booster heater
MP1	Water circulation pump 1(Space heating & DHW)
MP2	Water circulation pump 2 (Space heating for Zone1)(Local supply)
MP3	Water circulation pump 3 (Space heating for Zone2)(Local supply)
MP4	Water circulation pump 4 (DHW)(Local supply)
3W1/2W1	3-way valve (2-way valve 1)(Local supply)
2W2a	2-way valve (For Zone 1)(Local supply)
2W2b	2-way valve (For Zone 2)(Local supply)
MXV	Mixing valve (Local supply)
BHT	Thermostat for booster heater
BHF	Thermal fuse for booster heater
BH1	Booster heater 1
BH2	Booster heater 2
BHC1	Contact for booster heater 1
BHC2	Contact for booster heater 2
BHCP	Contact for booster heater protection
TH1	Thermistor (Room temp.)(Option)
TH2	Thermistor (Ref. liquid temp.)
THW1	Thermistor (Flow water temp.)
THW2	Thermistor (Return water temp.)
THW5B	Thermistor (DHW tank water temp.)(Option)
THW6	Thermistor (Zone1 flow temp.)(Option)
THW7	Thermistor (Zone1 return temp.)(Option)
THW8	Thermistor (Zone2 flow temp.)(Option)
THW9	Thermistor (Zone2 return temp.)(Option)
THW10	Thermistor (Mixing tank temp.)(Option)
THWB1	Thermistor (Boiler flow temp.)(Option)
IN1	Room thermostat 1 (Local supply)
IN2	Flow switch 1 (Local supply)
IN3	Flow switch 2 (Local supply)
IN4	Demand control (Local supply)
IN5	Outdoor thermostat (Local supply)
IN6	Room thermostat 2 (Local supply)
IN7	Flow switch 3 (Local supply)
IN8	Electric energy meter 1 (Local supply)
IN9	Electric energy meter 2 (Local supply)
IN10	Heat meter (Local supply)
IN11	Smart grid ready input (Local supply)
IN12	Smart grid ready input (Local supply)
INA1	Flow sensor
FLOW TEMP. CONTROLLER (FTC)	
TBO.1-4	Terminal block <Outputs>
TBI.1-6	Terminal block <Signal Inputs, Thermistor>
F1	Fuse (IEC T10AL250V)
F2	Fuse (IEC T6.3AL250V)
SW1-6	DIP switch *See Table 6.6.1
X1-16	Relay
LED1	Power supply (FTC)
LED2	Power supply (Main remote controller)
LED3	Communication (FTC-Outdoor unit)
LED4	Reading or writing data to SD card
CNPWM	Pump speed control signal for MP1
CN108	SD card connector

6-6. DIP Switch Functions

The DIP switch number is printed on the circuit board next to the relevant switches. The word ON is printed on the circuit board and on the DIP switch block itself. To move the switch you need to use a pin or the corner of a thin metal ruler or similar.

DIP switch settings are listed below in Table 6.6.1.

Only an authorised installer can change DIP switch setting under one's own responsibility according to the installation condition.

Make sure to turn off both indoor unit and outdoor unit power supplies before changing the switch settings.

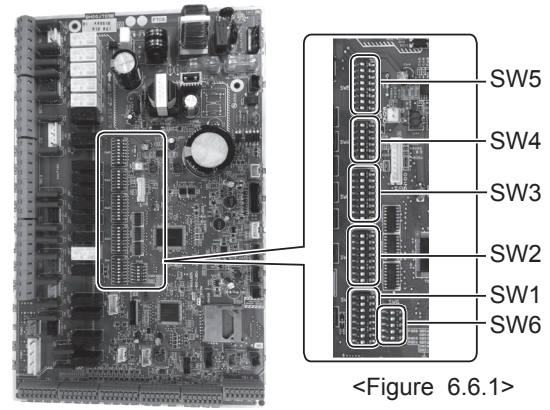

<Figure 6.6.1>

DIP switch	Function	OFF	ON	Default settings: Indoor model name			
SW1	SW1-1 Boiler	WITHOUT Boiler	WITH Boiler	OFF			
	SW1-2 Heat pump maximum outlet water temperature	55°C	60°C	OFF *1			
	SW1-3 DHW tank	WITHOUT DHW tank	WITH DHW tank	OFF			
	SW1-4 Immersion heater	WITHOUT Immersion heater	WITH Immersion heater	OFF			
	SW1-5 Booster heater	WITHOUT Booster heater	WITH Booster heater	OFF: E***-M*D ON : E***-M2/6/9*D			
	SW1-6 Booster heater function	For heating only	For heating and DHW	OFF: E***-M*D ON : E***-M2/6/9*D			
	SW1-7 Outdoor unit type	Split type	Packaged type	OFF: Except E*PX-*M**D ON : E*PX-*M**D			
	SW1-8 Wireless remote controller	WITHOUT Wireless remote controller	WITH Wireless remote controller	OFF			
SW2	SW2-1 Room thermostat1 input (IN1) logic change	Zone1 operation stop at thermostat short	Zone1 operation stop at thermostat open	OFF			
	SW2-2 Flow switch1 input (IN2) logic change	Failure detection at short	Failure detection at open	OFF			
	SW2-3 Booster heater capacity restriction	Inactive	Active	OFF: Except E***-VM2*D ON : E***-VM2*D			
	SW2-4 Cooling mode function	Inactive	Active	OFF: Except ER**-*M**D ON : ER**-*M**D			
	SW2-5 Automatic switch to backup heat source operation (When outdoor unit stops by error)	Inactive	Active *2	OFF			
	SW2-6 Mixing tank	WITHOUT Mixing tank	WITH Mixing tank	OFF			
	SW2-7 2-zone temperature control	Inactive	Active *3	OFF			
	SW2-8 Flow sensor	WITHOUT Flow sensor	WITH Flow sensor	ON			
SW3	SW3-1 Room thermostat 2 input logic change	Zone2 operation stop at thermostat short	Zone2 operation stop at thermostat open	OFF			
	SW3-2 Flow switch 2 and 3 input logic change	Failure detection at short	Failure detection at open	OFF			
	SW3-3	—	—	OFF			
	SW3-4 Electric energy meter	WITHOUT Electric energy meter	WITH Electric energy meter	OFF			
	SW3-5 Heating mode function *4	Inactive	Active	ON			
	SW3-6 2-zone valve ON/OFF control	Inactive	Active	OFF			
	SW3-7 Heat exchanger for DHW	Coil in tank	External plate HEX	OFF			
	SW3-8 Heat meter	WITHOUT Heat meter	WITH Heat meter	OFF			
SW4	SW4-1 Multiple outdoor units control	Inactive	Active	OFF			
	SW4-2 Position of multiple outdoor units control *5	Sub	Main	OFF			
	SW4-3	—	—	OFF			
	SW4-4 Indoor unit only operation (during installation work) *6	Inactive	Active	OFF			
	SW4-5 Emergency mode (Heater only operation)	Normal	Emergency mode (Heater only operation)	OFF *7			
	SW4-6 Emergency mode (Boiler operation)	Normal	Emergency mode (Boiler operation)	OFF *7			
SW5	SW5-1 DHW tank water temperature over heat protection (L4)	Active	Inactive *8	OFF			
	SW5-2 Advanced auto adaptation	Inactive	Active	ON			
	SW5-3	Capacity code					
	SW5-4		SW5-3	SW5-4	SW5-5	SW5-6	SW5-7
	SW5-5	E*SC-*M**D	ON	ON	ON	ON	OFF
	SW5-6	E*SD-*M**D	ON	OFF	OFF	ON	OFF
	SW5-7	E*SE-*M*ED	OFF	ON	ON	OFF	ON
	SW5-8	E*PX-*M**D	OFF	OFF	OFF	OFF	OFF
SW6	SW6-1	—	—	OFF			
	SW6-2	—	—	OFF			
	SW6-3 Pressure sensor	Inactive	Active	OFF: Except E*SD-*M**D ON : E*SD-*M**D			
	SW6-4 Analog output signal (0 to 10V)	Inactive	Active	OFF			
	SW6-5	—	—	OFF			

<Table 6.6.1>

- Notes:**
- *1. When the hydrobox is connected with a PUMY-P outdoor unit of which maximum outlet water temperature is 55°C, DIP SW1-2 must be changed to OFF.
 - *2. OUT11 will be available. For safety reasons, this function is not available for certain errors. (In that case, system operation must be stopped and only the water circulation pump keeps running.)
 - *3. Active only when SW3-6 is set to OFF.
 - *4. This switch functions only when the hydrobox is connected with a PUHZ-FRP outdoor unit. When another type of outdoor unit is connected, the heating mode function is active regardless of the fact that this switch is ON or OFF.
 - *5. Active only when SW4-1 is set to ON.
 - *6. Space heating and DHW can be operated only in indoor unit, like an electric heater. (Refer to "Indoor unit only operation" in page 42.)
 - *7. If emergency mode is no longer required, return the switch to OFF position.
 - *8. Please make sure to have necessary overheat protection on locally supplied solar thermal system side to secure safety, as the tank temperature could be much higher (than current).

Option1: Hydrobox powered via outdoor unit

<1 phase>

Affix label A that is included with the manuals near each wiring diagram for hydrobox and outdoor units.

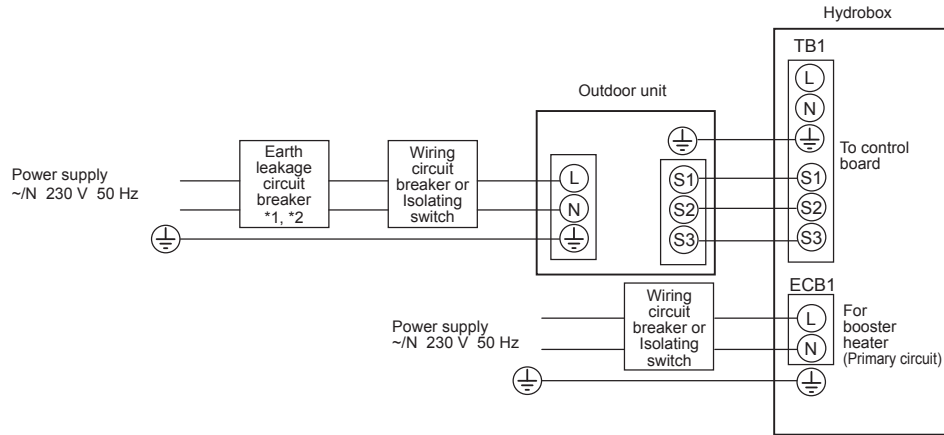

<Figure 7.1>
Electrical connections 1 phase

Description	Power supply	Capacity	Breaker	Wiring
Booster heater (Primary circuit)	~N 230 V 50 Hz	2 kW	16 A *2	2.5 mm ²
		6 kW	32 A *2	6.0 mm ²

<3 phase>

Affix label A that is included with the manuals near each wiring diagram for hydrobox and outdoor units.

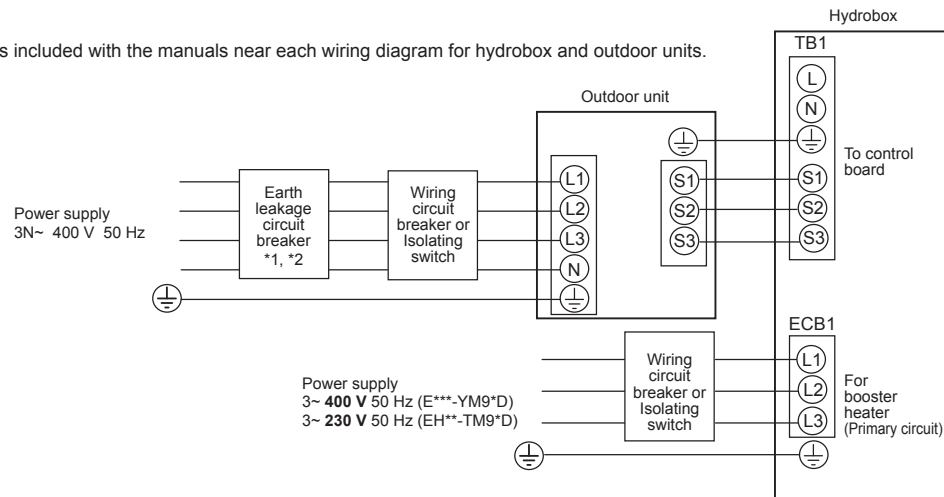

<Figure 7.2>
Electrical connections 3 phase

Description	Power supply	Capacity	Breaker	Wiring
Booster heater (Primary circuit)	3~ 400 V 50 Hz	9 kW	16 A *2	2.5 mm ²
	3~ 230 V 50 Hz	9 kW	32 A *2	6.0 mm ²

Wiring No. × size (mm ²)	Hydrobox - Outdoor unit	*3	3 × 1.5 (polar)
	Hydrobox - Outdoor unit earth	*3	1 × Min. 1.5
Circuit rating	Hydrobox - Outdoor unit S1 - S2	*4	230 VAC
	Hydrobox - Outdoor unit S2 - S3	*4	24 VDC

- *1. If the installed earth leakage circuit breaker does not have an over-current protection function, install a breaker with that function along the same power line.
- *2. A breaker with at least 3.0 mm contact separation in each pole shall be provided. Use earth leakage breaker (NV).
The breaker shall be provided to ensure disconnection of all active phase conductors of the supply.
- *3. Max. 45 m
If 2.5 mm² used, Max. 50 m
If 2.5 mm² used and S3 separated, Max. 80 m
- *4. The values given in the table above are not always measured against the ground value.

- Notes:**
1. Wiring size must comply with the applicable local and national codes.
 2. Indoor unit/outdoor unit connecting cords shall not be lighter than polychloroprene sheathed flexible cord. (Design 60245 IEC 57)
Indoor unit power supply cords shall not be lighter than polychloroprene sheathed flexible cord. (Design 60227 IEC 53)
 3. Install an earth line longer than power cables.
 4. Please keep enough output capacity of power supply for each heater. Insufficient power supply capacity might cause chattering.

Option2: Hydrobox powered by independent source

<1 phase>

Affix label B that is included with the manuals near each wiring diagram for hydrobox and outdoor units.

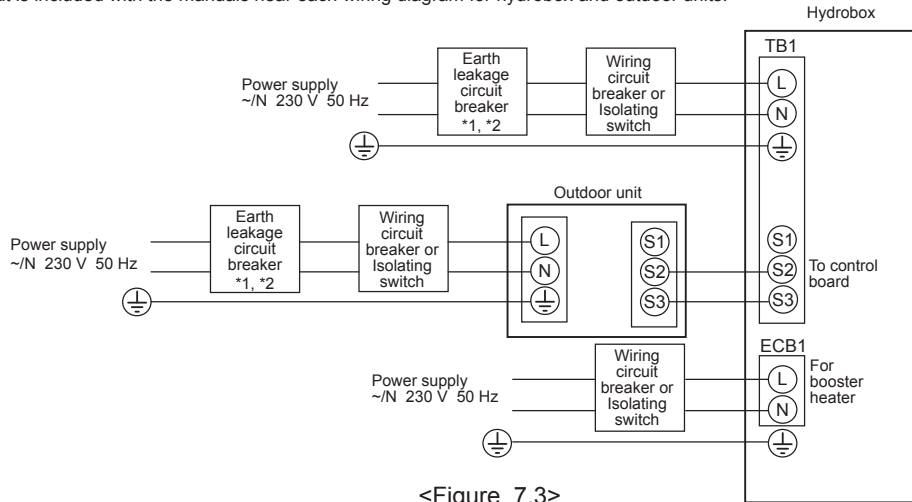

<Figure 7.3>
Electrical connections 1 phase

Description	Power supply	Capacity	Breaker	Wiring
Booster heater	~N 230 V 50 Hz	2 kW	16 A *2	2.5 mm ²
		6 kW	32 A *2	6.0 mm ²

<3 phase>

Affix label B that is included with the manuals near each wiring diagram for hydrobox and outdoor units.

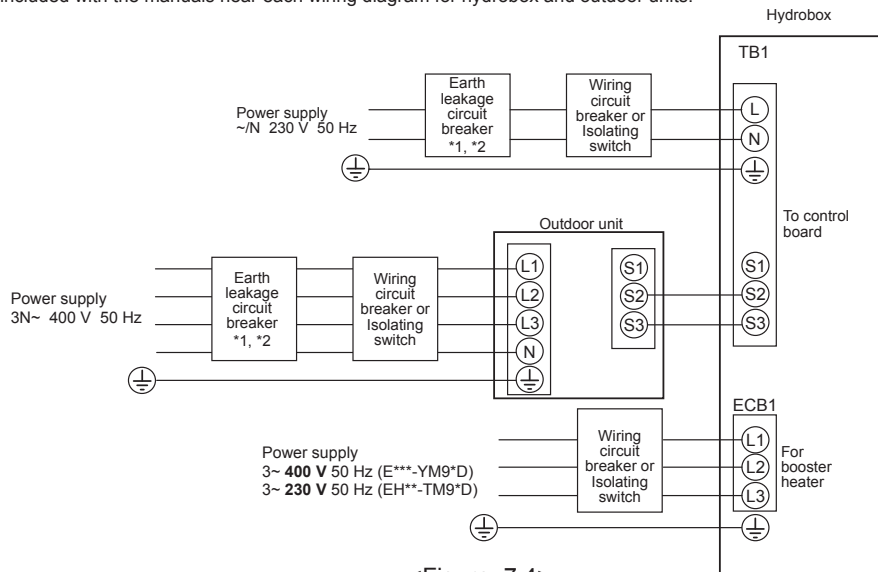

<Figure 7.4>
Electrical connections 3 phase

Description	Power supply	Capacity	Breaker	Wiring
Booster heater (Primary circuit)	3~ 400 V 50 Hz	9 kW	16 A *2	2.5 mm ²
	3~ 230 V 50 Hz	9 kW	32 A *2	6.0 mm ²

Hydrobox power supply		~N 230 V 50 Hz
Hydrobox input capacity		
Main switch (Breaker)		*2 16 A
Wiring No. x size (mm ²)	Hydrobox power supply	2 x Min. 1.5
	Hydrobox power supply earth	1 x Min. 1.5
	Hydrobox - Outdoor unit	*3 2 x Min. 0.3
Hydrobox - Outdoor unit earth		—
Circuit rating	Hydrobox L - N	*4 230 VAC
	Hydrobox - Outdoor unit S1 - S2	*4 —
	Hydrobox - Outdoor unit S2 - S3	*4 24 VDC

- *1. If the installed earth leakage circuit breaker does not have an over-current protection function, install a breaker with that function along the same power line.
- *2. A breaker with at least 3.0 mm contact separation in each pole shall be provided. Use earth leakage breaker (NV). The breaker shall be provided to ensure disconnection of all active phase conductors of the supply.
- *3. Max. 120 m
- *4. The values given in the table above are not always measured against the ground value.

- Notes:
1. Wiring size must comply with the applicable local and national codes.
 2. Indoor unit/outdoor unit connecting cords shall not be lighter than polychloroprene sheathed flexible cord. (Design 60245 IEC 57)
Indoor unit power supply cords shall not be lighter than polychloroprene sheathed flexible cord. (Design 60227 IEC 53)
 3. Install an earth line longer than power cables.
 4. Please keep enough output capacity of power supply for each heater. Insufficient power supply capacity might cause chattering.

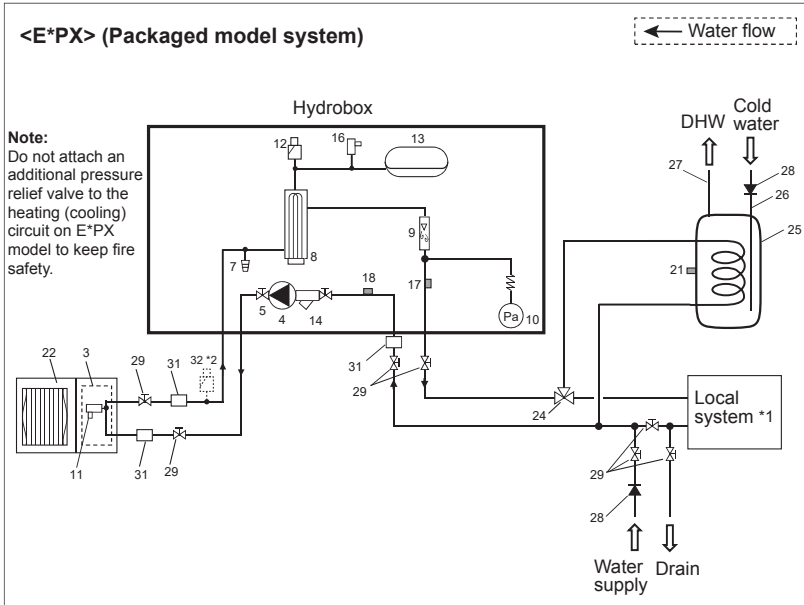

<Figure 8.1>

Note

- Be sure to follow your local regulations to perform system configuration of the DHW connections.
- DHW connections are not included in the hydrobox package. All required parts are to be sourced locally.
- To enable draining of the hydrobox an isolating valve should be positioned on both the inlet and outlet pipework.
- Be sure to install a strainer on the inlet pipe work to the hydrobox.
- Suitable drain pipework should be attached to the relief valves instructed to be connected to it in Figure 8.1 and 8.2 in accordance with your country's regulations.
- A backflow prevention device must be installed on water supply pipework (IEC 61770).
- When using components made from different metals or connecting pipes made of different metals insulate the joints to prevent a corrosive reaction taking place which will damage the pipework.

No.	Part name	EHPX-IM(E)D	ERPXM-D	ERPXM-D	EHS-MED	EHS-M'D	EHS-YM9ED	ERS-M'(E)D	ERS-MED
1	Control and electrical box	✓	✓	✓	✓	✓	✓	✓	✓
2	Main remote controller	✓	✓	✓	✓	✓	✓	✓	✓
3	Plate heat exchanger (Refrigerant - Water)	-	-	-	✓	✓	✓	✓	✓
4	Water circulation pump 1	✓	✓	✓	✓	✓	✓	✓	✓
5	Pump valve	✓	✓	✓	✓	✓	✓	✓	✓
6	Air vent (manual)	-	-	-	✓	✓	✓	✓	✓
7	Drain cock (Primary circuit)	✓	-	✓	✓	✓	✓	✓	✓
8	Booster heater 1, 2	✓	-	✓	-	✓	✓	✓	-
9	Flow sensor	✓	✓	✓	✓	✓	✓	✓	✓
10	Manometer	✓	✓	✓	✓	✓	✓	✓	✓
11	Pressure relief valve (3 bar)	-	-	-	✓	✓	✓	✓	✓
12	Automatic air vent	✓	✓	✓	✓	✓	✓	✓	✓
13	Expansion vessel	✓ ^{*3}	✓	✓	-	✓	-	✓ ^{*4}	-
14	Strainer valve	✓	✓	✓	✓	✓	✓	✓	✓
15	Drain pan	-	✓	✓	-	-	-	-	✓
16	Pressure relief valve (5 bar)	✓ ^{*3}	✓	✓	-	✓	-	✓ ^{*4}	-
17	THW1	✓	✓	✓	✓	✓	✓	✓	✓
18	THW2	✓	✓	✓	✓	✓	✓	✓	✓
19	TH2	-	-	-	✓	✓	✓	✓	✓
20	Pressure sensor	-	-	-	✓ ^{*5}	✓ ^{*5}	✓ ^{*5}	✓ ^{*5}	✓ ^{*5}
21	THW5B (Optional part PAC-TH011TK2-E or PAC-TH011TKL2-E)	-	-	-	-	-	-	-	-
22	Outdoor unit	-	-	-	-	-	-	-	-
23	Drain pipe (Local supply)	-	-	-	-	-	-	-	-
24	3-way valve (Local supply)	-	-	-	-	-	-	-	-
25	DHW indirect unvented tank (Local supply)	-	-	-	-	-	-	-	-
26	Cold water inlet pipe (Local supply)	-	-	-	-	-	-	-	-
27	DHW outlet pipe (Local supply)	-	-	-	-	-	-	-	-
28	Back flow prevention device (Local supply)	-	-	-	-	-	-	-	-
29	Isolating valve (Local supply)	-	-	-	-	-	-	-	-
30	Magnetic filter (Local supply) (Recommended)	-	-	-	-	-	-	-	-
31	Strainer (Local supply)	-	-	-	-	-	-	-	-
32	Air vent (Local supply)	-	-	-	-	-	-	-	-

<Table 8.1>

- *1 Refer to the following section [Local system].
- *2 If the outdoor unit is higher than the indoor unit, or if there is a location where air gets trapped in the upper part of the water pipe, consider adding this part.
- *3 EHPX-YM9ED and EHPX-MED are not included.
- *4 ERSE-YM9ED is not included.
- *5 Only 2HP(E*SD) model.

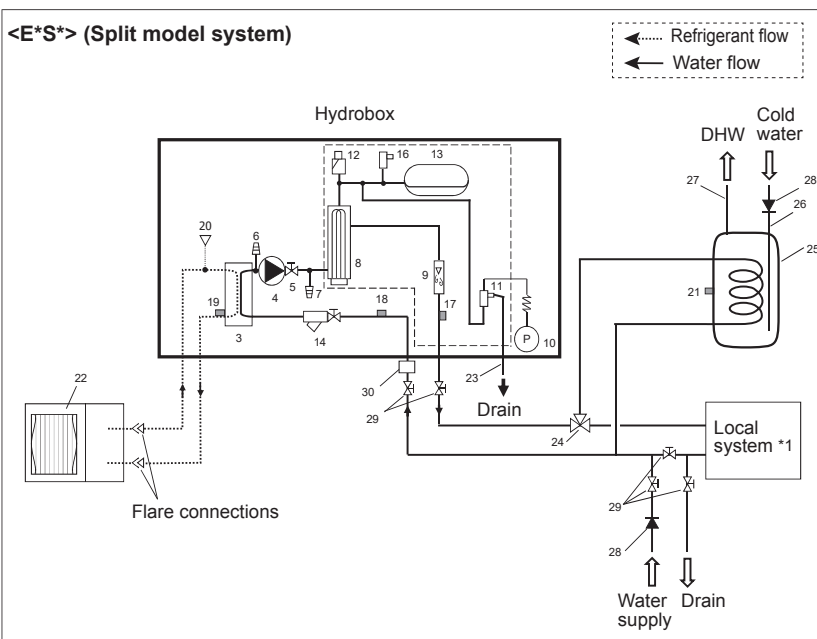

<Figure 8.2>

<E*SE only>

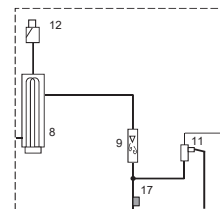

Local system

1-zone temperature control

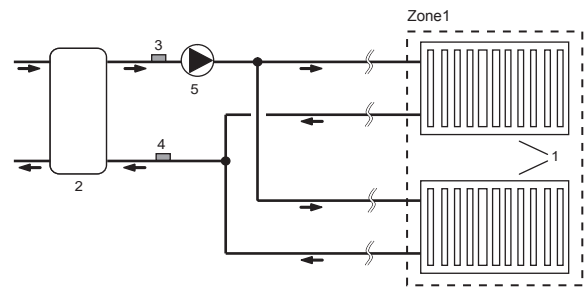
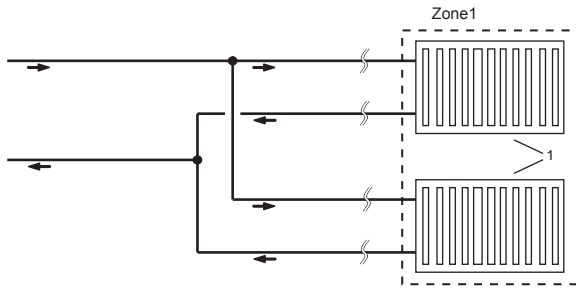

2-zone temperature control

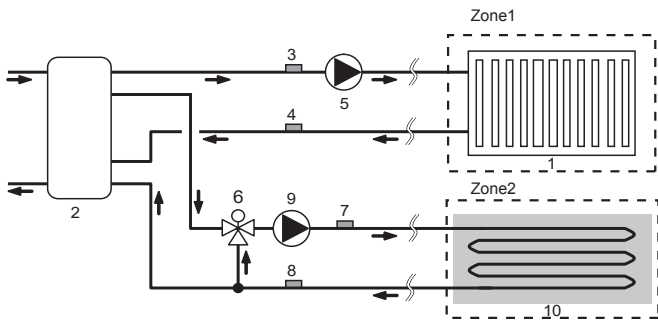

1-zone temperature control with boiler

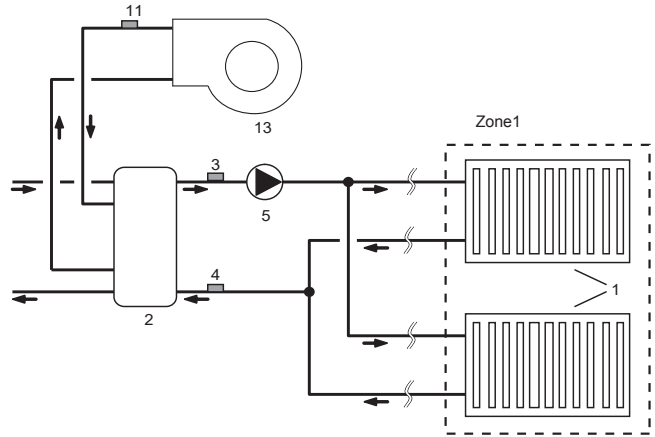

2-zone temperature control & Buffer tank control

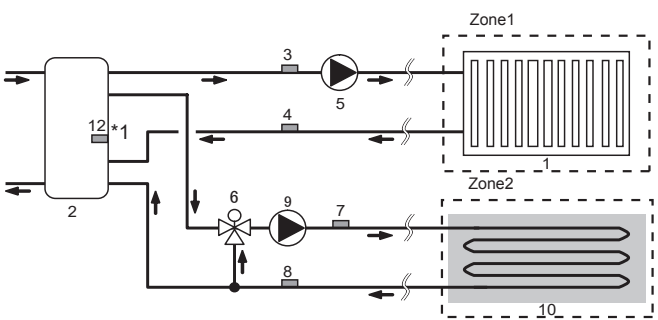

1-zone temperature control (2-zone valve ON/OFF control)

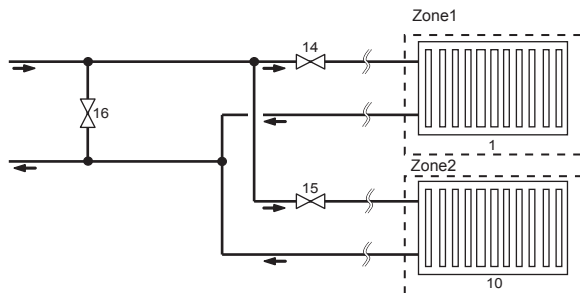

1. Zone1 heat emitters (e.g. radiator, fan coil unit) (local supply)
2. Mixing tank (local supply)
3. Zone1 flow water temp. thermistor (THW6)
4. Zone1 return water temp. thermistor (THW7) } Optional part: PAC-TH011-E
5. Zone1 water circulation pump (local supply)
6. Motorized mixing valve (local supply)
7. Zone2 flow water temp. thermistor (THW8)
8. Zone2 return water temp. thermistor (THW9) } Optional part: PAC-TH011-E
9. Zone2 water circulation pump (local supply)

10. Zone2 heat emitters (e.g. underfloor heating) (local supply)
11. Boiler flow water temp. thermistor (THWB1) } Optional part: PAC-TH012HT(L)-E
12. Mixing tank thermistor (THW10) *1
13. Boiler (local supply)
14. Zone1 2-way valve (local supply)
15. Zone2 2-way valve (local supply)
16. Bypass valve (local supply)

*1 ONLY Buffer tank control (heating/cooling) applies to "Smart grid ready".

Filling the System (Primary Circuit)

1. Check and charge expansion vessel.
2. Check all connections including factory fitted ones are tight.
3. Insulate pipe work between hydrobox and outdoor unit.
4. Thoroughly clean and flush, system of all debris. (Refer to 4.2 in the installation manual.)
5. Fill primary heating circuit with water and suitable anti-freeze and inhibitor as necessary. **Always use a filling loop with double check valve when filling the primary circuit to avoid back flow contamination of water supply.**

- Anti-freeze should always be used for package systems. It is the responsibility of the installer to decide if anti-freeze solution should be used in split systems depending on each site's conditions. Corrosion inhibitor should be used in both split and package systems. Figure below shows freezing temperature against anti-freeze concentration. This figure is an example for FERNOX ALPHI-11. For other anti-freeze, please refer to relevant manual.
- When connecting metal pipes of different materials, insulate the joints to prevent a corrosive reaction taking place which will damage the pipework.

6. Check for leakages. If leakages are found, retighten the screws on the connections.
7. Pressurise system to 1 bar.
8. Release all trapped air using air vents during and following heating period.
9. Top up with water as necessary. (If pressure falls below 1 bar)
10. After removing the air, automatic air vent **MUST** be closed.

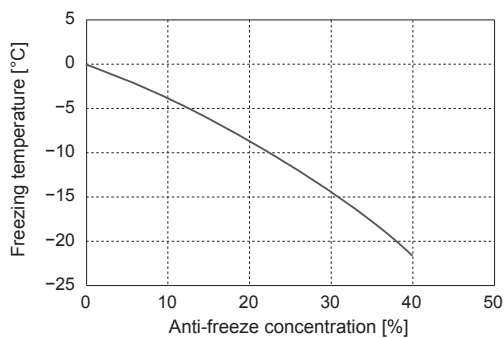

Draining the Hydrobox

WARNING: DRAINED WATER MAY BE VERY HOT

1. Before attempting to drain the hydrobox, isolate from the electrical supply to prevent booster heater burning out.
2. Isolate hydrobox from primary water circuit and drain water from hydrobox. Use a suitable heat resistant hose to assist in these operations.
3. Drain any remaining water from booster heater using fitted drain cock and hose, and the drain valve on the primary circuit to safely drain the unit.
4. After the hydrobox is drained, water remains in the following component parts. Drain water completely by checking the inside of the parts.
 - Strainer (Remove the strainer cover.)
 - Pressure relief valve (Operate the valve.)

9-1. Main remote controller

To change the settings of your heating/cooling system please use the main remote controller located on the front panel of the cylinder unit or hydrobox. The following is a guide to viewing the main settings. Should you require more information please contact your installer or local Mitsubishi Electric dealer. Cooling mode is available for ERS series only. However, Cooling mode is not available when the indoor unit is connected to PUHZ-FRP.

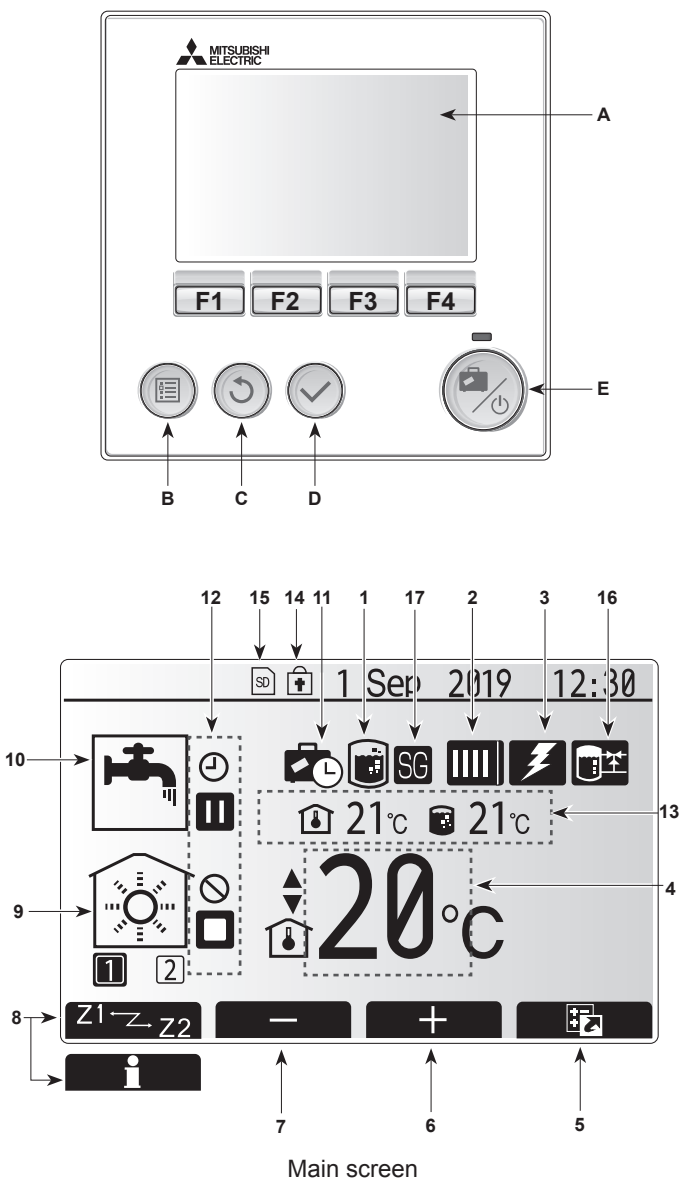

Main screen

<Main remote controller parts>

Letter	Name	Function
A	Screen	Screen in which all information is displayed.
B	Menu	Access to system settings for initial set up and modifications.
C	Back	Return to previous menu.
D	Confirm	Used to select or save. (Enter key)
E	Power/Holiday	If system is switched off pressing once will turn system ON. Pressing again when system is switched on will enable Holiday Mode. Holding the button down for 3 secs will turn the system off. (*1)
F1-4	Function keys	Used to scroll through menu and adjust settings. Function is determined by the menu screen visible on screen A.

*1 When the system is switched off or the power supply is disconnected, the indoor unit protection functions (e.g. freeze stat. function) will NOT operate. Please beware that without these safety functions the enabled indoor unit may potentially become exposed to damage.

<Main screen icons>

Icon	Description
1	Legionella prevention When this icon is displayed, 'Legionella prevention mode' is active.
2	Heat pump 'Heat pump' is running. Defrosting Emergency heating 'Quiet mode' is activated.
3	Electric heater When this icon is displayed, the 'Electric heaters' (booster or immersion heater) are in use.
4	Target temperature Target flow temperature Target room temperature Compensation curve
5	OPTION Pressing the function button below, this icon will display the option screen.
6	+ Increase set temperature.
7	- Decrease set temperature.
8	Z1 Z2 Pressing the function button below, this icon switches between Zone1 and Zone2. Information Pressing the function button below, this icon displays the information screen.
9	Space heating (cooling) mode Heating mode Zone1 or Zone2 Cooling mode Zone1 or Zone2
10	DHW mode Normal or ECO mode
11	Holiday mode When this icon is displayed, 'Holiday mode' activated.
12	Timer Prohibited Server control Stand-by Stand-by (*2) Stop Operating
13	Current temperature Current room temperature Current water temperature of DHW tank
14	The Menu button is locked or the switching of the operation modes between DHW and Heating operations are disabled in the Option screen. (*3)
15	SD memory card (NOT for the user) is inserted.
16	Buffer tank control When this icon is displayed, 'Buffer tank control' is active.
17	Smart grid ready When this icon is displayed, 'Smart grid ready' is active.

*2 This unit is in Stand-by whilst other indoor unit(s) is in operation by priority.

*3 To lock or unlock the Menu, press the BACK and CONFIRM keys simultaneously for 3 seconds.

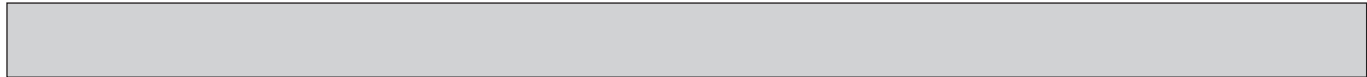

9-2. Setting the Main remote controller

After the power has been connected to the outdoor and hydrobox (See "7. FIELD WIRING"), the initial system settings can be entered via the main remote controller.

1. Check all breakers and other safety devices are correctly installed and turn on power to the system.
2. When the main remote controller is switched on for the first time, the screen automatically goes to Initial settings menu, Language setting screen and Date/Time setting screen in order.
3. Main remote controller will automatically start up. Wait approximately 6 minutes whilst the control menus load.
4. When the controller is ready, a blank screen with a line running across the top will be displayed.
5. Press button E (Power) (refer to 9-1. Main remote controller) to turn on the system. Before turning on the system, perform initial settings as instructed below.

9-3. Main Settings Menu

The main settings menu can be accessed by pressing the MENU button. To reduce the risk of untrained end users altering the settings accidentally, there are 2 access levels to the main settings; and the service section menu is password protected.

User Level – Short press

If the MENU button is pressed once for a short time, the main settings will be displayed but without the edit function. This will enable the user to view current settings but **NOT** change the parameters.

Installer Level – Long press

If the MENU button is pressed down for 3 seconds, the main settings will be displayed with all functionality available.

The colour of ◀▶ buttons is inverted as per right figure.

The following items can be viewed and/or edited (dependent on access level).

- Domestic Hot water (DHW)
- Heating/Cooling
- Schedule timer
- Holiday mode
- Initial settings
- Service (Password protected)

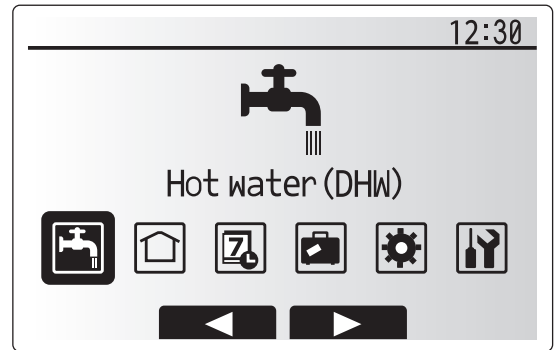

Main menu



General Operation

- To find the icon that you wish to set, use the F2 and F3 buttons to move between the icons.
- The highlighted icon will appear as a larger version of the centre of the screen.
- Press CONFIRM to select and edit the highlighted mode.
- Follow the <Main remote controller Menu Tree> for further setting, using ◀▶ buttons for scrolling or F1 to F4 for selecting.

<Main Controller Menu Tree>

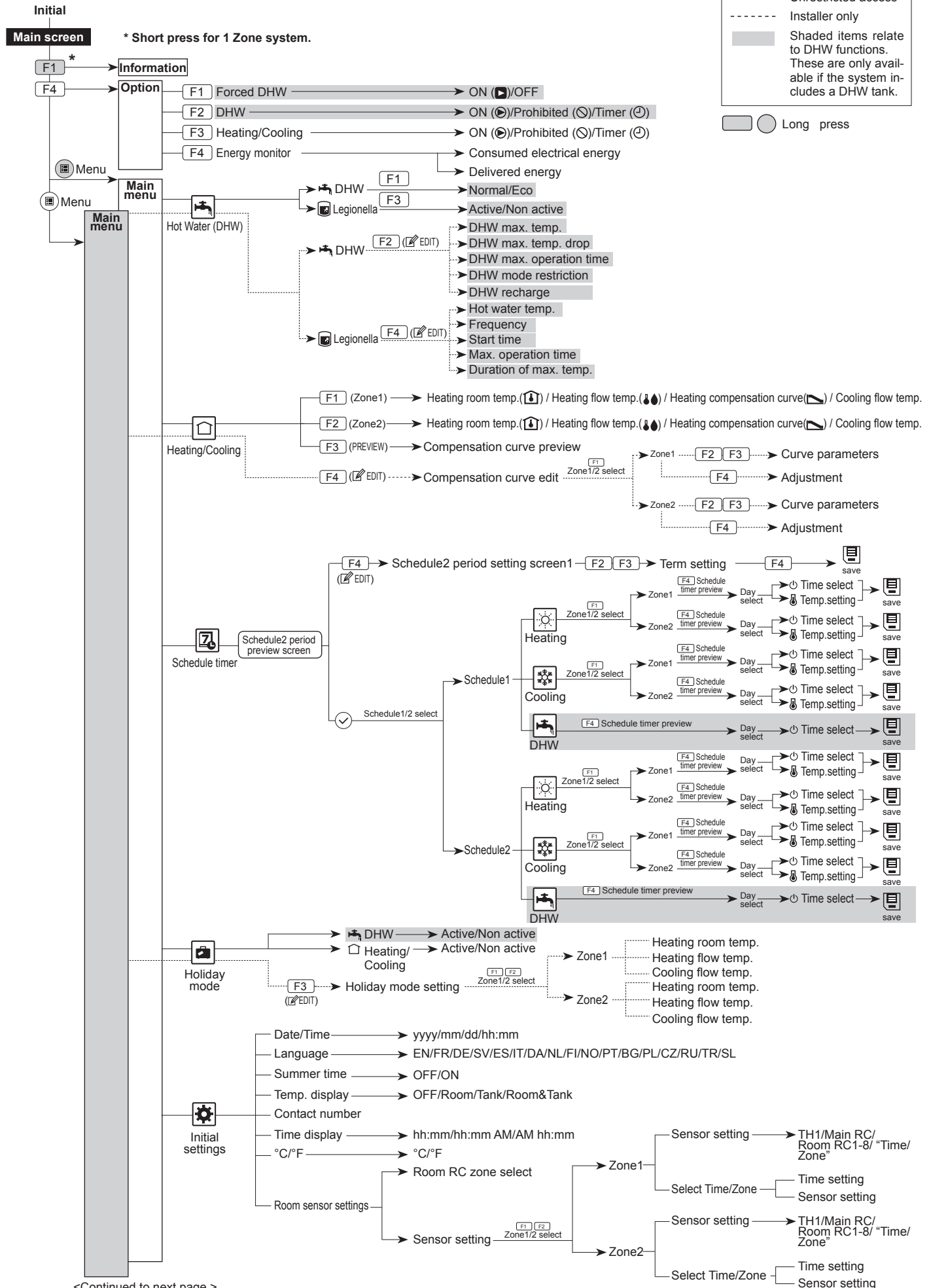

— Unrestricted access
 - - - - - Installer only
 ■ Shaded items relate to DHW functions. These are only available if the system includes a DHW tank.

☐ ○ Long press

<Continued to next page.>

<Continued from the previous page.>

<Main Controller Menu Tree>

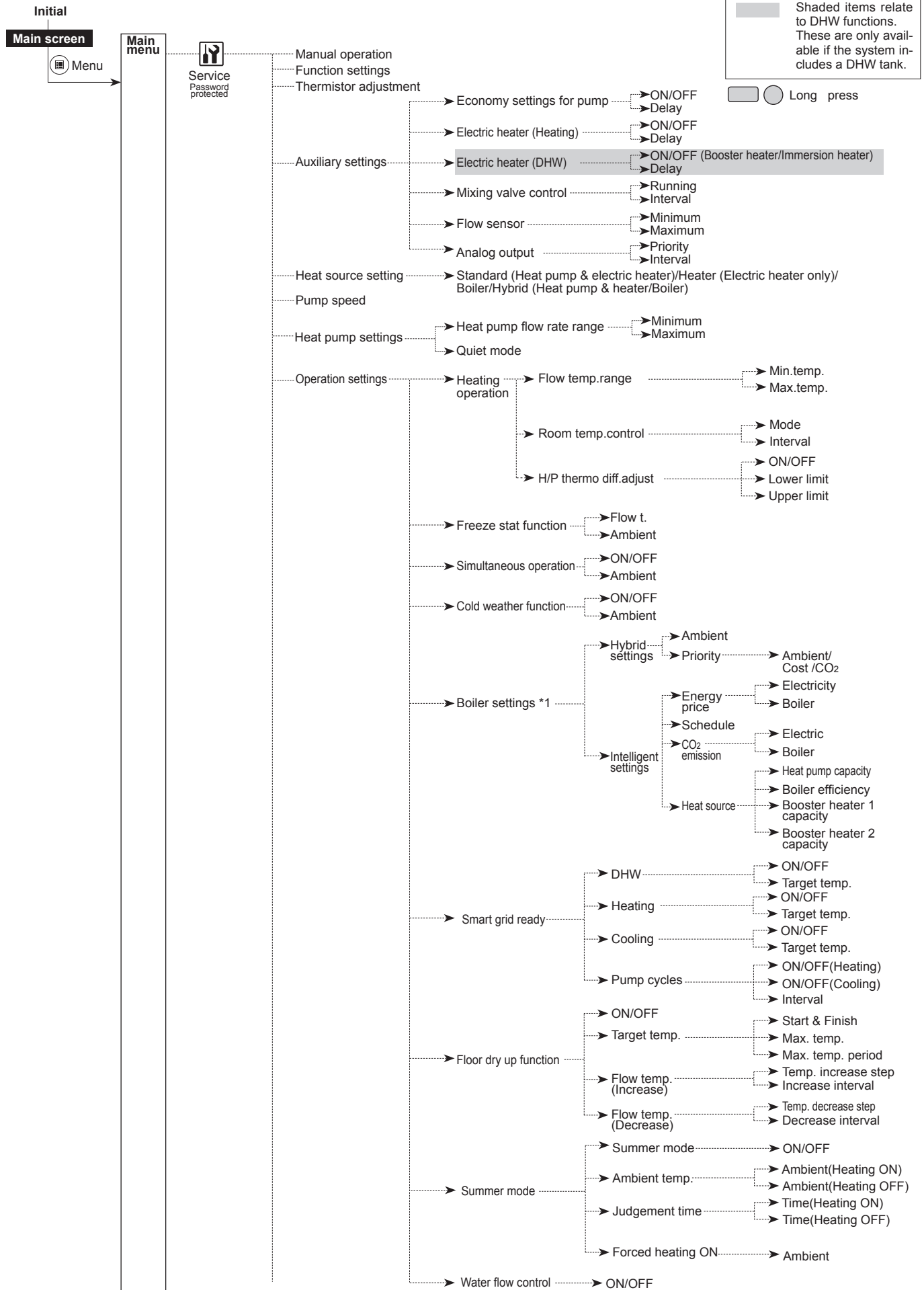

— Unrestricted access
 - - - - - Installer only
 ■ Shaded items relate to DHW functions. These are only available if the system includes a DHW tank.
 ◻ ◯ Long press

*1 For more details, refer to the installation manual of PAC-TH012HT(L)-E.

<Continued from the previous page.>

<Main Controller Menu Tree>

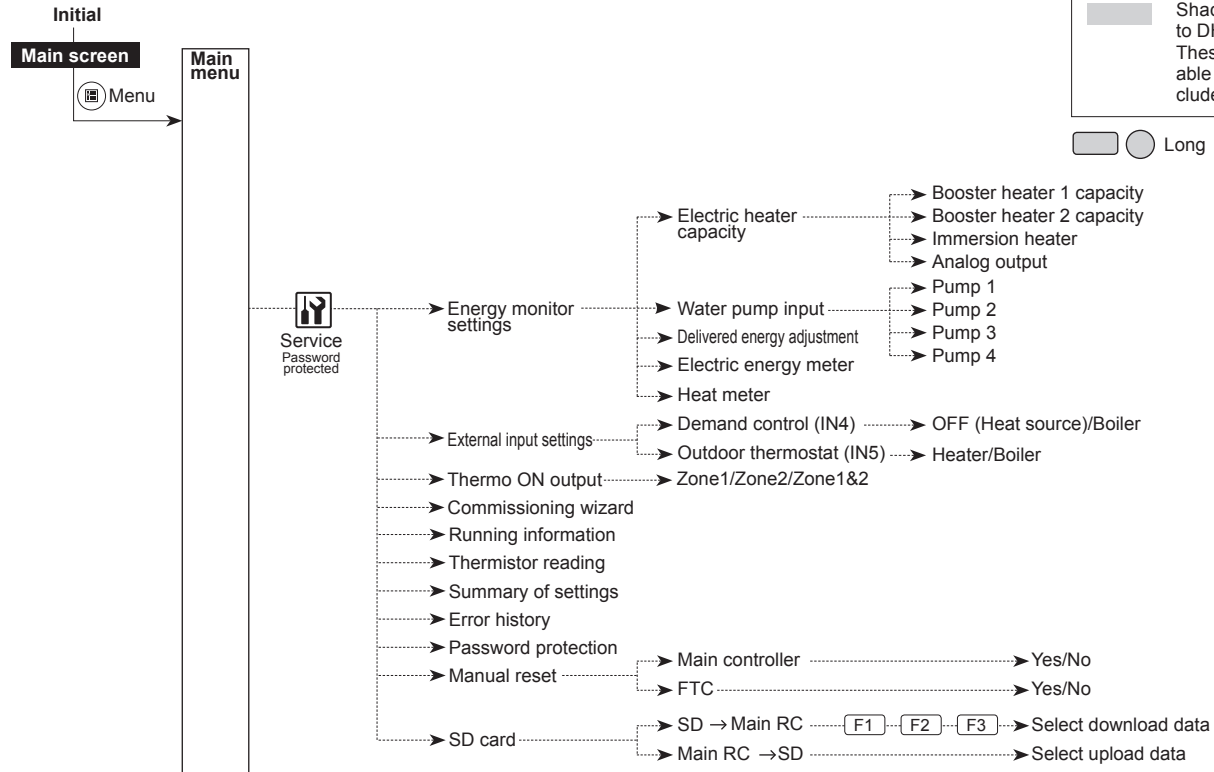

— Unrestricted access
 - - - - - Installer only
 ■ Shaded items relate to DHW functions. These are only available if the system includes a DHW tank.

Long press

9-4. Service Menu

The service menu provides functions for use by installer or service engineer. It is NOT intended the home owner alters settings within this menu. It is for this reason password protection is required to prevent unauthorised access to the service settings.

The factory default password is "0000".

Follow the procedure described in General Operation for the set up operation.

The service menu is navigated using the F1 and F2 buttons to scroll through the functions. The menu is split across 2 screens and is comprised of the following functions;

1. Manual operation
2. Function settings
3. Thermistor adjustment
4. Auxiliary settings
5. Heat source setting
6. Pump speed
7. Operation settings
8. Energy monitor settings
9. External input settings
10. Running information
11. Thermistor reading
12. Summary of settings
13. Error history
14. Password protection
15. Manual reset
16. SD card

Many functions cannot be set whilst the indoor unit is running. The installer should turn off the unit before trying to set these functions. If the installer attempts to change the settings whilst the unit is running, the main remote controller will display a reminder message prompting the installer to stop operation before continuing. By selecting "Yes", the unit will cease operation.

<Manual operation>

During the filling of the system the water circulation pump and 3-way valve can be manually overridden using manual operation mode.

When manual operation is selected a small timer icon appears in the screen.

The function selected will only remain in manual operation for a maximum of 2 hours. This is to prevent accidental permanent override of the FTC.

► Example

Pressing F3 button will switch manual operation mode ON for the main 3-way valve. When filling of the DHW tank is complete the installer should access this menu again and press F3 to deactivate manual operation of the part. Alternatively after 2 hours manual operation mode will no longer be active and FTC will resume control of the part.

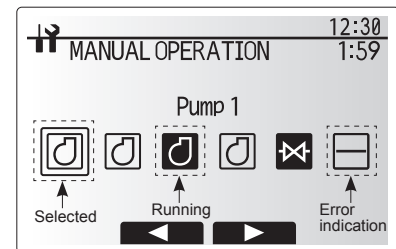

Manual operation menu screen

Manual operation and heat source setting cannot be selected if the system is running. A screen will be displayed asking the installer to stop the system before these modes can be activated. The system automatically stops 2 hours after the last operation.

<Function settings>

Function Setting allows the setting of auto recovery after power failure and of smart grid ready.

1. From the service menu use F1 and F2 to highlight Function Setting.
2. Press CONFIRM.
3. Ensure the Ref address and unit number are displayed to the right.
4. Press CONFIRM.
5. Use F3 and F4 to highlight either 1/2/3 (see below).
6. Press CONFIRM.

Setting	Unit	Mode	Number
Auto recovery after power failure	Grp	Mode1	1 - Inactive 2 - Active *1 3 - NO FUNCTION

*1 Approx. 4-minute delay after power is restored.

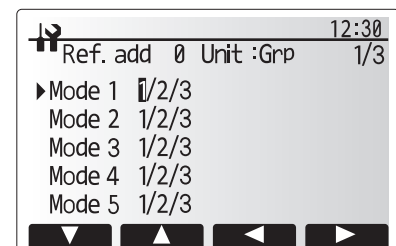
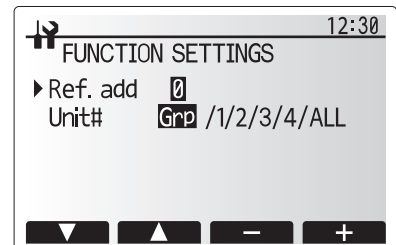

<Thermistor adjustment>

This function allows adjustments to be made to the thermistor readings from -10 to 10°C in 0.5°C intervals.

- THW1: Thermistor (Flow water temp.)
- THW2: Thermistor (Return water temp.)
- THW5B: Thermistor (DHW tank water temp.)(Option)
- THW6: Thermistor (Zone1 flow temp.)(Option)
- THW7: Thermistor (Zone1 return temp.)(Option)
- THW8: Thermistor (Zone2 flow temp.)(Option)
- THW9: Thermistor (Zone2 return temp.)(Option)
- THW10: Thermistor (Mixing tank water temp.)
- THWB1: Thermistor (Boiler flow temp.)(Option)

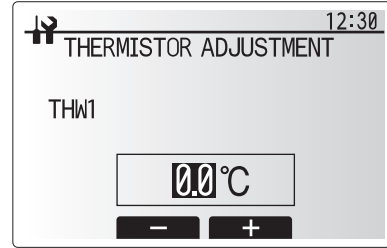

<Auxiliary settings>

This function is used to set the parameters for any auxiliary parts used in the system

Menu subtitle	Function/Description
Economy settings for pump	Water pump stops automatically in certain period of time from when operation is finished.
Delay	Time before pump switched off *1
Electric heater (Heating)	To select "WITH booster heater (ON)" or "WITHOUT booster heater (OFF)" in Heating mode.
Delay	The minimum time required for the booster heater to turn ON from after Heating mode has started.
Electric heater (DHW)	To select "WITH (ON)" or "WITHOUT (OFF)" booster heater or immersion heater individually in DHW mode.
Delay	The minimum time required for the booster heater or immersion heater to turn ON from after DHW mode has started. (This setting is applied for both booster and immersion heater.)
Mixing valve control *2	Period from valve fully open (at a hot water mixing ratio of 100%) to valve fully closed (at a cold water mixing ratio of 100%)
Running Interval	Interval (min.) to control the Mixing valve.
Flow sensor *3	The minimum flow rate to be detected at Flow sensor.
Maximum	The maximum flow rate to be detected at Flow sensor.

*1 Decreasing "time before pump switched off" may increase the duration of stand-by in Heating/Cooling mode.

*2 Set the Running time according to the specifications of the actuator of each mixing valve. It is recommended to set the interval to 2 minutes that is a default value. With the interval set longer, it could take longer to warm up a room.

*3 Do not change the setting since it is set according to the specification of Flow sensor attached to the hydrobox.

Economy settings for pump

1. From the Auxiliary settings menu, highlight Economy Settings for water circulation pump.
2. Press CONFIRM.
3. The economy settings for water circulation pump screen is displayed.
4. Use button F1 to switch the economy settings ON/OFF.
5. Use buttons F3 and F4 to adjust the time the water circulation pump will run. (3 to 60 minutes)

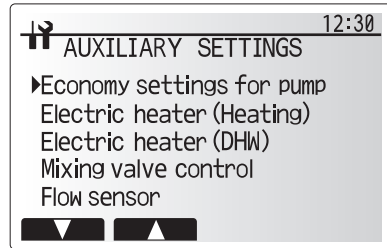

Auxiliary settings menu screen

Electric heater (Heating)

1. From the Auxiliary settings menu, highlight Electric heater (Heating).
2. Press CONFIRM.
3. The Electric heater (Heating) screen is displayed.
4. Press F1 button to switch the function ON/OFF.
5. Use F3 and F4 buttons to adjust the time period of heat pump only operation before the booster heater will assist in space heating. (5 to 180 minutes)

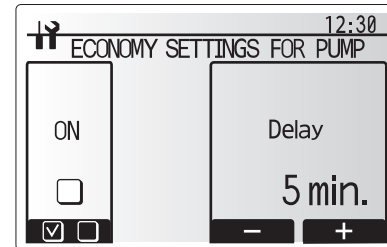

Economy settings for pump screen

Electric heater (DHW)

1. From the Auxiliary settings menu, highlight Electric heater (DHW).
2. Press CONFIRM.
3. The Electric heater (DHW) screen is displayed.
4. Press F1 button to switch the function ON/OFF.
5. Use F3 and F4 buttons to adjust the time period of heat pump only operation before the booster heater and the immersion heater (if present) will assist in DHW heating. (15 to 30 minutes)

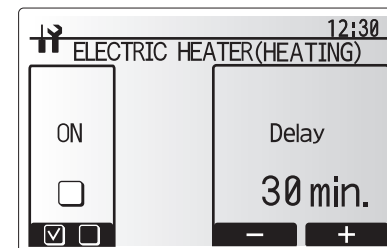

Electric heater (Heating) screen

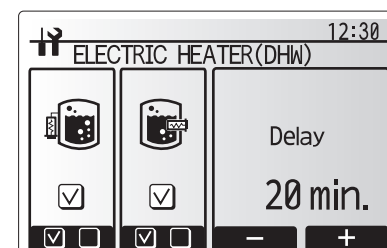

Electric heater (DHW) screen

Mixing valve control

1. From the Auxiliary settings menu, highlight Mixing valve control.
2. Press CONFIRM.
3. The Mixing valve control screen is displayed.
4. Use F1 and F2 buttons to set Running time between 10 to 240 seconds. The Running time equals to a period from full open of the valve (at a hot water mixing ratio of 100%) to full close (at a cold water mixing ratio of 100%).

Note: Set the Running time according to the specifications of the actuator of each mixing valve.

1. From the Auxiliary settings menu, highlight Mixing valve control.
2. Press CONFIRM.
3. The Mixing valve control screen is displayed.
4. Press F3 and F4 buttons to set the interval between 2-zone temperature controls of the mixing valve between 1 to 30 minutes.

Note: It is recommended to set the interval to 2 minutes that is a default value. With the interval set longer, it could take longer to warm up a room.

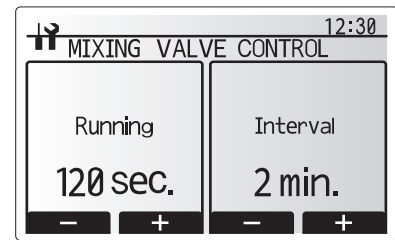

Mixing valve control setting screen

Flow sensor

1. From the Auxiliary settings menu, highlight Flow sensor.
 2. Press CONFIRM.
 3. Press F3 or F4 buttons to select a refrigerant address of which you wish to configure or check the settings, and press CONFIRM. *1
 4. The Flow sensor screen is displayed.
 5. Use F1 and F2 buttons to set the minimum flow rate of flow sensor between 0 to maximum L/min.
 6. Use F3 and F4 buttons to set the maximum flow rate of flow sensor between minimum to 100L/min.
- *1 For multiple outdoor units control system only.

Note: Do not change the setting since it is set according to the specification of Flow sensor attached to the hydrobox.

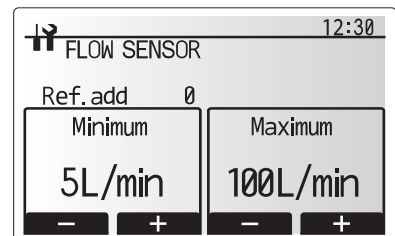

Flow sensor setting screen

<Heat source setting>

The default heat source setting is heat pump and all electric heaters present in the system to be operational. This is referred to as Standard operation on the menu.



Heat source setting screen

<Pump speed>

1. From the Service menu, highlight Pump speed.
 2. Press CONFIRM.
 3. Press F3 and F4 buttons to select a refrigerant address of which you wish to configure or check the settings, and press CONFIRM. *1
 4. The Pump speed screen is displayed.
 5. Use F1 and F2 buttons to set the pump speed (1 to 5) of DHW operation.
 6. Use F3 and F4 buttons to set the pump speed (1 to 5) of space heating(cooling) operation.
- *1 For multiple outdoor units control system only.

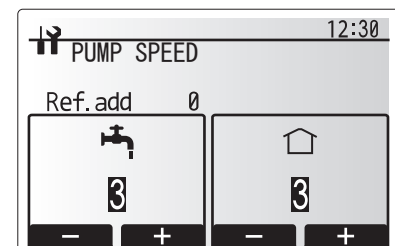

Pump speed setting screen

<Operation settings>

Heating operation

This function allows operational setting of flow temperature range from the Ecodan and also the time interval at which the FTC collects and processes data for the auto adaptation mode.

Menu subtitle		Function	Range	Unit	Default
Flow temp. range	Minimum temp.	To minimize the loss by frequent ON and OFF in mild outdoor ambient temperature seasons.	20 to 45	°C	30
	Maximum temp.	To set max. possible flow temperature according to the type of heat emitters.	35 to 60	°C	50
Room temp. control	Mode	Setting for Room temp. control At Fast mode, target outlet water temperature is set higher than the one set at normal mode. This reduces the time to reach the target room temperature when the room temperature is relatively low.*1	Normal/ Fast	—	Normal
	Interval	Selectable according to the heat emitter type and the materials of floor (i.e. radiators, floor heating-thick, -thin concrete, wood, etc.)	10 to 60	min	10
Heat pump thermo diff.adjust	ON/OFF	To minimize the loss by frequent ON and OFF in mild outdoor ambient temperature seasons.	ON/OFF	—	ON
	Lower limit	Prohibits heat pump operation until the flow temperature drops below the target flow temperature plus lower limit value.	-9 to -1	°C	-5
	Upper limit	Allows heat pump operation until the flow temperature rises above the target flow temperature plus upper limit value.	+3 to +5	°C	+5

< Heating operation (Room temp. control) >

Notes:

1. The minimum flow temperature that prohibits heat pump operation is 20°C.
2. The maximum flow temperature that allows heat pump operation equals to the maximum temperature set in the Flow temp. range menu.

*1 Fast mode is not efficient and will increase running cost compared to normal mode.

Freeze stat function

Menu subtitle	Function/Description
Freeze stat function *2	An operational function to prevent the water circuit from freezing when outdoor ambient temperature drops.
Flow t.	The target outlet water temperature at water circuit when operating in Freeze stat function.*3
Outdoor ambient temp.	Minimum outdoor ambient temperature which freeze stat function will begin to operate, (3 to 20°C) or choose**. If asterisk (**) is chosen freeze stat function is deactivated. (i.e. primary water freeze risk)

*2 When the system is turned off, freeze stat function is not enabled.

*3 Flow t. is fixed to 20°C and unchangeable.

Simultaneous Operation

For periods of very low outside temperature, this mode can be used. Simultaneous operation allows both DHW and space heating to run together by using the heat pump and/or booster heater to provide space heating whilst only the immersion heater provides heating for DHW. This operation is only available if BOTH a DHW tank AND immersion heater are present on the system.

- Range of outdoor ambient temperature at which simultaneous operation starts is -30 to 10°C (default -15°C).
- System shall automatically return to routine operation. This will happen when the outdoor ambient temperature rises above the selected temperature for this specific mode of operation.

Cold weather function

For extremely low outdoor ambient temperature conditions when the heat pump's capacity is restricted, the heating or DHW is provided only by the electric booster heater (and immersion if present). This function is intended for use during extreme cold periods only. Extensive use of direct electrical heaters ONLY will result in higher power consumption and may reduce working life of heaters and related parts.

- Range of outdoor ambient temperature at which cold weather function starts is -30 to -10°C (default -15°C).
- System shall automatically return to routine operation. This will happen when the outdoor ambient temperature rises above the selected temperature for this specific mode of operation.

Floor dry up function

The Floor dry up function automatically changes the target hot water temperature in stages to gradually dry concrete when this particular type of underfloor heating system is installed.

Upon completion of the operation, the system stops all the operations except the Freeze stat. operation.

For Floor dry up function, the target flow temp. of Zone1 is the same as that of Zone2.

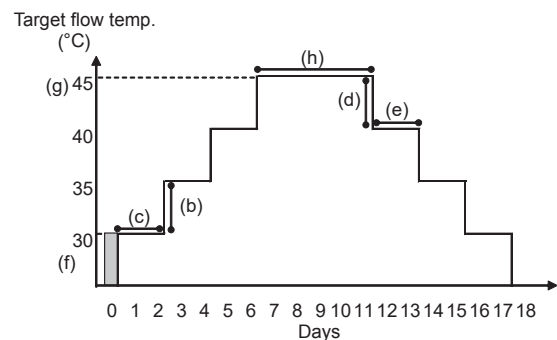

- This function is not available when a PUAZ-FRP outdoor unit is connected.
- Disconnect wiring to external inputs of room thermostat, demand control, and outdoor thermostat, or the target flow temperature may not be maintained.

Functions	Symbol	Description	Option/Range	Unit	Default	
Floor dry up function	a	Sets the function to ON and power on the system using the main remote controller, and the dry up heating operation will start.	ON/OFF	—	OFF	
Flow temp. (increase)	Flow temp. increase step	b	Sets the increase step of the target flow temperature.	+1 to +10	°C	+5
	Increase interval	c	Sets the period for which the same target flow temperature is maintained.	1 to 7	day	2
Flow temp. (decrease)	Flow temp. decrease step	d	Sets the decrease step of the target flow temperature.	-1 to -10	°C	-5
	Decrease interval	e	Sets the period for which the same target flow temperature is maintained.	1 to 7	day	2
Target temperature	Start & Finish	f	Sets the target flow temperature at the start and the finish of the operation.	20 to 60	°C	30
	Max. target temp.	g	Sets the maximum target flow temperature.	20 to 60	°C	45
	Max. temp. period	h	Sets the period for which the maximum target flow temperature is maintained.	1 to 20	day	5

<Energy monitor settings>

1. General description

End user can monitor accumulated (*1) 'Consumed electrical energy' and 'Delivered heat energy' in each operation mode (*2) on the main remote controller.

*1 Monthly and Year to date

*2 - DHW operation

- Space heating
- Space cooling

Refer to the menu tree in "9-3. Main Settings Menu" for how to check the energy, and "6-6. DIP switch functions" for the details on DIP-SW setting.

Either one of the following 2 methods is used for monitoring.

Note: Method 1 should be used as a guide. If a certain accuracy is required, method 2 should be used.

(1) Calculation internally [Method 1]

Electricity consumption is calculated internally based on the energy consumption of outdoor unit, electric heater, water pump(s) and other auxiliaries.*1

Delivered heat is calculated internally by multiplying delta T (Flow and Return temp.) and flow rate measured by the factory fitted sensors.

Set the electric heater capacity and water pump(s) input according to indoor model name and specs of additional pump(s) supplied locally. (Refer to the menu tree in "9-3. Main Settings Menu")

	Booster heater1	Booster heater2	Pump1 * 2	Pump2	Pump3
Default	2 kW	4 kW	***(factory fitted pump)	0 kW	0 kW
EHSD-MED	0 kW	0 kW	***	When additional pumps supplied locally are connected as Pump2/3, change setting according to specs of the pumps.	
EHSD-VM2D	2 kW	0 kW	***		
EHSD-VM6D	2 kW	4 kW	***		
EHSD-YM9D	3 kW	6 kW	***		
EHSD-YM9ED	3 kW	6 kW	***		
EHSD-TM9D	3 kW	6 kW	***		
EHSC-MED	0 kW	0 kW	***		
EHSC-VM2D	2 kW	0 kW	***		
EHSC-VM6D	2 kW	4 kW	***		
EHSC-YM9D	3 kW	6 kW	***		
EHSC-YM9ED	3 kW	6 kW	***		
EHSC-TM9D	3 kW	6 kW	***		
ERSD-VM2D	2 kW	0 kW	***		
ERSD-VM6D	2 kW	4 kW	***		
ERSD-YM9D	3 kW	6 kW	***		
ERSC-MED	0 kW	0 kW	***		
ERSD-MED	0 kW	0 kW	***		
ERSC-VM2D	2 kW	0 kW	***		
ERSC-VM6D	2 kW	4 kW	***		
ERSC-YM9D	3 kW	6 kW	***		
EHSE-MED	0 kW	0 kW	***		
EHSE-YM9ED	3 kW	6 kW	***		
ERSE-MED	0 kW	0 kW	***		
ERSE-YM9ED	3 kW	6 kW	***		
EHPX-MED	0 kW	0 kW	***		
EHPX-VM2D	2 kW	0 kW	***		
EHPX-VM6D	2 kW	4 kW	***		
EHPX-YM9D	3 kW	6 kW	***		
EHPX-YM9ED	3 kW	6 kW	***		
ERPX-MD	0 kW	0 kW	***		
ERPX-VM2D	2 kW	0 kW	***		
ERPX-VM6D	2 kW	4 kW	***		
ERPX-YM9D	3 kW	6 kW	***		

*1 When the hydrobox is connected with a PUHZ-FRP or PUMY models, electricity consumption is not calculated internally. To display the electricity consumption, conduct the method 2.

*2 "****" displayed in the energy monitor setting mode means the factory fitted pump is connected as Pump 1 so that the input is automatically calculated.

When anti-freeze solution (propylene glycol) is used for primary water circuit, set the delivered energy adjustment if necessary.

For further detail of above, refer to the menu tree in "9-3. Main Settings Menu".

(2) Actual measurement by external meter [Method 2] (locally supplied)

FTC has external input terminals for 2 'Electric energy meters' and a 'Heat meter'.

If two 'Electric energy meters' are connected, the 2 recorded values will be combined at the FTC and shown on the main remote controller.

(e.g. Meter 1 for H/P power line, Meter 2 for heater power line)

Refer to the [Signal inputs] in "6. WIRING DIAGRAM" for more information on connectable electric energy meter and heat meter.

• Connectable electric energy meter and heat meter

- Pulse meter type Voltage free contact for 12 VDC detection by FTC (TBI.3 1, 3 and 5 pin have a positive voltage.)
- Pulse duration Minimum ON time: 40 ms
Minimum OFF time: 100 ms
- Possible unit of pulse 0.1 pulse/kWh 1 pulse/kWh 10 pulse/kWh
100 pulse/kWh 1000 pulse/kWh

Those values can be set by the main remote controller. (Refer to the menu tree in "9-3. Main Settings Menu".)

2. Settings using the main remote controller

In this menu, all parameters required to record the consumed electrical energy and the delivered heat energy which is displayed on the main remote controller can be set. The parameters are an electric heater capacity, supply power of water pump and heat meter pulse.

Follow the procedure described in General Operation for the set up operation.

For Pump 1, *** can be also set besides this setting.

In the case *** is selected, the system acknowledges "factory fitted pump" is selected.

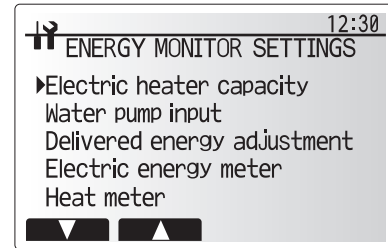

Energy monitor settings menu screen

<External input settings>

Demand control(IN4)

The selection of "OFF", whilst a signal is being sent to IN4, forcefully stops all the heat source operations and the selection of "Boiler" stops operations of heat pump and electric heater and performs boiler operation.

Outdoor thermostat (IN5)

The selection of "Heater", whilst a signal is being sent to IN5, performs electric-heater-only operation and the selection of "Boiler" performs boiler operation.

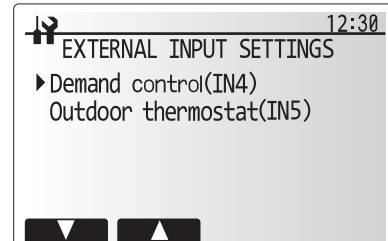

External input settings menu screen

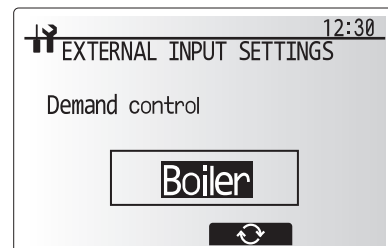

Demand control screen

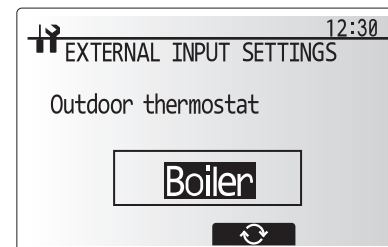

Outdoor thermostat setting screen

<Running information>

This function shows current temperature and other data of main component parts of both the indoor and outdoor units.

1. From the Service menu highlight Running information.
2. Press CONFIRM.
3. Press F3 and F4 buttons to set the Ref. address. *1
4. Use the function buttons to enter index code for the component to be viewed.
(See the Table 9-4-1 for component index codes.)
5. Press CONFIRM.

*1 For multiple outdoor units control system only.

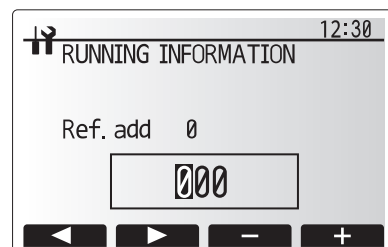

<Thermistor reading>

This function shows the current readings of thermistors located on the water and refrigerant circuit

Thermistor	Description	Thermistor	Description
TH1A	Zone1 room temperature	TH7	Ambient (outdoor) temperature
TH1B	Zone2 room temperature	THW6	Zone1 flow temperature
TH2	Refrigerant liquid temperature	THW7	Zone1 return temperature
THW1	Flow water temperature	THW8	Zone2 flow temperature
THW2	Return water temperature	THW9	Zone2 return temperature
THW5A	DHW tank water temperature (upper)	THW10	Mixing tank temperature
THW5B	DHW tank water temperature (lower)	THWB1	Boiler flow temperature

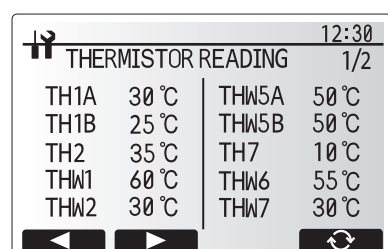

<Summary of settings>

This function shows the current installer/user entered settings.

Abbreviation	Explanation	Abbreviation	Explanation
HWtemp	DHW max temperature	Z2 mode	Operation mode
HWdrop	DHW temperature drop		- HER (Heating room temperature)
HWtime	DHW max operation time		- HE (Heating flow temperature)
NO HW	DHW mode restriction		- HCC (Heating compensation curve)
HWset	DHW operation mode (Normal/Eco)		- COR (—)
			- CO (Cooling flow temperature)
Ltemp	Legionella hot water temperature	Hroom 1	Heating target room temperature
Lfreq	Legionella operation Frequency	Hroom 2	Heating target room temperature
Lstart	Legionella mode start time	Hflow 1	Heating target flow temperature
Ltime	Legionella max operation time	Hflow 2	Heating target flow temperature
Lkeep	Duration of max (Legionella) hot water temperature	Croom 1	Cooling target room temperature
		Croom 2	Cooling target room temperature
Z1 mode	Operation mode	Cflow 1	Cooling target flow temperature
	- HER (Heating room temperature)	Cflow 2	Cooling target flow temperature
	- HE (Heating flow temperature)	FSflow	Freeze stat function flow temperature
	- HCC (Heating compensation curve)	FSout	Freeze stat function ambient temperature
	- COR (—)		
	- CO (Cooling flow temperature)		

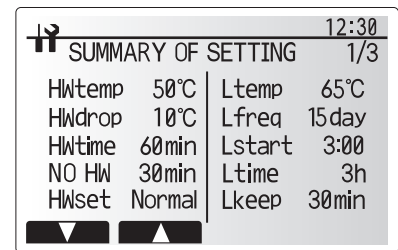

<Error history>

Error history allows the service engineer to view previous check codes, the unit address and the date on which they occurred. Up to 16 check codes can be stored in the history and the most recent Error event is displayed at the top of the list.

1. From the service menu, select Error history
2. Press CONFIRM.

Please see "10-4. Self diagnosis and action" for check codes diagnosis and actions.

To delete an Error history item;

1. From error history screen, press F4 button (Rubbish bin icon)
2. Then press F3 button (Yes).

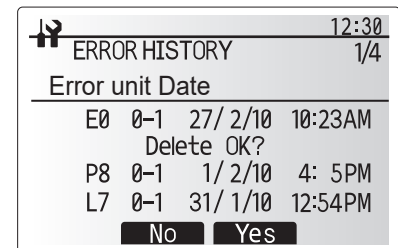
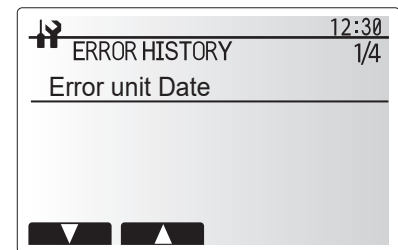

<Password protection>

Password protection is available to prevent unauthorised access to the service menu by untrained persons.

1. From the service menu, use F1 and F2 buttons to scroll through list until Password protection is highlighted.
2. Press CONFIRM.
3. When password input screen is displayed, use buttons F1 and F2 to move left and right between the 4 digits, F3 to lower the selected digit by 1, and F4 to increase the selected digit by 1.
4. When you have input your password, press CONFIRM.
5. The password verify screen is displayed.
6. To verify your new password, press button F3.
7. Your password is now set and the completion screen is displayed.



Password input screen



Password verify screen

Resetting the password

If you forget the password you entered, or have to service a unit somebody else installed, you can reset the password to the factory default of **0000**.

1. From the main settings menu, scroll down the functions until Service Menu is highlighted.
2. Press CONFIRM.
3. You will be prompted to enter a password.
4. Hold down buttons F3 and F4 together for 3 seconds.
5. You will be asked if you wish to continue and reset the password to default setting.
6. To reset press button F3.
7. The password is now reset to **0000**.



Completion screen

<Manual reset>

Should you wish to restore the initial settings at any time, you should use the manual reset function. Please note this will reset ALL functions to the factory default settings.

1. From the service menu, use F1 and F2 buttons to scroll through list until Manual Reset is highlighted.
2. Press CONFIRM.
3. The Manual reset screen is displayed.
4. Choose either Manual Reset for FTC or Main remote controller.
5. Press F3 button to confirm manual reset of chosen device.

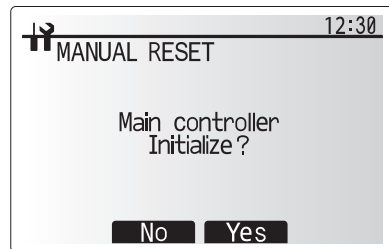
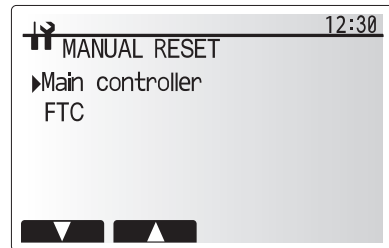

<SD card>

The use of an SD memory card simplifies the main remote controller settings in the field.

*Ecodan service tool (for use with PC tool) is necessary for the setting.

SD → Main RC

1. From the SD card setting, use F1 and F2 buttons to scroll through list until "SD → Main RC" is highlighted.
2. Press CONFIRM.
3. Press F3 and F4 buttons to set the Ref. address. *1
4. Use F1, F2 and F3 buttons to select a menu to write to the main remote controller.
5. Press CONFIRM to start downloading.
6. Wait for a few minutes until "Complete!" appears.

*1 For multiple outdoor units control system only.

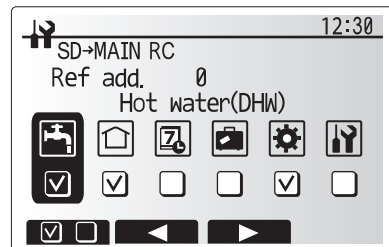
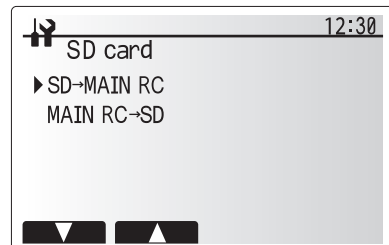

Main RC → SD

1. From the SD card setting, use F1 and F2 buttons to scroll through list until Main RC → SD is highlighted.
2. Press CONFIRM.
3. Press F3 and F4 buttons to set the Ref. address. *1
4. Use F1, F2 and F3 buttons to select a menu to write to the SD memory card.
5. Press CONFIRM to start uploading.
6. Wait for a few minutes until "Complete!" appears.

*1 For multiple outdoor units control system only.

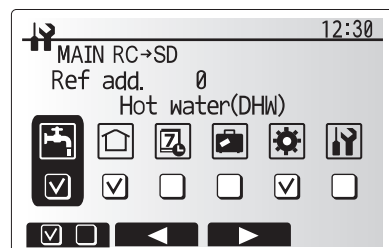

<Table 9-4-1> Request code in running information

Request code	Request content	Range	Unit
103	Error history 1 (latest)	Displays error history. ("--" is displays if no history is present.)	Code
104	Error history 2 (second to last)	Displays error history. ("--" is displays if no history is present.)	—
105	Error history 3 (third to last)	Displays error history. ("--" is displays if no history is present.)	—
154	Water circulation pump 1 - Accumulated operating time (after reset)	0 to 9999	10 hours
156	Water circulation pump 2 - Accumulated operating time (after reset)	0 to 9999	10 hours
157	Water circulation pump 3 - Accumulated operating time (after reset)	0 to 9999	10 hours
158	Water circulation pump 4 - Accumulated operating time (after reset)	0 to 9999	10 hours
162	Indoor unit - DIP SW1 setting information	Refer to detail contents described hereinafter.	—
163	Indoor unit - DIP SW2 setting information	Refer to detail contents described hereinafter.	—
164	Indoor unit - DIP SW3 setting information	Refer to detail contents described hereinafter.	—
165	Indoor unit - DIP SW4 setting information	Refer to detail contents described hereinafter.	—
166	Indoor unit - DIP SW5 setting information	Refer to detail contents described hereinafter.	—
175	Indoor unit - Output signal information	Refer to detail contents described hereinafter.	—
176	Indoor unit - Input signal information	Refer to detail contents described hereinafter.	—
177	Mixing valve opening step	0 to 10	Step
190	Indoor unit - Software version 1st 4 digits	Refer to Note below.	—
191	Indoor unit - Software version last 4 digits	Refer to Note below.	—
200	Initialisation of Function Setting	—	—
340	Water circulation pump 1 - Accumulated operating time reset	—	—
342	Water circulation pump 2 - Accumulated operating time reset	—	—
343	Water circulation pump 3 - Accumulated operating time reset	—	—
344	Water circulation pump 4 - Accumulated operating time reset	—	—
504	Indoor unit - Zone1 room temp. (TH1A)	-39 to +88	°C
505	Indoor unit - Ref. liquid temp. (TH2)	-39 to +88	°C
506	Indoor unit - Return water temp. (THW2)	-39 to +88	°C
507	Indoor unit - Zone2 room temp. (TH1B)	-39 to +88	°C
508	Indoor unit - DHW tank water temp. (THW5B)	-39 to +88	°C
509	Indoor unit - Zone1 flow water temp. (THW6)	-39 to +88	°C
510	Indoor unit - Outside air temp. (TH7)	-39 to +88	°C
511	Indoor unit - Flow water temp. (THW1)	-39 to +88	°C
512	Indoor unit - Zone1 return water temp. (THW7)	-39 to +88	°C
513	Indoor unit - Zone2 flow water temp. (THW8)	-39 to +88	°C
514	Indoor unit - Zone2 return water temp. (THW9)	-39 to +88	°C
515	Indoor unit - Boiler flow water temp. (THWB1)	-40 to +140	°C
535	Indoor unit - Mixing tank water temp. (THW10)	-40 to +140	°C
540	Flow rate of the primary circuit	0 to 100	L/min
550	Indoor unit - Error postponement history 1 (latest)	Displays postponement code. ("--" is displays if no postponement code is present.)	—
551	Indoor unit - Operation control at time of error	0 Standard, 1 Heater, 2 Boiler	—
552	Indoor unit - Operation mode at time of error	0: OFF, 1: DHW, 2 :Heating, 3: Cooling, 4: Legionella prevention, 5: Freeze protection, 6: Operation stop, 7: Defrost	—
553	Indoor unit - Output signal information at time of error	Refer to detail contents described hereinafter.	—
554	Indoor unit - Input signal information at time of error	Refer to detail contents described hereinafter.	—
555	Indoor unit - Zone1 room temp. (TH1A) at time of error	-39 to +88	°C
556	Indoor unit - Zone2 room temp. (TH1B) at time of error	-39 to +88	°C
557	Indoor unit - Ref. liquid temp. (TH2) at time of error	-39 to +88	°C
558	Indoor unit - Flow water temp. (THW1) at time of error	-39 to +88	°C
559	Indoor unit - Return water temp. (THW2) at time of error	-39 to +88	°C
560	Indoor unit - DHW tank water temp. (THW5B) at time of error	-39 to +88	°C
561	Indoor unit - Zone1 flow water temp. (THW6) at time of error	-39 to +88	°C
562	Indoor unit - Zone1 return water temp. (THW7) at time of error	-39 to +88	°C
563	Indoor unit - Zone2 flow water temp. (THW8) at time of error	-39 to +88	°C
564	Indoor unit - Zone2 return water temp. (THW9) at time of error	-39 to +88	°C
565	Indoor unit - Boiler flow water temp. (THWB1) at time of error	-40 to +140	°C
567	Indoor unit - Failure (P1/P2/L5/L8/Ld) thermistor	0: Failure thermistor is none, 1: TH1A, 2: TH2, 3: THW1, 4: THW2, 5: THWB1, 6: THW5B, 8: TH1B, A: THW6, B: THW7, C: THW8, D: THW9	—
568	Mixing valve opening step at time of error	0 to +10	Step
569	Operated Flow switch at time of failure (L9)	0: No operated flow switch, 1: Flow switch 1, 2: Flow switch 2, 3: Flow switch 3	—
571	Flow rate at time of error	0 to +100	L/min

Note:

Refer to outdoor unit service manual for request code 0 to 102, 106 to 149.

Request codes 103 to 105 indicate error histories of both indoor and outdoor units.

As only 4 digits can be displayed at one time the software version number is displayed in two halves.

Enter code 190 to see the first 4 digits and code 191 to see the last 4 digits.

For example software version No. 5.01 A000, when code 190 is entered 0501 is displayed, when code 191 is entered A000 is displayed.

Request code 200 resets all Function Setting to the factory default settings.

Indoor unit switch setting display (Request code: 162 to 166)

0: OFF 1: ON

SW1, SW2, SW3, SW4, SW5								Display
1	2	3	4	5	6	7	8	
0	0	0	0	0	0	0	0	00 00
1	0	0	0	0	0	0	0	00 01
0	1	0	0	0	0	0	0	00 02
1	1	0	0	0	0	0	0	00 03
0	0	1	0	0	0	0	0	00 04
1	0	1	0	0	0	0	0	00 05
0	1	1	0	0	0	0	0	00 06
1	1	1	0	0	0	0	0	00 07
0	0	0	1	0	0	0	0	00 08
1	0	0	1	0	0	0	0	00 09
0	1	0	1	0	0	0	0	00 0A
1	1	0	1	0	0	0	0	00 0B
0	0	1	1	0	0	0	0	00 0C
1	0	1	1	0	0	0	0	00 0D
0	1	1	1	0	0	0	0	00 0E
1	1	1	1	0	0	0	0	00 0F
0	0	0	0	1	0	0	0	00 10
1	0	0	0	1	0	0	0	00 11
0	1	0	0	1	0	0	0	00 12
1	1	0	0	1	0	0	0	00 13
0	0	1	0	1	0	0	0	00 14
1	0	1	0	1	0	0	0	00 15
0	1	1	0	1	0	0	0	00 16
1	1	1	0	1	0	0	0	00 17
0	0	0	1	1	0	0	0	00 18
1	0	0	1	1	0	0	0	00 19
0	1	0	1	1	0	0	0	00 1A
1	1	0	1	1	0	0	0	00 1B
0	0	1	1	1	0	0	0	00 1C
1	0	1	1	1	0	0	0	00 1D
0	1	1	1	1	0	0	0	00 1E
1	1	1	1	1	0	0	0	00 1F
0	0	0	0	0	1	0	0	00 20
1	0	0	0	0	1	0	0	00 21
0	1	0	0	0	1	0	0	00 22
1	1	0	0	0	1	0	0	00 23
0	0	1	0	0	1	0	0	00 24
1	0	1	0	0	1	0	0	00 25
0	1	1	0	0	1	0	0	00 26
1	1	1	0	0	1	0	0	00 27
0	0	0	1	0	1	0	0	00 28
1	0	0	1	0	1	0	0	00 29
0	1	0	1	0	1	0	0	00 2A
1	1	0	1	0	1	0	0	00 2B
0	0	1	1	0	1	0	0	00 2C
1	0	1	1	0	1	0	0	00 2D
0	1	1	1	0	1	0	0	00 2E
1	1	1	1	0	1	0	0	00 2F
0	0	0	0	1	1	0	0	00 30
1	0	0	0	1	1	0	0	00 31
0	1	0	0	1	1	0	0	00 32
1	1	0	0	1	1	0	0	00 33
0	0	1	0	1	1	0	0	00 34
1	0	1	0	1	1	0	0	00 35
0	1	1	0	1	1	0	0	00 36
1	1	1	0	1	1	0	0	00 37
0	0	0	1	1	1	0	0	00 38
1	0	0	1	1	1	0	0	00 39
0	1	0	1	1	1	0	0	00 3A
1	1	0	1	1	1	0	0	00 3B
0	0	1	1	1	1	0	0	00 3C
1	0	1	1	1	1	0	0	00 3D
0	1	1	1	1	1	0	0	00 3E
1	1	1	1	1	1	0	0	00 3F

0: OFF 1: ON

SW1, SW2, SW3, SW4, SW5								Display
1	2	3	4	5	6	7	8	
0	0	0	0	0	0	1	0	00 40
1	0	0	0	0	0	1	0	00 41
0	1	0	0	0	0	1	0	00 42
1	1	0	0	0	0	1	0	00 43
0	0	1	0	0	0	1	0	00 44
1	0	1	0	0	0	1	0	00 45
0	1	1	0	0	0	1	0	00 46
1	1	1	0	0	0	1	0	00 47
0	0	0	1	0	0	1	0	00 48
1	0	0	1	0	0	1	0	00 49
0	1	0	1	0	0	1	0	00 4A
1	1	0	1	0	0	1	0	00 4B
0	0	1	1	0	0	1	0	00 4C
1	0	1	1	0	0	1	0	00 4D
0	1	1	1	0	0	1	0	00 4E
1	1	1	1	0	0	1	0	00 4F
0	0	0	0	1	0	1	0	00 50
1	0	0	0	1	0	1	0	00 51
0	1	0	0	1	0	1	0	00 52
1	1	0	0	1	0	1	0	00 53
0	0	1	0	1	0	1	0	00 54
1	0	1	0	1	0	1	0	00 55
0	1	1	0	1	0	1	0	00 56
1	1	1	0	1	0	1	0	00 57
0	0	0	1	1	0	1	0	00 58
1	0	0	1	1	0	1	0	00 59
0	1	0	1	1	0	1	0	00 5A
1	1	0	1	1	0	1	0	00 5B
0	0	1	1	1	0	1	0	00 5C
1	0	1	1	1	0	1	0	00 5D
0	1	1	1	1	0	1	0	00 5E
1	1	1	1	1	0	1	0	00 5F
0	0	0	0	0	1	1	0	00 60
1	0	0	0	0	1	1	0	00 61
0	1	0	0	0	1	1	0	00 62
1	1	0	0	0	1	1	0	00 63
0	0	1	0	0	1	1	0	00 64
1	0	1	0	0	1	1	0	00 65
0	1	1	0	0	1	1	0	00 66
1	1	1	0	0	1	1	0	00 67
0	0	0	1	0	1	1	0	00 68
1	0	0	1	0	1	1	0	00 69
0	1	0	1	0	1	1	0	00 6A
1	1	0	1	0	1	1	0	00 6B
0	0	1	1	0	1	1	0	00 6C
1	0	1	1	0	1	1	0	00 6D
0	1	1	1	0	1	1	0	00 6E
1	1	1	1	0	1	1	0	00 6F
0	0	0	0	1	1	1	0	00 70
1	0	0	0	1	1	1	0	00 71
0	1	0	0	1	1	1	0	00 72
1	1	0	0	1	1	1	0	00 73
0	0	1	0	1	1	1	0	00 74
1	0	1	0	1	1	1	0	00 75
0	1	1	0	1	1	1	0	00 76
1	1	1	0	1	1	1	0	00 77
0	0	0	1	1	1	1	0	00 78
1	0	0	1	1	1	1	0	00 79
0	1	0	1	1	1	1	0	00 7A
1	1	0	1	1	1	1	0	00 7B
0	0	1	1	1	1	1	0	00 7C
1	0	1	1	1	1	1	0	00 7D
0	1	1	1	1	1	1	0	00 7E
1	1	1	1	1	1	1	0	00 7F

Indoor unit switch setting display (Request code: 162 to 166)

0: OFF 1: ON

SW1, SW2, SW3, SW4, SW5								Display
1	2	3	4	5	6	7	8	
0	0	0	0	0	0	0	1	00 80
1	0	0	0	0	0	0	1	00 81
0	1	0	0	0	0	0	1	00 82
1	1	0	0	0	0	0	1	00 83
0	0	1	0	0	0	0	1	00 84
1	0	1	0	0	0	0	1	00 85
0	1	1	0	0	0	0	1	00 86
1	1	1	0	0	0	0	1	00 87
0	0	0	1	0	0	0	1	00 88
1	0	0	1	0	0	0	1	00 89
0	1	0	1	0	0	0	1	00 8A
1	1	0	1	0	0	0	1	00 8B
0	0	1	1	0	0	0	1	00 8C
1	0	1	1	0	0	0	1	00 8D
0	1	1	1	0	0	0	1	00 8E
1	1	1	1	0	0	0	1	00 8F
0	0	0	0	1	0	0	1	00 90
1	0	0	0	1	0	0	1	00 91
0	1	0	0	1	0	0	1	00 92
1	1	0	0	1	0	0	1	00 93
0	0	1	0	1	0	0	1	00 94
1	0	1	0	1	0	0	1	00 95
0	1	1	0	1	0	0	1	00 96
1	1	1	0	1	0	0	1	00 97
0	0	0	1	1	0	0	1	00 98
1	0	0	1	1	0	0	1	00 99
0	1	0	1	1	0	0	1	00 9A
1	1	0	1	1	0	0	1	00 9B
0	0	1	1	1	0	0	1	00 9C
1	0	1	1	1	0	0	1	00 9D
0	1	1	1	1	0	0	1	00 9E
1	1	1	1	1	0	0	1	00 9F
0	0	0	0	0	1	0	1	00 A0
1	0	0	0	0	1	0	1	00 A1
0	1	0	0	0	1	0	1	00 A2
1	1	0	0	0	1	0	1	00 A3
0	0	1	0	0	1	0	1	00 A4
1	0	1	0	0	1	0	1	00 A5
0	1	1	0	0	1	0	1	00 A6
1	1	1	0	0	1	0	1	00 A7
0	0	0	1	0	1	0	1	00 A8
1	0	0	1	0	1	0	1	00 A9
0	1	0	1	0	1	0	1	00 AA
1	1	0	1	0	1	0	1	00 AB
0	0	1	1	0	1	0	1	00 AC
1	0	1	1	0	1	0	1	00 AD
0	1	1	1	0	1	0	1	00 AE
1	1	1	1	0	1	0	1	00 AF
0	0	0	0	1	1	0	1	00 B0
1	0	0	0	1	1	0	1	00 B1
0	1	0	0	1	1	0	1	00 B2
1	1	0	0	1	1	0	1	00 B3
0	0	1	0	1	1	0	1	00 B4
1	0	1	0	1	1	0	1	00 B5
0	1	1	0	1	1	0	1	00 B6
1	1	1	0	1	1	0	1	00 B7
0	0	0	1	1	1	0	1	00 B8
1	0	0	1	1	1	0	1	00 B9
0	1	0	1	1	1	0	1	00 BA
1	1	0	1	1	1	0	1	00 BB
0	0	1	1	1	1	0	1	00 BC
1	0	1	1	1	1	0	1	00 BD
0	1	1	1	1	1	0	1	00 BE
1	1	1	1	1	1	0	1	00 BF

0: OFF 1: ON

SW1, SW2, SW3, SW4, SW5								Display
1	2	3	4	5	6	7	8	
0	0	0	0	0	0	1	1	00 C0
1	0	0	0	0	0	1	1	00 C1
0	1	0	0	0	0	1	1	00 C2
1	1	0	0	0	0	1	1	00 C3
0	0	1	0	0	0	1	1	00 C4
1	0	1	0	0	0	1	1	00 C5
0	1	1	0	0	0	1	1	00 C6
1	1	1	0	0	0	1	1	00 C7
0	0	0	1	0	0	1	1	00 C8
1	0	0	1	0	0	1	1	00 C9
0	1	0	1	0	0	1	1	00 CA
1	1	0	1	0	0	1	1	00 CB
0	0	1	1	0	0	1	1	00 CC
1	0	1	1	0	0	1	1	00 CD
0	1	1	1	0	0	1	1	00 CE
1	1	1	1	0	0	1	1	00 CF
0	0	0	0	1	0	1	1	00 D0
1	0	0	0	1	0	1	1	00 D1
0	1	0	0	1	0	1	1	00 D2
1	1	0	0	1	0	1	1	00 D3
0	0	1	0	1	0	1	1	00 D4
1	0	1	0	1	0	1	1	00 D5
0	1	1	0	1	0	1	1	00 D6
1	1	1	0	1	0	1	1	00 D7
0	0	0	1	1	0	1	1	00 D8
1	0	0	1	1	0	1	1	00 D9
0	1	0	1	1	0	1	1	00 DA
1	1	0	1	1	0	1	1	00 DB
0	0	1	1	1	0	1	1	00 DC
1	0	1	1	1	0	1	1	00 DD
0	1	1	1	1	0	1	1	00 DE
1	1	1	1	1	0	1	1	00 DF
0	0	0	0	0	1	1	1	00 E0
1	0	0	0	0	1	1	1	00 E1
0	1	0	0	0	1	1	1	00 E2
1	1	0	0	0	1	1	1	00 E3
0	0	1	0	0	1	1	1	00 E4
1	0	1	0	0	1	1	1	00 E5
0	1	1	0	0	1	1	1	00 E6
1	1	1	0	0	1	1	1	00 E7
0	0	0	1	0	1	1	1	00 E8
1	0	0	1	0	1	1	1	00 E9
0	1	0	1	0	1	1	1	00 EA
1	1	0	1	0	1	1	1	00 EB
0	0	1	1	0	1	1	1	00 EC
1	0	1	1	0	1	1	1	00 ED
0	1	1	1	0	1	1	1	00 EE
1	1	1	1	0	1	1	1	00 EF
0	0	0	0	0	1	1	1	00 F0
1	0	0	0	0	1	1	1	00 F1
0	1	0	0	0	1	1	1	00 F2
1	1	0	0	0	1	1	1	00 F3
0	0	1	0	0	1	1	1	00 F4
1	0	1	0	0	1	1	1	00 F5
0	1	1	0	0	1	1	1	00 F6
1	1	1	0	0	1	1	1	00 F7
0	0	0	1	1	1	1	1	00 F8
1	0	0	1	1	1	1	1	00 F9
0	1	0	1	1	1	1	1	00 FA
1	1	0	1	1	1	1	1	00 FB
0	0	1	1	1	1	1	1	00 FC
1	0	1	1	1	1	1	1	00 FD
0	1	1	1	1	1	1	1	00 FE
1	1	1	1	1	1	1	1	00 FF

Output signal display (Request code: 175/553)

Please refer to Table 2 on relevant wiring diagram whilst using the following.

0: OFF 1: ON

OUT								Display
1	2	3	4	5A	5B	6	7	
0	0	0	0	0	0	0	0	xx 00
1	0	0	0	0	0	0	0	xx 01
0	1	0	0	0	0	0	0	xx 02
1	1	0	0	0	0	0	0	xx 03
0	0	1	0	0	0	0	0	xx 04
1	0	1	0	0	0	0	0	xx 05
0	1	1	0	0	0	0	0	xx 06
1	1	1	0	0	0	0	0	xx 07
0	0	0	1	0	0	0	0	xx 08
1	0	0	1	0	0	0	0	xx 09
0	1	0	1	0	0	0	0	xx 0A
1	1	0	1	0	0	0	0	xx 0B
0	0	1	1	0	0	0	0	xx 0C
1	0	1	1	0	0	0	0	xx 0D
0	1	1	1	0	0	0	0	xx 0E
1	1	1	1	0	0	0	0	xx 0F
0	0	0	0	1	0	0	0	xx 10
1	0	0	0	1	0	0	0	xx 11
0	1	0	0	1	0	0	0	xx 12
1	1	0	0	1	0	0	0	xx 13
0	0	1	0	1	0	0	0	xx 14
1	0	1	0	1	0	0	0	xx 15
0	1	1	0	1	0	0	0	xx 16
1	1	1	0	1	0	0	0	xx 17
0	0	0	1	1	0	0	0	xx 18
1	0	0	1	1	0	0	0	xx 19
0	1	0	1	1	0	0	0	xx 1A
1	1	0	1	1	0	0	0	xx 1B
0	0	1	1	1	0	0	0	xx 1C
1	0	1	1	1	0	0	0	xx 1D
0	1	1	1	1	0	0	0	xx 1E
1	1	1	1	1	0	0	0	xx 1F
0	0	0	0	0	1	0	0	xx 20
1	0	0	0	0	1	0	0	xx 21
0	1	0	0	0	1	0	0	xx 22
1	1	0	0	0	1	0	0	xx 23
0	0	1	0	0	1	0	0	xx 24
1	0	1	0	0	1	0	0	xx 25
0	1	1	0	0	1	0	0	xx 26
1	1	1	0	0	1	0	0	xx 27
0	0	0	1	0	1	0	0	xx 28
1	0	0	1	0	1	0	0	xx 29
0	1	0	1	0	1	0	0	xx 2A
1	1	0	1	0	1	0	0	xx 2B
0	0	1	1	0	1	0	0	xx 2C
1	0	1	1	0	1	0	0	xx 2D
0	1	1	1	0	1	0	0	xx 2E
1	1	1	1	0	1	0	0	xx 2F
0	0	0	0	1	1	0	0	xx 30
1	0	0	0	1	1	0	0	xx 31
0	1	0	0	1	1	0	0	xx 32
1	1	0	0	1	1	0	0	xx 33
0	0	1	0	1	1	0	0	xx 34
1	0	1	0	1	1	0	0	xx 35
0	1	1	0	1	1	0	0	xx 36
1	1	1	0	1	1	0	0	xx 37
0	0	0	1	1	1	0	0	xx 38
1	0	0	1	1	1	0	0	xx 39
0	1	0	1	1	1	0	0	xx 3A
1	1	0	1	1	1	0	0	xx 3B
0	0	1	1	1	1	0	0	xx 3C
1	0	1	1	1	1	0	0	xx 3D
0	1	1	1	1	1	0	0	xx 3E
1	1	1	1	1	1	0	0	xx 3F

0: OFF 1: ON

OUT								Display
1	2	3	4	5A	5B	6	7	
0	0	0	0	0	0	1	0	xx 40
1	0	0	0	0	0	1	0	xx 41
0	1	0	0	0	0	1	0	xx 42
1	1	0	0	0	0	1	0	xx 43
0	0	1	0	0	0	1	0	xx 44
1	0	1	0	0	0	1	0	xx 45
0	1	1	0	0	0	1	0	xx 46
1	1	1	0	0	0	1	0	xx 47
0	0	0	1	0	0	1	0	xx 48
1	0	0	1	0	0	1	0	xx 49
0	1	0	1	0	0	1	0	xx 4A
1	1	0	1	0	0	1	0	xx 4B
0	0	1	1	0	0	1	0	xx 4C
1	0	1	1	0	0	1	0	xx 4D
0	1	1	1	0	0	1	0	xx 4E
1	1	1	1	0	0	1	0	xx 4F
0	0	0	0	1	0	1	0	xx 50
1	0	0	0	1	0	1	0	xx 51
0	1	0	0	1	0	1	0	xx 52
1	1	0	0	1	0	1	0	xx 53
0	0	1	0	1	0	1	0	xx 54
1	0	1	0	1	0	1	0	xx 55
0	1	1	0	1	0	1	0	xx 56
1	1	1	0	1	0	1	0	xx 57
0	0	0	1	1	0	1	0	xx 58
1	0	0	1	1	0	1	0	xx 59
0	1	0	1	1	0	1	0	xx 5A
1	1	0	1	1	0	1	0	xx 5B
0	0	1	1	1	0	1	0	xx 5C
1	0	1	1	1	0	1	0	xx 5D
0	1	1	1	1	0	1	0	xx 5E
1	1	1	1	1	0	1	0	xx 5F
0	0	0	0	0	1	1	0	xx 60
1	0	0	0	0	1	1	0	xx 61
0	1	0	0	0	1	1	0	xx 62
1	1	0	0	0	1	1	0	xx 63
0	0	1	0	0	1	1	0	xx 64
1	0	1	0	0	1	1	0	xx 65
0	1	1	0	0	1	1	0	xx 66
1	1	1	0	0	1	1	0	xx 67
0	0	0	1	0	1	1	0	xx 68
1	0	0	1	0	1	1	0	xx 69
0	1	0	1	0	1	1	0	xx 6A
1	1	0	1	0	1	1	0	xx 6B
0	0	1	1	0	1	1	0	xx 6C
1	0	1	1	0	1	1	0	xx 6D
0	1	1	1	0	1	1	0	xx 6E
1	1	1	1	0	1	1	0	xx 6F
0	0	0	0	1	1	1	0	xx 70
1	0	0	0	1	1	1	0	xx 71
0	1	0	0	1	1	1	0	xx 72
1	1	0	0	1	1	1	0	xx 73
0	0	1	0	1	1	1	0	xx 74
1	0	1	0	1	1	1	0	xx 75
0	1	1	0	1	1	1	0	xx 76
1	1	1	0	1	1	1	0	xx 77
0	0	0	1	1	1	1	0	xx 78
1	0	0	1	1	1	1	0	xx 79
0	1	0	1	1	1	1	0	xx 7A
1	1	0	1	1	1	1	0	xx 7B
0	0	1	1	1	1	1	0	xx 7C
1	0	1	1	1	1	1	0	xx 7D
0	1	1	1	1	1	1	0	xx 7E
1	1	1	1	1	1	1	0	xx 7F

Output signal display (Request code: 175/553)

Please refer to Table 2 on relevant wiring diagram whilst using the following.

0: OFF 1: ON

OUT								Display
1	2	3	4	5A	5B	6	7	
0	0	0	0	0	0	0	1	xx 80
1	0	0	0	0	0	0	1	xx 81
0	1	0	0	0	0	0	1	xx 82
1	1	0	0	0	0	0	1	xx 83
0	0	1	0	0	0	0	1	xx 84
1	0	1	0	0	0	0	1	xx 85
0	1	1	0	0	0	0	1	xx 86
1	1	1	0	0	0	0	1	xx 87
0	0	0	1	0	0	0	1	xx 88
1	0	0	1	0	0	0	1	xx 89
0	1	0	1	0	0	0	1	xx 8A
1	1	0	1	0	0	0	1	xx 8B
0	0	1	1	0	0	0	1	xx 8C
1	0	1	1	0	0	0	1	xx 8D
0	1	1	1	0	0	0	1	xx 8E
1	1	1	1	0	0	0	1	xx 8F
0	0	0	0	1	0	0	1	xx 90
1	0	0	0	1	0	0	1	xx 91
0	1	0	0	1	0	0	1	xx 92
1	1	0	0	1	0	0	1	xx 93
0	0	1	0	1	0	0	1	xx 94
1	0	1	0	1	0	0	1	xx 95
0	1	1	0	1	0	0	1	xx 96
1	1	1	0	1	0	0	1	xx 97
0	0	0	1	1	0	0	1	xx 98
1	0	0	1	1	0	0	1	xx 99
0	1	0	1	1	0	0	1	xx 9A
1	1	0	1	1	0	0	1	xx 9B
0	0	1	1	1	0	0	1	xx 9C
1	0	1	1	1	0	0	1	xx 9D
0	1	1	1	1	0	0	1	xx 9E
1	1	1	1	1	0	0	1	xx 9F
0	0	0	0	0	1	0	1	xx A0
1	0	0	0	0	1	0	1	xx A1
0	1	0	0	0	1	0	1	xx A2
1	1	0	0	0	1	0	1	xx A3
0	0	1	0	0	1	0	1	xx A4
1	0	1	0	0	1	0	1	xx A5
0	1	1	0	0	1	0	1	xx A6
1	1	1	0	0	1	0	1	xx A7
0	0	0	1	0	1	0	1	xx A8
1	0	0	1	0	1	0	1	xx A9
0	1	0	1	0	1	0	1	xx AA
1	1	0	1	0	1	0	1	xx AB
0	0	1	1	0	1	0	1	xx AC
1	0	1	1	0	1	0	1	xx AD
0	1	1	1	0	1	0	1	xx AE
1	1	1	1	0	1	0	1	xx AF
0	0	0	0	1	1	0	1	xx B0
1	0	0	0	1	1	0	1	xx B1
0	1	0	0	1	1	0	1	xx B2
1	1	0	0	1	1	0	1	xx B3
0	0	1	0	1	1	0	1	xx B4
1	0	1	0	1	1	0	1	xx B5
0	1	1	0	1	1	0	1	xx B6
1	1	1	0	1	1	0	1	xx B7
0	0	0	1	1	1	0	1	xx B8
1	0	0	1	1	1	0	1	xx B9
0	1	0	1	1	1	0	1	xx BA
1	1	0	1	1	1	0	1	xx BB
0	0	1	1	1	1	0	1	xx BC
1	0	1	1	1	1	0	1	xx BD
0	1	1	1	1	1	0	1	xx BE
1	1	1	1	1	1	0	1	xx BF

0: OFF 1: ON

OUT								Display
1	2	3	4	5A	5B	6	7	
0	0	0	0	0	0	1	1	xx C0
1	0	0	0	0	0	1	1	xx C1
0	1	0	0	0	0	1	1	xx C2
1	1	0	0	0	0	1	1	xx C3
0	0	1	0	0	0	1	1	xx C4
1	0	1	0	0	0	1	1	xx C5
0	1	1	0	0	0	1	1	xx C6
1	1	1	0	0	0	1	1	xx C7
0	0	0	1	0	0	1	1	xx C8
1	0	0	1	0	0	1	1	xx C9
0	1	0	1	0	0	1	1	xx CA
1	1	0	1	0	0	1	1	xx CB
0	0	1	1	0	0	1	1	xx CC
1	0	1	1	0	0	1	1	xx CD
0	1	1	1	0	0	1	1	xx CE
1	1	1	1	0	0	1	1	xx CF
0	0	0	0	1	0	1	1	xx D0
1	0	0	0	1	0	1	1	xx D1
0	1	0	0	1	0	1	1	xx D2
1	1	0	0	1	0	1	1	xx D3
0	0	1	0	1	0	1	1	xx D4
1	0	1	0	1	0	1	1	xx D5
0	1	1	0	1	0	1	1	xx D6
1	1	1	0	1	0	1	1	xx D7
0	0	0	1	1	0	1	1	xx D8
1	0	0	1	1	0	1	1	xx D9
0	1	0	1	1	0	1	1	xx DA
1	1	0	1	1	0	1	1	xx DB
0	0	1	1	1	0	1	1	xx DC
1	0	1	1	1	0	1	1	xx DD
0	1	1	1	1	0	1	1	xx DE
1	1	1	1	1	0	1	1	xx DF
0	0	0	0	0	1	1	1	xx E0
1	0	0	0	0	1	1	1	xx E1
0	1	0	0	0	1	1	1	xx E2
1	1	0	0	0	1	1	1	xx E3
0	0	1	0	0	1	1	1	xx E4
1	0	1	0	0	1	1	1	xx E5
0	1	1	0	0	1	1	1	xx E6
1	1	1	0	0	1	1	1	xx E7
0	0	0	1	0	1	1	1	xx E8
1	0	0	1	0	1	1	1	xx E9
0	1	0	1	0	1	1	1	xx EA
1	1	0	1	0	1	1	1	xx EB
0	0	1	1	0	1	1	1	xx EC
1	0	1	1	0	1	1	1	xx ED
0	1	1	1	0	1	1	1	xx EE
1	1	1	1	0	1	1	1	xx EF
0	0	0	0	1	1	1	1	xx F0
1	0	0	0	1	1	1	1	xx F1
0	1	0	0	1	1	1	1	xx F2
1	1	0	0	1	1	1	1	xx F3
0	0	1	0	1	1	1	1	xx F4
1	0	1	0	1	1	1	1	xx F5
0	1	1	0	1	1	1	1	xx F6
1	1	1	0	1	1	1	1	xx F7
0	0	0	1	1	1	1	1	xx F8
1	0	0	1	1	1	1	1	xx F9
0	1	0	1	1	1	1	1	xx FA
1	1	0	1	1	1	1	1	xx FB
0	0	1	1	1	1	1	1	xx FC
1	0	1	1	1	1	1	1	xx FD
0	1	1	1	1	1	1	1	xx FE
1	1	1	1	1	1	1	1	xx FF

Output signal display (Request code: 175/553)

Please refer to Table 2 on relevant wiring diagram whilst using the following.

0: OFF 1: ON

OUT								Display
8*	9	10	11	12	13	14	15	
0	0	0	0	0	0	0	0	00 xx
1	0	0	0	0	0	0	0	01 xx
0	1	0	0	0	0	0	0	02 xx
1	1	0	0	0	0	0	0	03 xx
0	0	1	0	0	0	0	0	04 xx
1	0	1	0	0	0	0	0	05 xx
0	1	1	0	0	0	0	0	06 xx
1	1	1	0	0	0	0	0	07 xx
0	0	0	1	0	0	0	0	08 xx
1	0	0	1	0	0	0	0	09 xx
0	1	0	1	0	0	0	0	0A xx
1	1	0	1	0	0	0	0	0B xx
0	0	1	1	0	0	0	0	0C xx
1	0	1	1	0	0	0	0	0D xx
0	1	1	1	0	0	0	0	0E xx
1	1	1	1	0	0	0	0	0F xx
0	0	0	0	1	0	0	0	10 xx
1	0	0	0	1	0	0	0	11 xx
0	1	0	0	1	0	0	0	12 xx
1	1	0	0	1	0	0	0	13 xx
0	0	1	0	1	0	0	0	14 xx
1	0	1	0	1	0	0	0	15 xx
0	1	1	0	1	0	0	0	16 xx
1	1	1	0	1	0	0	0	17 xx
0	0	0	1	1	0	0	0	18 xx
1	0	0	1	1	0	0	0	19 xx
0	1	0	1	1	0	0	0	1A xx
1	1	0	1	1	0	0	0	1B xx
0	0	1	1	1	0	0	0	1C xx
1	0	1	1	1	0	0	0	1D xx
0	1	1	1	1	0	0	0	1E xx
1	1	1	1	1	0	0	0	1F xx
0	0	0	0	0	1	0	0	20 xx
1	0	0	0	0	1	0	0	21 xx
0	1	0	0	0	1	0	0	22 xx
1	1	0	0	0	1	0	0	23 xx
0	0	1	0	0	1	0	0	24 xx
1	0	1	0	0	1	0	0	25 xx
0	1	1	0	0	1	0	0	26 xx
1	1	1	0	0	1	0	0	27 xx
0	0	0	1	0	1	0	0	28 xx
1	0	0	1	0	1	0	0	29 xx
0	1	0	1	0	1	0	0	2A xx
1	1	0	1	0	1	0	0	2B xx
0	0	1	1	0	1	0	0	2C xx
1	0	1	1	0	1	0	0	2D xx
0	1	1	1	0	1	0	0	2E xx
1	1	1	1	0	1	0	0	2F xx
0	0	0	0	1	1	0	0	30 xx
1	0	0	0	1	1	0	0	31 xx
0	1	0	0	1	1	0	0	32 xx
1	1	0	0	1	1	0	0	33 xx
0	0	1	0	1	1	0	0	34 xx
1	0	1	0	1	1	0	0	35 xx
0	1	1	0	1	1	0	0	36 xx
1	1	1	0	1	1	0	0	37 xx
0	0	0	1	1	1	0	0	38 xx
1	0	0	1	1	1	0	0	39 xx
0	1	0	1	1	1	0	0	3A xx
1	1	0	1	1	1	0	0	3B xx
0	0	1	1	1	1	0	0	3C xx
1	0	1	1	1	1	0	0	3D xx
0	1	1	1	1	1	0	0	3E xx
1	1	1	1	1	1	0	0	3F xx

* Displayed only when the request code is 533.

OUT								Display
8	9	10	11	12	13	14	15	
0	0	0	0	0	0	1	0	40 xx
1	0	0	0	0	0	1	0	41 xx
0	1	0	0	0	0	1	0	42 xx
1	1	0	0	0	0	1	0	43 xx
0	0	1	0	0	0	1	0	44 xx
1	0	1	0	0	0	1	0	45 xx
0	1	1	0	0	0	1	0	46 xx
1	1	1	0	0	0	1	0	47 xx
0	0	0	1	0	0	1	0	48 xx
1	0	0	1	0	0	1	0	49 xx
0	1	0	1	0	0	1	0	4A xx
1	1	0	1	0	0	1	0	4B xx
0	0	1	1	0	0	1	0	4C xx
1	0	1	1	0	0	1	0	4D xx
0	1	1	1	0	0	1	0	4E xx
1	1	1	1	0	0	1	0	4F xx
0	0	0	0	1	0	1	0	50 xx
1	0	0	0	1	0	1	0	51 xx
0	1	0	0	1	0	1	0	52 xx
1	1	0	0	1	0	1	0	53 xx
0	0	1	0	1	0	1	0	54 xx
1	0	1	0	1	0	1	0	55 xx
0	1	1	0	1	0	1	0	56 xx
1	1	1	0	1	0	1	0	57 xx
0	0	0	1	1	0	1	0	58 xx
1	0	0	1	1	0	1	0	59 xx
0	1	0	1	1	0	1	0	5A xx
1	1	0	1	1	0	1	0	5B xx
0	0	1	1	1	0	1	0	5C xx
1	0	1	1	1	0	1	0	5D xx
0	1	1	1	1	0	1	0	5E xx
1	1	1	1	1	0	1	0	5F xx
0	0	0	0	0	1	1	0	60 xx
1	0	0	0	0	1	1	0	61 xx
0	1	0	0	0	1	1	0	62 xx
1	1	0	0	0	1	1	0	63 xx
0	0	1	0	0	1	1	0	64 xx
1	0	1	0	0	1	1	0	65 xx
0	1	1	0	0	1	1	0	66 xx
1	1	1	0	0	1	1	0	67 xx
0	0	0	1	0	1	1	0	68 xx
1	0	0	1	0	1	1	0	69 xx
0	1	0	1	0	1	1	0	6A xx
1	1	0	1	0	1	1	0	6B xx
0	0	1	1	0	1	1	0	6C xx
1	0	1	1	0	1	1	0	6D xx
0	1	1	1	0	1	1	0	6E xx
1	1	1	1	0	1	1	0	6F xx
0	0	0	0	1	1	1	0	70 xx
1	0	0	0	1	1	1	0	71 xx
0	1	0	0	1	1	1	0	72 xx
1	1	0	0	1	1	1	0	73 xx
0	0	1	0	1	1	1	0	74 xx
1	0	1	0	1	1	1	0	75 xx
0	1	1	0	1	1	1	0	76 xx
1	1	1	0	1	1	1	0	77 xx
0	0	0	1	1	1	1	0	78 xx
1	0	0	1	1	1	1	0	79 xx
0	1	0	1	1	1	1	0	7A xx
1	1	0	1	1	1	1	0	7B xx
0	0	1	1	1	1	1	0	7C xx
1	0	1	1	1	1	1	0	7D xx
0	1	1	1	1	1	1	0	7E xx
1	1	1	1	1	1	1	0	7F xx

Mixing valve state

OUT		Mixing valve state
5A	5B	
0	0	Stop
0	1	Stop
1	0	Open
1	1	Close

Input signal display (Request code: 176/554)

Please refer to Table 1 on relevant wiring diagram whilst using the following.

0: OFF (open) 1: ON (short)

IN								Display
1	2	3	4	5	6	7	8	
0	0	0	0	0	0	0	0	00 00
1	0	0	0	0	0	0	0	00 01
0	1	0	0	0	0	0	0	00 02
1	1	0	0	0	0	0	0	00 03
0	0	1	0	0	0	0	0	00 04
1	0	1	0	0	0	0	0	00 05
0	1	1	0	0	0	0	0	00 06
1	1	1	0	0	0	0	0	00 07
0	0	0	1	0	0	0	0	00 08
1	0	0	1	0	0	0	0	00 09
0	1	0	1	0	0	0	0	00 0A
1	1	0	1	0	0	0	0	00 0B
0	0	1	1	0	0	0	0	00 0C
1	0	1	1	0	0	0	0	00 0D
0	1	1	1	0	0	0	0	00 0E
1	1	1	1	0	0	0	0	00 0F
0	0	0	0	1	0	0	0	00 10
1	0	0	0	1	0	0	0	00 11
0	1	0	0	1	0	0	0	00 12
1	1	0	0	1	0	0	0	00 13
0	0	1	0	1	0	0	0	00 14
1	0	1	0	1	0	0	0	00 15
0	1	1	0	1	0	0	0	00 16
1	1	1	0	1	0	0	0	00 17
0	0	0	1	1	0	0	0	00 18
1	0	0	1	1	0	0	0	00 19
0	1	0	1	1	0	0	0	00 1A
1	1	0	1	1	0	0	0	00 1B
0	0	1	1	1	0	0	0	00 1C
1	0	1	1	1	0	0	0	00 1D
0	1	1	1	1	0	0	0	00 1E
1	1	1	1	1	0	0	0	00 1F
0	0	0	0	0	1	0	0	00 20
1	0	0	0	0	1	0	0	00 21
0	1	0	0	0	1	0	0	00 22
1	1	0	0	0	1	0	0	00 23
0	0	1	0	0	1	0	0	00 24
1	0	1	0	0	1	0	0	00 25
0	1	1	0	0	1	0	0	00 26
1	1	1	0	0	1	0	0	00 27
0	0	0	1	0	1	0	0	00 28
1	0	0	1	0	1	0	0	00 29
0	1	0	1	0	1	0	0	00 2A
1	1	0	1	0	1	0	0	00 2B
0	0	1	1	0	1	0	0	00 2C
1	0	1	1	0	1	0	0	00 2D
0	1	1	1	0	1	0	0	00 2E
1	1	1	1	0	1	0	0	00 2F
0	0	0	0	1	1	0	0	00 30
1	0	0	0	1	1	0	0	00 31
0	1	0	0	1	1	0	0	00 32
1	1	0	0	1	1	0	0	00 33
0	0	1	0	1	1	0	0	00 34
1	0	1	0	1	1	0	0	00 35
0	1	1	0	1	1	0	0	00 36
1	1	1	0	1	1	0	0	00 37
0	0	0	1	1	1	0	0	00 38
1	0	0	1	1	1	0	0	00 39
0	1	0	1	1	1	0	0	00 3A
1	1	0	1	1	1	0	0	00 3B
0	0	1	1	1	1	0	0	00 3C
1	0	1	1	1	1	0	0	00 3D
0	1	1	1	1	1	0	0	00 3E
1	1	1	1	1	1	0	0	00 3F

0: OFF (open) 1: ON (short)

IN								Display
1	2	3	4	5	6	7	8	
0	0	0	0	0	0	1	0	00 40
1	0	0	0	0	0	1	0	00 41
0	1	0	0	0	0	1	0	00 42
1	1	0	0	0	0	1	0	00 43
0	0	1	0	0	0	1	0	00 44
1	0	1	0	0	0	1	0	00 45
0	1	1	0	0	0	1	0	00 46
1	1	1	0	0	0	1	0	00 47
0	0	0	1	0	0	1	0	00 48
1	0	0	1	0	0	1	0	00 49
0	1	0	1	0	0	1	0	00 4A
1	1	0	1	0	0	1	0	00 4B
0	0	1	1	0	0	1	0	00 4C
1	0	1	1	0	0	1	0	00 4D
0	1	1	1	0	0	1	0	00 4E
1	1	1	1	0	0	1	0	00 4F
0	0	0	0	1	0	1	0	00 50
1	0	0	0	1	0	1	0	00 51
0	1	0	0	1	0	1	0	00 52
1	1	0	0	1	0	1	0	00 53
0	0	1	0	1	0	1	0	00 54
1	0	1	0	1	0	1	0	00 55
0	1	1	0	1	0	1	0	00 56
1	1	1	0	1	0	1	0	00 57
0	0	0	1	1	0	1	0	00 58
1	0	0	1	1	0	1	0	00 59
0	1	0	1	1	0	1	0	00 5A
1	1	0	1	1	0	1	0	00 5B
0	0	1	1	1	0	1	0	00 5C
1	0	1	1	1	0	1	0	00 5D
0	1	1	1	1	0	1	0	00 5E
1	1	1	1	1	0	1	0	00 5F
0	0	0	0	0	1	1	0	00 60
1	0	0	0	0	1	1	0	00 61
0	1	0	0	0	1	1	0	00 62
1	1	0	0	0	1	1	0	00 63
0	0	1	0	0	1	1	0	00 64
1	0	1	0	0	1	1	0	00 65
0	1	1	0	0	1	1	0	00 66
1	1	1	0	0	1	1	0	00 67
0	0	0	1	0	1	1	0	00 68
1	0	0	1	0	1	1	0	00 69
0	1	0	1	0	1	1	0	00 6A
1	1	0	1	0	1	1	0	00 6B
0	0	1	1	0	1	1	0	00 6C
1	0	1	1	0	1	1	0	00 6D
0	1	1	1	0	1	1	0	00 6E
1	1	1	1	0	1	1	0	00 6F
0	0	0	0	1	1	1	0	00 70
1	0	0	0	1	1	1	0	00 71
0	1	0	0	1	1	1	0	00 72
1	1	0	0	1	1	1	0	00 73
0	0	1	0	1	1	1	0	00 74
1	0	1	0	1	1	1	0	00 75
0	1	1	0	1	1	1	0	00 76
1	1	1	0	1	1	1	0	00 77
0	0	0	1	1	1	1	0	00 78
1	0	0	1	1	1	1	0	00 79
0	1	0	1	1	1	1	0	00 7A
1	1	0	1	1	1	1	0	00 7B
0	0	1	1	1	1	1	0	00 7C
1	0	1	1	1	1	1	0	00 7D
0	1	1	1	1	1	1	0	00 7E
1	1	1	1	1	1	1	0	00 7F

■ Indoor unit only operation

In indoor unit only operation, operation without connecting outdoor unit is possible.
During Indoor unit only operation, the main control has control functions.

<Heater>

Heating for DHW and space heating is provided by the heater.

- Activating indoor unit only operation mode

To activate indoor unit only operation, see the following:

1. Switch OFF the breaker for the outdoor unit (or both breakers if hydrobox is powered independently).
2. Change DIP switch SW4-4 and SW4-5 to ON.
3. Switch ON the breaker(s).
4. Indoor unit only operation is now activated.

- Deactivating indoor unit only operation mode

To deactivate indoor unit only operation, see the following:

1. Switch OFF the breaker for the outdoor unit (or both breakers if hydrobox is powered independently).
2. Change DIP switch SW4-4 and SW4-5 to OFF.
3. Switch ON the breaker(s).
4. Indoor unit only operation is now deactivated.

<Boiler>

Heating for space heating is provided by the boiler.

- Activating indoor unit only operation mode

To activate indoor unit only operation, see the following:

1. Switch OFF the breaker for the outdoor unit (or both breakers if hydrobox is powered independently).
2. Change DIP switch SW4-4 and SW4-6 to ON.
3. Switch ON the breaker(s).
4. Indoor unit only operation is now activated.

- Deactivating indoor unit only operation mode

To deactivate indoor unit only operation, see the following:

1. Switch OFF the breaker for the outdoor unit (or both breakers if hydrobox is powered independently).
2. Change DIP switch SW4-4 and SW4-6 to OFF.
3. Switch ON the breaker(s).
4. Indoor unit only operation is now deactivated.

■ Emergency operation

In emergency operation, operation without connecting outdoor unit and main remote controller is possible.

During Emergency operation, the main control has NO control functions.

Space heating flow temp. is restarted 40°C and DHW tank temp. is restricted 50°C. *1

<Heater>

Heating for DHW and space heating is provided by the heater.

- Activating emergency operation mode

To activate emergency operation, see the following:

1. Switch OFF the breaker for the outdoor unit (or both breakers if hydrobox is powered independently).
2. Change DIP switch SW4-5 to ON.
3. Switch ON the breaker(s).
4. Emergency operation is now activated.

- Deactivating emergency operation mode

To deactivate emergency operation, see the following:

1. Switch OFF the breaker for the outdoor unit (or both breakers if hydrobox is powered independently).
2. Change DIP switch SW4-5 to OFF.
3. Switch ON the breaker(s).
4. Emergency operation is now deactivated.

<Boiler>

Heating for space heating is provided by the boiler.

- Activating emergency operation mode

To activate emergency operation, see the following:

1. Switch OFF the breaker for the outdoor unit (or both breakers if hydrobox is powered independently).
2. Change DIP switch SW4-6 to ON.
3. Switch ON the breaker(s).
4. Emergency operation is now activated.

- Deactivating emergency operation mode

To deactivate emergency operation, see the following:

1. Switch OFF the breaker for the outdoor unit (or both breakers if hydrobox is powered independently).
2. Change DIP switch SW4-6 to OFF.
3. Switch ON the breaker(s).
4. Emergency operation is now deactivated.

⚠ WARNING

Do not attempt to change the DIP switches whilst the breaker(s) are ON as this could result in electric shock.

	Indoor unit only operation
Indoor unit	Necessary
Heat pump	Not necessary
Main remote controller	Necessary
DIP switch setting	Electric heater SW4-4 ON, SW4-5 ON Boiler SW4-4 ON, SW4-6 ON
Setting range for flow temp.	20 to 60°C Selectable
Setting range for tank temp.	40 to 60°C Selectable

	Emergency operation
Indoor unit	Necessary
Heat pump	Not necessary
Main remote controller	Not necessary
DIP switch setting	Electric heater SW4-5 ON Boiler SW4-6 ON
Setting range for flow temp.	Fixed at 40°C
Setting range for tank temp.	Fixed at 50°C *1

*1 Default setting is 50°C. Once system has started running, emergency operation runs at the latest set temp.

10-1. Troubleshooting

<Summary of self diagnosis based on check codes and Service Procedures>

Present and past check codes are logged, and they can be displayed on the main remote controller or control board of the outdoor unit. Please refer to the table below and subsequent explanations to diagnose and remedy typical problems that may occur in the field.

Unit Condition	Check code	Action
Reoccurring problem	Displayed	Use table "10-4. Self diagnosis and action" to identify fault and correct.
	Not Displayed	Use table "10-5. Troubleshooting by inferior phenomena" to identify fault and correct.
Non reoccurring problem	Logged	1. Check temporary causes of defects such as the operation of safety devices on the refrigerant/water circuit including compressor, poor wiring, electrical noise, etc. Re-check the symptom and the installation environment, refrigerant amount (Split systems only), weather conditions at time of fault, etc. 2. Reset check code logs, Service the unit and restart system.
	Not Logged	1. Recheck the abnormal symptom. 2. Identify cause of problem and take corrective action according to Table "10-5. Troubleshooting by inferior phenomena". 3. If no obvious problem can be found, continue to operate the unit.

Note:

Electrical components should only be replaced as a final option. Please follow instructions in "10-4. Self diagnosis and action" and "10-5. Troubleshooting by inferior phenomena" fully before resorting to replacing parts.

10-2. Test Run

Before a test run

- After installation of outdoor unit, pipework and electrical wiring, recheck that there is no water leakage, loosened connections or miswiring.
- Measure impedance between the ground and the power supply terminal block (L,N) on the outdoor and indoor units with suitable (500 V) ohmmeter. Resistance should be $\geq 1.0 \text{ M}\Omega$.
- Read the Installation and Operation Manuals fully especially the safety requirements before carrying out any test runs.

10-3. Malfunction diagnosis method by main remote controller

If a malfunction occurs during start up or operation, the check code screen may be displayed on the main remote controller.

The check code screen shows the following; code, unit, ref. address, and telephone number of installer (only if previously entered by the installer)

Please note in the case of some malfunctions an check code is not generated, please refer to table "10-5. Troubleshooting by inferior phenomena" for more details.

To reset

1. To reset the main remote controller press F4 button (Reset).
2. Then press F3 (Yes) to confirm.

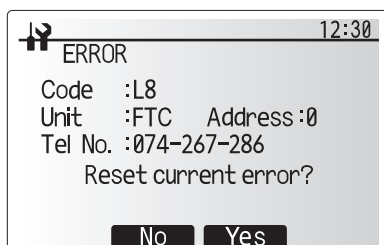
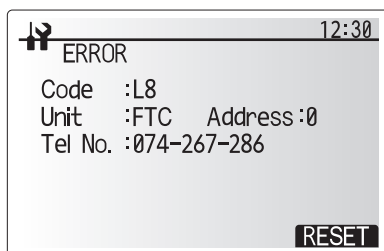

10-4. Self diagnosis and action

Check if DIP SW is set correctly. (Refer to "6-6. DIP switch functions".)

Check code	Title and display conditions	Possible Cause	Diagnosis and action
L3	<p>Circulation water temperature overheat protection <DHW/Heating/Cooling/LP/FS/OS> Check code displayed when THW1 detects a temp. $\geq 80^{\circ}\text{C}$ for 10 consecutive seconds or THW2 detects a temp. $\geq 80^{\circ}\text{C}$ for 10 consecutive seconds.</p> <p>DHW : Domestic hot water mode Heating : Heating mode Cooling : Cooling mode LP : Legionella prevention mode FS : Freeze stat OS : Operation stop TH1A/B : Room temperature thermistor TH2 : Refrigerant liquid temperature thermistor THW1 : Flow water temperature thermistor THW2 : Return water temperature thermistor THW5A/B : DHW tank water temperature thermistor THW6 : Zone1 flow temperature thermistor THW7 : Zone1 return temperature thermistor THW8 : Zone2 flow temperature thermistor THW9 : Zone2 return temperature thermistor THWB1 : Boiler flow temperature thermistor</p>	<ol style="list-style-type: none"> Insufficient system head Reduced flow in primary water circuit Due to 1 or more of the following; Faulty pump, insufficient air purge, blocked strainer, leak in water circuit Valve operation fault 2-way valve (local supply) actuator fault 3-way valve (local supply) actuator fault Booster heater relay (BHC1, BHC2, BHCP) operating fault Power supply voltage increase THW1 or THW5B has become detached from its holder. THW1 or THW2 fault FTC board failure 	<ol style="list-style-type: none"> Refer to table in "10-6. Checking Component Parts' Function" to determine if system pump meets requirements. If more head required either add a pump of the same size or replace existing pump with capacity model. See "11. DISASSEMBLY PROCEDURE" for how to replace pump. Check circulation pump (See "10-6. Checking Component Parts' Function" for how to check). Open purge valve to remove trapped air. Check the strainer for blockages. Check the primary water circuit for leaks. Check that the flow amount is within the recommended range. Check valves on primary water circuit are installed level. Electrically test to determine fault. 1) Electrically test to determine fault. 2) Operate 3-way valve manually using the main remote controller. (Refer to <Manual operation> in "9-4. Service Menu".) 3) Replace 3-way valve. Electrically test the relays (BHC1, BHC2, BHCP) to determine fault. See "10-6. Checking Component Parts' Function" for how to check. Check the supply voltage. Visually inspect location and reattach as necessary. Check resistance of thermistor against table in "10-6. Checking Component Parts' Function". Compare FTC detected temperature to hand held detector. Replace board.
L4	<p>Tank water temperature overheat protection <DHW/Heating/Cooling/LP/FS/OS> Check code display when THW5B detects a temp. $\geq 75^{\circ}\text{C}$ for 10 consecutive seconds.</p>	<ol style="list-style-type: none"> 3-way valve (local supply) actuator fault Immersion heater relay (IHC) operating fault THW5B fault FTC board failure 	<ol style="list-style-type: none"> 1) Electrically test to determine fault. 2) Operate 3-way valve manually using the main remote controller. (Refer to <Manual operation> in "9-4. Service Menu".) 3) Replace 3-way valve. Check immersion heater relay (IHC). Check resistance of thermistor against table in "10-6. Checking Component Parts' Function". Compare FTC detected temperature to hand held detector. Replace board.

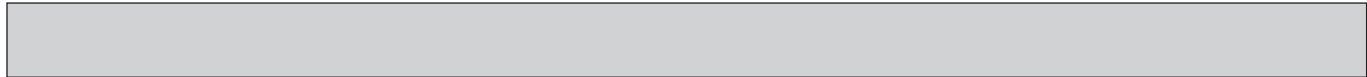

Check code	Title and display conditions	Possible Cause	Diagnosis and action																																																										
P1/P2/L5/LD	<p>Indoor unit temperature thermistor failure Note: The thermistors subject to failure can be checked in "Request code: 567" in "Running information."</p> <p><DHW/Heating/Cooling/LP/FS/OS> Check code displayed when thermistor is at open or short (see table).</p> <p><u>Exceptions</u> Check code will not be displayed for TH2; During defrost and for 10 minutes after defrost operation.</p>	<ol style="list-style-type: none"> Connector/terminal wire has become detached or loose wiring. Thermistor fault FTC board failure The thermistor on the wireless remote controller or the main remote controller may be defective. (when Room temp. is chosen for the Heating operation and when Main remote controller or Room RC 1-8 is chosen for the Room Sensor setting in the Initial setting) Incorrect setting of the DIP switch(es) 	<ol style="list-style-type: none"> Visually check the terminals and connections and reattaches appropriate. Check resistance of thermistor against table in "10-6. Checking Component Parts' Function". Compare FTC detected temperature to hand held detector. Replace board. Replace wireless remote controller or main remote controller. Check the DIP switch setting(s). 																																																										
				<table border="1"> <thead> <tr> <th rowspan="2">Check code</th> <th colspan="2">Thermistor</th> <th rowspan="2">Open detection</th> <th rowspan="2">Short detection</th> </tr> <tr> <th>Symbol</th> <th>Name</th> </tr> </thead> <tbody> <tr> <td>P1</td> <td>TH1A/TH1B</td> <td>Room temperature thermistor</td> <td>-39°C or below</td> <td>88.5°C or above</td> </tr> <tr> <td>P2</td> <td>TH2</td> <td>Liquid temperature thermistor</td> <td>-39°C or below</td> <td>88.5°C or above</td> </tr> <tr> <td rowspan="7">L5</td> <td>THW1</td> <td>Flow water temperature thermistor</td> <td>-39°C or below</td> <td>88.5°C or above</td> </tr> <tr> <td>THW2</td> <td>Return water temperature thermistor</td> <td>-39°C or below</td> <td>88.5°C or above</td> </tr> <tr> <td>THW5A</td> <td>DHW tank water temperature thermistor (upper)</td> <td>-39°C or below</td> <td>88.5°C or above</td> </tr> <tr> <td>THW5B</td> <td>DHW tank water temperature thermistor (lower)</td> <td>-39°C or below</td> <td>88.5°C or above</td> </tr> <tr> <td>THW6</td> <td>Zone1 flow temperature thermistor</td> <td>-39°C or below</td> <td>88.5°C or above</td> </tr> <tr> <td>THW7</td> <td>Zone1 return temperature thermistor</td> <td>-39°C or below</td> <td>88.5°C or above</td> </tr> <tr> <td>THW8</td> <td>Zone2 flow temperature thermistor</td> <td>-39°C or below</td> <td>88.5°C or above</td> </tr> <tr> <td rowspan="2">LD</td> <td>THW9</td> <td>Zone2 return temperature thermistor</td> <td>-39°C or below</td> <td>88.5°C or above</td> </tr> <tr> <td>THWB1</td> <td>Boiler flow temperature thermistor</td> <td>-40°C or below</td> <td>140°C or above</td> </tr> </tbody> </table>			Check code	Thermistor		Open detection	Short detection	Symbol	Name	P1	TH1A/TH1B	Room temperature thermistor	-39°C or below	88.5°C or above	P2	TH2	Liquid temperature thermistor	-39°C or below	88.5°C or above	L5	THW1	Flow water temperature thermistor	-39°C or below	88.5°C or above	THW2	Return water temperature thermistor	-39°C or below	88.5°C or above	THW5A	DHW tank water temperature thermistor (upper)	-39°C or below	88.5°C or above	THW5B	DHW tank water temperature thermistor (lower)	-39°C or below	88.5°C or above	THW6	Zone1 flow temperature thermistor	-39°C or below	88.5°C or above	THW7	Zone1 return temperature thermistor	-39°C or below	88.5°C or above	THW8	Zone2 flow temperature thermistor	-39°C or below	88.5°C or above	LD	THW9	Zone2 return temperature thermistor	-39°C or below	88.5°C or above	THWB1	Boiler flow temperature thermistor	-40°C or below	140°C or above
				Check code	Thermistor			Open detection	Short detection																																																				
					Symbol	Name																																																							
				P1	TH1A/TH1B	Room temperature thermistor	-39°C or below	88.5°C or above																																																					
				P2	TH2	Liquid temperature thermistor	-39°C or below	88.5°C or above																																																					
				L5	THW1	Flow water temperature thermistor	-39°C or below	88.5°C or above																																																					
					THW2	Return water temperature thermistor	-39°C or below	88.5°C or above																																																					
					THW5A	DHW tank water temperature thermistor (upper)	-39°C or below	88.5°C or above																																																					
					THW5B	DHW tank water temperature thermistor (lower)	-39°C or below	88.5°C or above																																																					
THW6	Zone1 flow temperature thermistor	-39°C or below	88.5°C or above																																																										
THW7	Zone1 return temperature thermistor	-39°C or below	88.5°C or above																																																										
THW8	Zone2 flow temperature thermistor	-39°C or below	88.5°C or above																																																										
LD	THW9	Zone2 return temperature thermistor	-39°C or below	88.5°C or above																																																									
	THWB1	Boiler flow temperature thermistor	-40°C or below	140°C or above																																																									
L6	<p>Circulation water freeze protection <DHW/Heating/Cooling/LP/FS/OS> Check code displayed when THW1 detects a temp. ≤ 1°C for 10 consecutive seconds or THW2 detects a temp. ≤ 3°C for 10 consecutive seconds.</p> <p><u>Exception</u> Check code will not be displayed if, FS function is disabled, For 10 minutes after water circulation pump1 is switched on.</p>	<ol style="list-style-type: none"> Insufficient system head Reduced flow in primary water circuit. Due to 1 or more of the following; Faulty pump, insufficient air purge, blocked strainer, leak in water circuit Valve operation fault 2-way valve (local supply) actuator fault 3-way valve (local supply) actuator fault THW1 has become detached from its holder. THW1 or THW2 fault FTC board failure 	<ol style="list-style-type: none"> Refer to table in "10-6. Checking Component Parts' Function" to determine if system pump meets requirements. If more head required either add a pump of the same size or replace existing pump with capacity model. See "11. DISASSEMBLY PROCEDURE" for how to replace pump. Check circulation pump (See "10-6. Checking Component Parts' Function" for how to check). Open purge valve to remove trapped air. Check the strainer for blockages. Check the primary water circuit for leaks. Check that the flow amount is within the recommended range. Check valves on primary water circuit are installed level. Electrically test to determine fault. 1) Electrically test to determine fault. 2) Operate 3-way valve manually using the main remote controller. (Refer to <Manual operation> in "9-4. Service Menu".) 3) Replace 3-way valve. Visually inspect location and reattach as necessary. Check resistance of thermistor against table in "10-6. Checking Component Parts' Function". Compare FTC detected temperature to hand held detector. Replace board. 																																																										

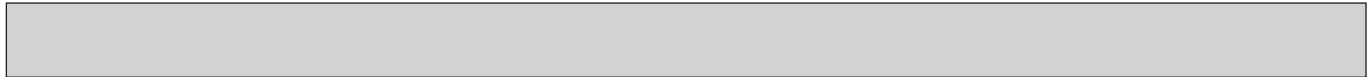

Check code	Title and display conditions	Possible Cause	Diagnosis and action
L8	Heating operation error Note: "3" is displayed in "Request code: 567" in "Running information". <Heating/FS> If a), b) and c) occur, L8 is displayed; a) No change on THW1 and THW5B (under 1°C for 20 minutes from unit starts operation) b) No change on THW1 (under 1°C for 10 minutes from booster heater starts operation) c) THW1-THW2 < -5°C (for 10 minutes continuously)	1. THW1 has become detached from its holder. 2. Booster heater fault 3. THW1 or THW2 or THW5B fault 4. FTC board failure	1. Visually inspect location and reattach as necessary. 2. Electrically test to determine fault. See "10-6. Checking Component Parts' Function" for how to check. 3. Check resistance of thermistor against table in "10-6. Checking Component Parts' Function". Compare FTC detected temperature to hand held detector. 4. Replace board.
	Heating operation error Note: "A" is displayed in "Request code: 567" in "Running information".	1. THW6 has become detached from its holder. 2. THW6 or THW7 fault 3. FTC board failure	1. Visually inspect location and reattach as necessary. 2. Check resistance of thermistor against table in "10-6. Checking Component Parts' Function". Compare FTC detected temperature to hand held detector. 3. Replace board.
	Heating operation error Note: "C" is displayed in "Request code: 567" in "Running information".	1. THW8 has become detached from its holder. 2. THW8 or THW9 fault 3. FTC board failure	1. Visually inspect location and reattach as necessary. 2. Check resistance of thermistor against table in "10-6. Checking Component Parts' Function". Compare FTC detected temperature to hand held detector. 3. Replace board.
L9	Low primary circuit (Heat source side) flow rate detected by flow sensor Note: "1" is displayed in "Request code: 569" in "Running information". <DHW/Heating/Cooling/LP/FS> Check code displayed when flow sensor detects low flow rate for 10 seconds. <u>Exception</u> For 1 minute after water circulation pump1 is switched on.	1. Insufficient system head 2. Reduced flow in primary water circuit Due to 1 or more of the following; Faulty pump, insufficient air purge, blocked strainer, leak in water circuit 3. Valve operation fault 4. 2-way valve (local supply) actuator fault 5. Connector wire has become detached or loose wiring. 6. Flow sensor fault 7. Incorrect setting of the SW2-2 8. FTC board failure	1. Refer to table in "10-6. Checking Component Parts' Function" to determine if system pump meets requirements. If more head required either add a pump of the same size or replace existing pump with capacity model. See "11. DISASSEMBLY PROCEDURE" for how to replace pump. 2. Check circulation pump (See "10-6. Checking Component Parts' Function" for how to check). Open purge valve to remove trapped air. Check the strainer for blockages. Check the primary water circuit for leaks. Check that the flow amount is within the recommended range. 3. Check valves on primary water circuit are installed level. 4. Electrically test to determine fault. 5. Visually check the CN1A connector and reattach if necessary. 6. Electrically test to determine fault. See "10-6. Checking Component Parts' Function" for how to check. 7. Check the SW2-2 setting. 8. Replace board.
	Low primary circuit (Zone1 side) flow rate detected by flow switch Note: "2" is displayed in "Request code: 569" in "Running information".	1. Insufficient system head 2. Reduced flow in primary water circuit Due to 1 or more of the following; Faulty pump, insufficient air purge, blocked strainer, leak in water circuit 3. Terminal wire has become detached or loose wiring. 4. Flow switch fault 5. Incorrect setting of the SW3-2 6. FTC board failure	1. If more head required either add a pump of the same size or replace existing pump. 2. Check circulation pump (See "10-6. Checking Component Parts' Function" for how to check). Open purge valve to remove trapped air. Check the strainer for blockages. Check the primary water circuit for leaks. Check that the flow amount is within the recommended range. 3. Visually check the IN3 terminal and reattach if necessary. 4. Electrically test to determine fault. 5. Check the SW3-2 setting. 6. Replace board.

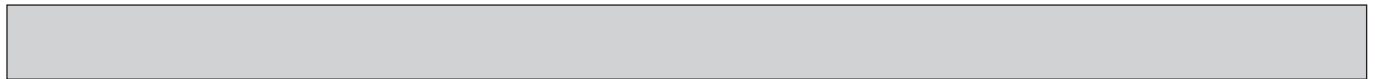

Check code	Title and display conditions	Possible Cause	Diagnosis and action
L9	Low primary circuit (Zone2 side) flow rate detected by flow switch Note: "3" is displayed in "Request code: 569" in "Running information".	<ol style="list-style-type: none"> Insufficient system head Reduced flow in primary water circuit Due to 1 or more of the following; Faulty pump, insufficient air purge, blocked strainer, leak in water circuit Terminal wire has become detached or loose wiring. Flow switch fault Incorrect setting of the SW3-3 FTC board failure 	<ol style="list-style-type: none"> If more head required either add a pump of the same size or replace existing pump. Check circulation pump (See "10-6. Checking Component Parts' Function" for how to check). Open purge valve to remove trapped air. Check the strainer for blockages. Check the primary water circuit for leaks. Check that the flow amount is within the recommended range. Visually check the IN7 terminal and reattach if necessary. Electrically test to determine fault. Check the SW3-3 setting. Replace board.
LA	Pressure sensor failure	<ol style="list-style-type: none"> Connector/terminal wire has become detached or loose wiring. Pressure sensor fault FTC board failure 	<ol style="list-style-type: none"> Check pressure sensor cable for damage or loose connections. Electrically test to determine fault. See "10-6. Checking Component Parts' Function" for how to check. Replace board.
LB	High pressure protection	<ol style="list-style-type: none"> Flow rate of the heating circuit may be reduced. Plate heat exchanger may be clogged. Outdoor unit failure 	<ol style="list-style-type: none"> Check water circuit. Check the plate heat exchanger. Refer to outdoor unit service manual.
LC	Boiler circulation water temperature overheat protection <DHW/Heating/LP/FS/OS> Check code displayed when THWB1 detects a temperature $\geq 80^{\circ}\text{C}$ for 10 consecutive seconds	<ol style="list-style-type: none"> The set temperature for Boiler is too high. Flow rate of the heating circuit from the boiler may be reduced. 	<ol style="list-style-type: none"> Check if the set temperature for Boiler for heating exceeds the restriction. (See the manual for the thermistors "PAC-TH011HT-E") Check for <ul style="list-style-type: none"> water leakage strainer blockage water circulation pump function
LD	Boiler temperature thermistor (THWB1) failure	Refer to check codes (P1/P2/L5/LD).	
LE	Boiler operation error <Heating> Boiler is running and THW6 detects a temperature $< 30^{\circ}\text{C}$ for consecutive 60 minutes.	<ol style="list-style-type: none"> THW6 has become detached from its holder. Incorrect wiring between FTC (OUT10) and the boiler Boiler fuel has run out or the system is OFF. Boiler failure FTC board failure 	<ol style="list-style-type: none"> Visually inspect location and reattach as necessary. See the manual of the thermistors "PAC-TH011HT-E". Check the status of the boiler. Check the status of the boiler. Replace board.
LF	Flow sensor failure	Disconnection or loose connection of flow sensor	Check flow sensor cable for damage or loose connections.
LH	Boiler circulation water freeze protection	Flow rate of the heating circuit from the boiler may be reduced.	Check for <ul style="list-style-type: none"> water leakage strainer blockage water circulation pump function
LJ	DHW operation error (type of external plate HEX)	<ol style="list-style-type: none"> DHW tank water temp. thermistor (THW5B) has become detached from its holder. Flow rate of the sanitary circuit may be reduced. 	<ol style="list-style-type: none"> Check for disconnection of DHW tank water temp. thermistor (THW5B). Check for water circulation pump function.
LL	Setting errors of DIP switches on FTC control board	<p>Incorrect setting of DIP switches</p> <ol style="list-style-type: none"> Boiler operation 2-zone temperature control Multiple outdoor units control 	<ol style="list-style-type: none"> For boiler operation, check that DIP SW1-1 is set to ON (With Boiler) and DIP SW2-6 is set to ON (With Mixing Tank). For 2-zone temperature control, check DIP SW2-7 is set to ON (2-zone) and DIP SW2-6 is set to ON (With Mixing Tank). For multiple outdoor units control, check DIP SW1-3 is set to ON on FTC (sub) that runs DHW operation .
P1	Indoor unit temperature thermistor (TH1A/TH1B) failure	Refer to check codes (P1/P2/L5/LD).	
P2	Indoor unit temperature thermistor (TH2) failure	Refer to check codes (P1/P2/L5/LD).	

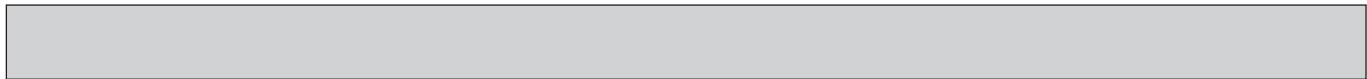

Check code	Title and display conditions	Possible Cause	Diagnosis and action
P6	<p>Anti-freeze protection of plate heat exchanger <Cooling> The check code displayed when Ref. liquid temp. (TH2) stays at -5°C or lower for 10 seconds after compressor operates for 6 minutes.</p> <p><Defrosting> THW2 detects a temperature ≤15°C and TH2 detects a temperature ≤-16°C for consecutive 10 seconds.</p>	<p><Cooling></p> <ol style="list-style-type: none"> Reduced water flow <ul style="list-style-type: none"> Clogged filter Leakage of water Low temperature <ul style="list-style-type: none"> Low load Inlet water is too cold. Defective water pump Defective outdoor fan control Overcharge of refrigerant Defective refrigerant circuit (clogs) Malfunction of linear expansion valve <p><Defrosting></p> <ol style="list-style-type: none"> Reduced water flow <ul style="list-style-type: none"> Clogged filter Leakage of water Low temperature <ul style="list-style-type: none"> Low load Inlet water is cold. Defective water pump Leakage or shortage of refrigerant Malfunction of linear expansion valve 	<ol style="list-style-type: none"> 2. Check water piping. 3. Check water pump. 4. Check outdoor fan motor. 6. Check operating condition of refrigerant circuit. 7. Check linear expansion valve.
E0/E4	<p>Main remote controller communication failure (Reception error) Check code E0 is displayed if main remote controller does not receive any signal from the indoor unit for ref. address "0" for 3 minutes. Check code E4 is displayed if indoor unit does not receive any data from the main remote controller for 3 minutes or indoor unit does not receive any signal from the main remote controller for 2 minutes.</p>	<ol style="list-style-type: none"> Contact failure with transmission cable Wiring procedure not observed. (Cable length/cable diameter/number of indoor units/number of main remote controllers) Fault on the indoor unit FTC board section controlling Ref. address "0" Fault with the main remote controller circuit board Electrical noise causes interference with transmission/reception of data for main remote controller. 	<ol style="list-style-type: none"> Check connection cable for damage or loose connections at the FTC and main remote controller terminals. Check main remote controller and FTC common wiring max cable length 500 m. Only use 2-core cable. Only connect 1 main remote controller to 1 FTC indoor unit board. to 5. If the problem is not solved by the above measures then: Turn the power to the indoor unit OFF and then ON. Power to both the indoor unit and outdoor units should be switched OFF then ON. (This may require switching 1 or 2 breakers depending if the unit is powered independently from the outdoor unit). If the E4 code is still displayed the FTC and/or the main remote controller circuit board should be replaced.
E3/E5	<p>Main remote controller communication failure (Transmission error) Check code E3 is displayed if the main remote controller cannot find an empty transmission path and thus fails to transmit for 6 seconds or the data received by the main remote controller is different to what was sent (by the main remote controller) 30 consecutive times. Check code E5 is displayed if the FTC cannot find an empty transmission path for 3 minutes and thus cannot transmit or the data sent by the FTC is different to what was expected 30 consecutive times.</p>	<ol style="list-style-type: none"> 2 or more main remote controllers have been connected to the FTC. Fault with main remote controller transmission/receiving circuit board Fault with the main remote controller circuit board Electrical noise causes interference with transmission/reception of data for main remote controller. 	<ol style="list-style-type: none"> Only connect 1 main remote controller to 1 FTC indoor unit board. to 4. Turn the power to the indoor unit OFF and then ON. Power to both the indoor unit and outdoor units should be switched OFF then ON. (This may require switching 1 or 2 breakers depending if the unit is powered independently from the outdoor unit). If the E3/E5 code is still displayed the FTC and/or the main remote controller circuit board should be replaced.
E6	<p>Indoor/outdoor communication failure (Reception error) Check code E6 is displayed if after the power is switched ON to the indoor unit, the FTC board does not receive any signal or the signal received is not complete for 6 minutes, or after a period of operation the FTC board does not receive any signal or the signal received is not complete for 3 minutes.</p>	<ol style="list-style-type: none"> Contact failure/short circuit/miswiring Fault with outdoor unit transmission/receiving circuit board Fault with FTC transmission/receiving circuit board Electrical noise causes interference with FTC-Outdoor unit transmission cable. 	<p>Note: Check the LED display on the outdoor unit circuit board. (Connect the A-control service tool, PAC-SK52ST to test.) Refer to the outdoor unit service manual for explanation of EA-EC codes.</p> <ol style="list-style-type: none"> Check the connections on the indoor and outdoor units have not become loose and that the connecting cable is not damaged. to 4. Turn the power to the indoor unit OFF and then ON. Power to both the indoor unit and outdoor units should be switched OFF then ON. (This may require switching 1 or 2 breakers depending if the unit is powered independently from the outdoor unit). If the E6 code is still displayed the FTC and/or the outdoor unit circuit board should be replaced.

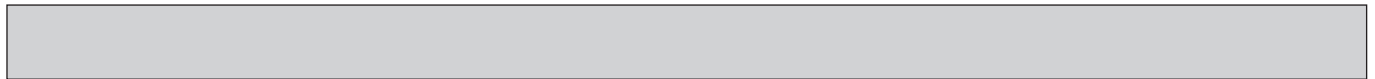

Check code	Title and display conditions	Possible Cause	Diagnosis and action
E7	Indoor/outdoor communication failure (Transmission error) Check code E7 is displayed if signal "1" is received 30 consecutive times despite the FTC board sending signal "0".	<ol style="list-style-type: none"> 1. Fault with FTC transmission/receiving circuit board 2. Electrical noise causes interference with power supply. 3. Electrical noise causes interference with FTC-outdoor unit transmission cable. 	<ol style="list-style-type: none"> 1. to 3. Turn the power to the indoor unit OFF and then ON. Power to both the indoor unit and outdoor units should be switched OFF then ON. (This may require switching 1 or 2 breakers depending if the unit is powered independently from the outdoor unit). If the E7 code is still displayed the FTC circuit board should be replaced.
E1/E2	Main remote controller control board failure Check code E1 displayed if main remote controller cannot access it is non-volatile (non power dependent) memory. Check code E2 is displayed when there is a fault with the main remote controller's internal clock.	<ol style="list-style-type: none"> 1. Fault with the main remote controller circuit board 	<ol style="list-style-type: none"> 1. Replace main remote controller circuit board.
J0	Indoor unit/wireless receiver communication failure Check code J0 is displayed when the FTC cannot receive data from the wireless receiver for 1 minute.	<ol style="list-style-type: none"> 1. Connection fault with wireless receiver-FTC connection 2. Fault with FTC receiving circuit board 3. Fault with wireless receiver's transmission circuit board 4. Electrical noise causes interference with wireless receiver communication cable. 	<ol style="list-style-type: none"> 1. Check the connections to the wireless receiver and FTC have not become loose and that the connecting cable is not damaged. 2. to 4. Turn the power to the indoor unit OFF and then ON. Power to both the indoor unit and outdoor units should be switched OFF then ON. (This may require switching 1 or 2 breakers depending if the unit is powered independently from the outdoor unit). If the J0 code is still displayed, the FTC and/or the wireless receiver circuit board should be replaced.
J1 to J8	Wireless remote controller/wireless receiver communication failure (Reception error) Check code displayed if wireless receiver receives no/incomplete data from the wireless remote controller for 15 consecutive minutes. The digit after the J refers to the address of the wireless remote controller that has the error. E.g. Check code "J3" refers to a communication fault between the wireless receiver and wireless remote control with address 3.	<ol style="list-style-type: none"> 1. Battery on wireless remote control may be flat. 2. The wireless remote controller is out of range of the wireless receiver. 3. Fault with wireless remote controller transmission circuit board 4. Fault with wireless receiver's reception circuit board 	<ol style="list-style-type: none"> 1. Check and replace the battery on wireless remote control if necessary. 2. to 4. Reposition the wireless remote control closer to the receiver and perform a communication test. For procedure, refer to wireless remote controller installation manual. If "OK" is displayed, then the cause of the J1 to J8 error was the controller was out of range of the receiver. The wireless remote controller should be installed within range of the receiver. If "Err" is displayed, replace wireless remote controller with a new controller and perform the pairing procedure. If the "Err" code is still displayed after this procedure, the fault is with the receiver unit (attached to the indoor unit). The receiver unit should be replaced with a new part and the original remote control can be reconnected. If "OK" is displayed, then the fault is with the remote control and this should be replaced.
J9	Main remote controller communication failure Check code J9 is displayed when signal is not received normally from FTC (sub) for 3 minutes.	Refer to check codes. (E0 and E4)	
EE	Combination error between FTC and outdoor unit	R410A outdoor unit is combined incorrectly.	Check combination of FTC and outdoor unit.
U*, F*, A*	Outdoor unit failure	Outdoor unit failure	Refer to outdoor unit service manual.

Note: To cancel check codes please switch system off (press button F4 (RESET) on main remote controller).

10-5. Troubleshooting by inferior phenomena

No.	Fault symptom	Possible cause	Explanation - Solution
1	Main remote controller display is blank.	<ol style="list-style-type: none"> There is no power supply to main remote controller. Power is supplied to main remote controller, however, the display on the main remote controller does not appear. 	<ol style="list-style-type: none"> Check LED2 on FTC. (See "6. WIRING DIAGRAM".) <ol style="list-style-type: none"> When LED2 is lit. Check for damage or contact failure of the main remote controller wiring. When LED2 is blinking. Refer to No. 5 below. When LED2 is not lit. Refer to No. 4 below. Check the following: <ul style="list-style-type: none"> Disconnection between the main remote controller cable and the FTC control board Failure of the main remote controller if "Please Wait" is not displayed. Refer to No. 2 below if "Please Wait" is displayed.
2	"Please Wait" remains displayed on the main remote controller.	<ol style="list-style-type: none"> "Please Wait" is displayed for up to 6 minutes. Communication failure between the main remote controller and FTC Communication failure between FTC and outdoor unit 	<ol style="list-style-type: none"> Normal operation, no action necessary. 3. Main remote controller start up checks/procedure <ol style="list-style-type: none"> If "0%" or "50 to 99%" is displayed below "Please Wait" there is a communication error between the main remote controller and the FTC control board. <ul style="list-style-type: none"> Check wiring connections on the main remote controller. Replace the main remote controller or the FTC control board. If "1 to 49%" is displayed there is a communication error between the outdoor unit's and FTC's control boards. <ul style="list-style-type: none"> Check the wiring connections on the outdoor unit control board and the FTC control board. (Ensure S1 and S2 are not cross-wired and S3 is securely wired with no damage. See "7. FIELD WIRING".) Replace the outdoor unit's and/or the FTC's control boards.
3	The main screen appears with a press of the "ON" button, but disappears in a second.	The main remote controller operations do not work for a while after the settings are changed in the service menu. This is because the system takes time to apply the changes.	Normal operation, no action necessary. The indoor unit is applying updated settings made in the service menu. Normal operation will start shortly.
4	LED2 on FTC is off. (See "6. WIRING DIAGRAM".)	<p>When LED1 on FTC is also off. (See "6. WIRING DIAGRAM".) <FTC powered via outdoor unit.></p> <ol style="list-style-type: none"> The outdoor unit is not supplied at the rated voltage. Defective outdoor controller circuit board FTC is not supplied with 220 to 240 VAC. FTC failure Faulty connector wiring 	<ol style="list-style-type: none"> Check the voltage across the terminals L and N or L3 and N on the outdoor power board. (See "7. FIELD WIRING".) <ul style="list-style-type: none"> When the voltage is not 220 to 240 VAC, check wiring of the outdoor unit and of the breaker. When the voltage is at 220 to 240 VAC, go to "2." below. Check the voltage across the outdoor unit terminals S1 and S2. (See "7. FIELD WIRING".) <ul style="list-style-type: none"> When the voltage is not 220 to 240 VAC, check the fuse on the outdoor control board and check for faulty wiring. When the voltage is 220 to 240 VAC, go to "3." below. Check the voltage across the indoor unit terminals S1 and S2. (See "7. FIELD WIRING".) <ul style="list-style-type: none"> When the voltage is not 220 to 240 VAC, check FTC-outdoor unit wiring for faults. When the voltage is 220 to 240 VAC, go to "4." below. Check the FTC control board. <ul style="list-style-type: none"> Check the fuse on FTC control board. Check for faulty wiring. If no problem found with the wiring, the FTC control board is faulty. Check the connector wiring. <ul style="list-style-type: none"> When the connectors are wired incorrectly, re-wire the connectors referring to below. (See "7. FIELD WIRING".)

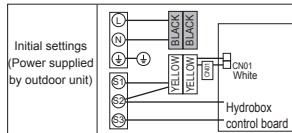

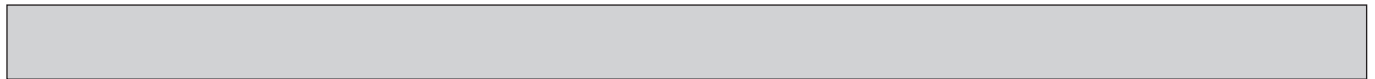

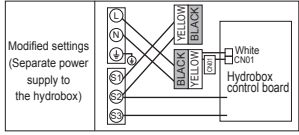
No.	Fault symptom	Possible cause	Explanation - Solution
4	LED2 on FTC is off. (See "6. WIRING DIAGRAM".)	<FTC powered on independent source> 1. FTC is not supplied with 220 to 240 VAC.	1. Check the voltage across the L and N terminals on the indoor power supply terminal block. (See "7. FIELD WIRING".) • When the voltage is not 220 to 240 VAC, check for faulty wiring to power supply. • When the voltage is 220 to 240 VAC, go to 2. below. 2. Check for faulty wiring between the connectors. • When the connectors are wired incorrectly re-wire them correctly referring to below. (See "7. FIELD WIRING". and a wiring diagram on the control and electrical box cover.)  • If no problem found with the wiring, go to 3. below. 3. Check the FTC control board. • Check the fuse on FTC control board. • Check for faulty wiring. • If no problem found with the wiring, the FTC control board is faulty.
		2. There are problems in the method of connecting the connectors.	
		3. FTC failure	
		When LED1 on FTC is lit: Incorrect setting of refrigerant address for outdoor unit (None of the refrigerant address is set to "0".)	Recheck the refrigerant address setting on the outdoor unit. Set the refrigerant address to "0". (Set refrigerant address using SW1(3-6) on outdoor controller circuit board.)
5	LED2 on FTC is blinking. (See "6. WIRING DIAGRAM".)	When LED1 is also blinking on FTC: Faulty wiring between FTC and outdoor unit	Check for faulty wiring between FTC and outdoor unit.
		When LED1 on FTC is lit: 1. Faulty wiring in main remote controller Multiple indoor units have been wired to a single outdoor unit. 2. Short-circuited wiring in main remote controller 3. Main remote controller failure	1. Check for faulty wiring in main remote controller. The number of indoor units that can be wired to a single outdoor unit is one. Additional indoor units must be wired individually to a single outdoor unit. 2,3. Remove main remote controller wires and check LED2 on FTC. (See Figure 5.2.1. in installation manual) • If LED2 is blinking check for short circuits in the main remote controller wiring. • If LED2 is lit, wire the main remote controller again and: - if LED2 is blinking, the main remote controller is faulty; - if LED2 is lit, faulty wiring of the main remote controller has been corrected.
6	LED4 on FTC is off. (See "6. WIRING DIAGRAM".)	1. SD memory card is NOT inserted into the memory card slot with correct orientation. 2. Not an SD standards compliant memory card	1. Correctly insert SD memory card in place until a click is heard. 2. Use an SD standards compliant memory card. (Refer to section 5.6 in installation manual)
	LED4 on FTC is blinking. (See "6. WIRING DIAGRAM".)	1. Full of data 2. Write-protected 3. NOT formatted 4. Formatted in NTFS file system	1. Move or delete data, or replace SD memory card with a new one. 2. Release the write-protect switch. 3. Refer to "5.6 Using SD memory card" in installation manual. 4. FTC is Not compatible with NTFS file system. Use an SD memory card formatted in FAT file system.
7	No water at hot tap.	1. Cold main off 2. Strainer (local supply) blocked	1. Check and open stop cock. 2. Isolate water supply and clean strainer.
8	Cold water at tap.	1. Hot water run out. 2. Prohibit, schedule timer or holiday mode selected or demand control input (IN4) or smart grid ready (switch-off command). 3. Heat pump not working 4. Booster heater cut-out tripped. 5. The earth leakage circuit breaker for booster heater breaker (ECB1) tripped. 6. The booster heater thermal cut-out has tripped and cannot be reset using the manual reset button. 7. Immersion heater cut-out tripped. 8. Immersion heater breaker (ECB2) tripped. 9. 3-way valve fault	1. Ensure DHW mode is operating and wait for DHW tank to re-heat. 2. Check settings and change as appropriate. 3. Check heat pump – consult outdoor unit service manual. 4. Check booster heater thermostat and press reset button if safe. Reset button is located on the side of booster heater, covered with white rubber cap. See "4. PART NAMES AND FUNCTIONS" to find out its position. 5. Check the cause and reset if safe. 6. Check resistance across the thermal cut-out, if open then the connection is broken and the booster heater will have to be replaced. Contact your Mitsubishi Electric dealer. 7. Check immersion heater thermostat and press reset button, located on immersion heater boss, if safe. If the heater has been operated with no water inside it may have failed, so please replace it with a new one. 8. Check the cause and reset if safe. 9. Check plumbing/wiring to 3-way valve. (i) Manually override 3-way valve using the main remote controller. (Refer to <Manual operation> in section "9-4. Service menu".) If the valve does not still function, go to (ii) below. (ii) Replace 3-way valve.



No.	Fault symptom	Possible cause	Explanation - Solution
9	Water heating takes longer.	<ol style="list-style-type: none"> 1. Heat pump not working 2. Booster heater cut-out tripped. 3. Booster heater breaker (ECB1) tripped. 4. The booster heater thermal cut-out has tripped and cannot be reset using the manual reset button. 5. Immersion heater cut-out has been triggered. 6. Immersion heater breaker (ECB2) tripped. 	<ol style="list-style-type: none"> 1. Check heat pump – consult outdoor unit service manual. 2. Check booster heater thermostat and press reset button if safe. Reset button is located on the side of booster heater, covered with white rubber cap. See "4. PART NAMES AND FUNCTIONS" to find out its position. 3. Check the cause and reset if safe. 4. Check resistance across the thermal cut-out, if open then connection is broken and the booster heater will have to be replaced. Contact your Mitsubishi Electric dealer. 5. Check immersion heater thermostat and press reset button if safe. If the heater kept running with no water inside, this may have resulted in failure, so replace it with a new one. 6. Check the cause and reset if safe.
10	Temperature of DHW tank water dropped.	<p>When DHW operation is not running, the DHW tank emits heat and the water temperature decreases to a certain level. If water in the DHW tank is reheated frequently because of a significant drop in water temperature, check for the following.</p> <ol style="list-style-type: none"> 1. Water leakage in the pipes that connect to the DHW tank 2. Insulation material coming loose or off 3. 3-way valve failure 	<ol style="list-style-type: none"> 1. Take the following measures. <ul style="list-style-type: none"> • Retighten the nuts holding the pipes onto the DHW tank. • Replace seal materials. • Replace the pipes. 2. Fix insulation. 3. Check plumbing/wiring to 3-way valve. <ol style="list-style-type: none"> (i) Manually override 3-way valve using the main remote controller. (Refer to <Manual operation> in "9-4. Service Menu".) If the valve does not still function, go to (ii) below. (ii) Replace 3-way valve.
11	Hot or warm water from cold tap.	Heat of hot water pipe is transferred to cold water pipe.	Insulate/re-route pipework.
12	Water leakage	<ol style="list-style-type: none"> 1. Poorly sealed connections of water circuit components 2. Water circuit components reaching the end of life 	<ol style="list-style-type: none"> 1. Tighten connections as required. 2. Refer to PARTS CATALOG in the service manual for expected part lifetimes and replace them as necessary.
13	Heating system does not reach the set higher temperature.	<ol style="list-style-type: none"> 1. Prohibit, schedule timer or holiday mode selected or demand control input (IN4) or smart grid ready (switch-off command). 2. Check settings and change as appropriate. 3. The temperature sensor is located in a room that has a different temperature relative to that of the rest of the house. 4. Heat pump not working 5. Booster heater cut-out tripped. 6. Booster heater breaker (ECB1) tripped. 7. The booster heater thermal cut-out tripped and cannot be reset using the manual reset button. 8. Incorrectly sized heat emitter 9. 3-way valve failure 10. Battery problem (*wireless control only) 11. If a mixing tank is installed, the flow rate between the mixing tank and the hydrobox is less than that between the mixing tank and the local system. 	<ol style="list-style-type: none"> 1. Check settings and change as appropriate. 2. Check the battery power and replace if flat. 3. Relocate the temperature sensor to a more suitable room. 4. Check heat pump – consult outdoor unit service manual. 5. Check booster heater thermostat and press reset button if safe. Reset button is located on the side of booster heater, covered with white rubber cap. (See "4. PART NAMES AND FUNCTIONS" for position.) 6. Check the cause of the trip and reset if safe. 7. Check resistance across the thermal cut-out, if open then the connection is broken and the booster heater will have to be replaced. Contact your Mitsubishi Electric dealer. 8. Check the heat emitter surface area is adequate Increase size if necessary. 9. Check plumbing/wiring to 3-way valve. 10. Check the battery power and replace if flat. 11. Increase the flow rate between the mixing tank and the hydrobox or decrease that between the mixing tank and the local system.
14	Heating system does not reach the set lower temperature.	The heating system operates according to the heating pressure to prevent the low pressure system from frequent switching (ON/OFF) of the compressor.	Normal operation, no action necessary.

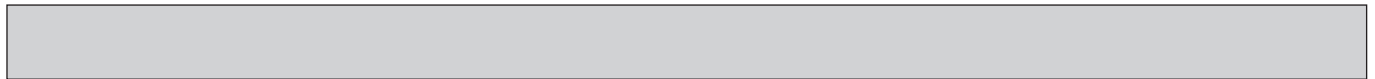

No.	Fault symptom	Possible cause	Explanation - Solution
15	In 2-zone temperature control, only Zone2 does not reach the set temperature.	<ol style="list-style-type: none"> When Zone1 and Zone2 are both in heating mode, the hot water temperature in Zone2 does not exceed that in Zone1. Faulty wiring of motorized mixing valve Faulty installation of motorized mixing valve Incorrect setting of Running time Motorized mixing valve failure 	<ol style="list-style-type: none"> Normal operation, no action necessary. Refer to "5.3 Wiring for 2-zone temperature control" in installation manual. Check for correct installation. (Refer to the manual included with each motorized mixing valve.) Check for correct setting of Running time. Inspect the mixing valve. (Refer to the manual included with each motorized mixing valve.)
16	When a PUAZ-FRP outdoor unit is connected, DHW or Heating operation cannot run.	The outdoor unit is set to have operation of the indoor unit of air conditioner take precedence over that of the hydrobox, and in the main remote controller settings "Electric heater (Heating)" or "Electric heater (DHW)" is turned off.	Turn ON Electric heater (Heating) or Electric heater (DHW) using the main remote controller.
17	When a PUAZ-FRP outdoor unit is connected and is in heat recovery operation, the set temperature is not reached.	When the outdoor unit is set to have cooling operation of the indoor unit of air conditioner take precedence over that of the hydrobox, the outdoor unit controls the frequency of the compressor according to the load of air conditioner. The DHW and heating run according to that frequency.	Normal operation, no action necessary. If Air-to-Water system is given priority in operation, comp Hz can be regulated depending on the load of DHW or Heating. For more details, refer to the PUAZ-FRP installation manual.
18	After DHW operation room temperature rises slightly.	At the end of the DHW mode operation the 3-way valve diverts hot water away from the DHW circuit into space heating circuit. This is done to prevent the hydrobox components from overheating. The amount of hot water directed into the space heating circuit varies according to the type of the system and of the pipe run between the plate heat exchanger and the hydrobox.	Normal operation, no action necessary.
19	The room temperature rises during DHW operation.	3-way valve failure	Check the 3-way valve.
20	Water discharges from pressure relief valve. (Primary circuit)	<ol style="list-style-type: none"> If continual – pressure relief valve may be damaged. If intermittent – expansion vessel charge may have reduced/bladder perished. 	<ol style="list-style-type: none"> Turn the handle on the pressure relief valve to check for foreign objects in it. If the problem is not still solved, replace the pressure relief valve with a new one. Check pressure in expansion vessel. Recharge to 1 bar if necessary. If bladder perished, replace expansion vessel with a new one.
21	Water discharges from pressure relief valve (field supplied item). (Sanitary circuit)	<ol style="list-style-type: none"> If continual – field supplied pressure reducing valve not working. If continual – pressure relief valve seat may be damaged. If intermittent – expansion vessel charge may have reduced/bladder perished. DHW tank may have subjected to backflow. 	<ol style="list-style-type: none"> Check function of pressure reducing valve and replace if necessary. Turn the handle on the pressure relief valve to check for foreign objects inside. If the problem is not still solved, replace the pressure relief valve. Check gas-side pressure in expansion vessel. Recharge to correct precharge pressure if necessary. If bladder perished, replace expansion vessel with a new one with appropriate pre-charge. Check the pressure in DHW tank. If pressure in DHW tank is similar to that in the incoming mains, cold water supply that merges with incoming mains water supply could flow back to DHW tank. Investigate source of back-feed and rectify error in pipework/fitting configuration. Adjust pressure in cold supply.
22	Noisy water circulation pump	Air in water circulation pump	Use manual and automatic air vents to remove air from system. Top up water if necessary to achieve 1 bar on primary circuit.
23	Noise during hot water draw off typically worse in the morning.	<ol style="list-style-type: none"> Loose airing cupboard pipework Heaters switching on/off 	<ol style="list-style-type: none"> Install extra pipe fastening clips. Normal operation, no action necessary.
24	Mechanical noise heard coming from the hydrobox.	<ol style="list-style-type: none"> Heaters switching on/off 3-way valve changing position between DHW and heating mode 	Normal operation, no action necessary.
25	Water circulation pump runs for a short time unexpectedly.	Water circulation pump jam prevention mechanism (routine) to inhibit the build-up of scale	Normal operation, no action necessary.
26	Milky/Cloudy water (Sanitary circuit)	Oxygenated water	Water from any pressurised system will release oxygen bubbles when water is running. The bubbles will settle out.
27	Heating mode has been on standby for a long time (does not start operation smoothly.)	The time of "Delay" set in "Economy settings for pump" is too short. (Go to "Service menu" → "Auxiliary settings" → "Economy settings for pump").	Increase the time of "Delay" in "Economy settings for pump" .

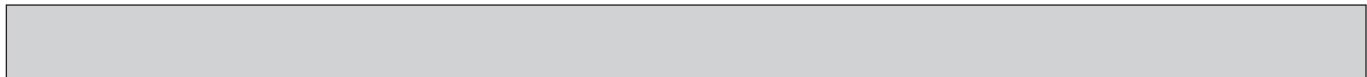

No.	Fault symptom	Possible cause	Explanation - Solution																
28	The hydrobox that was running in the heating mode before power failure is running in the DHW mode after power recovery.	The hydrobox is designed to run in an operation mode with a higher priority (i.e. DHW mode in this case) at power recovery.	<ul style="list-style-type: none"> Normal operation, no action necessary. After the DHW max. operation time has elapsed or the DHW max. temperature has been reached, the DHW mode switches to the other mode (ex. Heating mode). 																
29	Cooling mode is NOT available.	DIP SW2-4 is OFF.	Turn DIP SW2-4 to ON. (Refer to "6-6 DIP switch functions".)																
30	The cooling system does not cool down to the set temperature.	<ol style="list-style-type: none"> When the water in the circulation circuit is unduly hot, Cooling mode starts with a delay for the protection of the outdoor unit. When the outdoor ambient temperature is lower than the preset temperature that activates the freeze stat. function, Cooling mode does not start running. 	<ol style="list-style-type: none"> Normal operation, no action necessary. To run Cooling mode overriding the freeze stat. function, adjust the preset temperature that activates the freeze stat. function. (Refer to "<Freeze stat function>" on Page 30.) 																
31	The electric heaters are activated shortly after DHW or LP mode starts running after Cooling mode.	The setting time period of Heat-pump-only operation is short.	Adjust the setting time period of Heat-pump only operation. (Refer to "<Electric heater (DHW)>" on Page 28.)																
32	During DHW or LP mode following the cooling mode, error L6 (circulation water freeze protection error) occurs and the system stops all the operations.	The unit runs in Cooling mode when the outdoor ambient temperature is lower than 10°C (outside of the guaranteed operating range). (When defrosting operation is running at such a low outdoor ambient temperature after Cooling mode is switched to DHW or LP mode, the water temperature in the cooling circuit drops too low, which could result in L6 error to stop all the operations.	<p>Do not run Cooling operation when the outdoor ambient temperature is lower than 10°C.</p> <p>To automatically stop or recover only Cooling operation and keep other operations running, the freeze stat. function can be used. Set the preset temperature that activates the freeze stat. function to adjust the outdoor ambient temperature as follows. (Refer to "<Freeze stat function>" on Page 30.)</p> <table border="1"> <thead> <tr> <th>Outdoor ambient temperature</th> <th>Cooling operation</th> </tr> </thead> <tbody> <tr> <td>3°C higher than the preset temperature</td> <td>Stop</td> </tr> <tr> <td>5°C higher than the preset temperature</td> <td>Recover</td> </tr> </tbody> </table>	Outdoor ambient temperature	Cooling operation	3°C higher than the preset temperature	Stop	5°C higher than the preset temperature	Recover										
Outdoor ambient temperature	Cooling operation																		
3°C higher than the preset temperature	Stop																		
5°C higher than the preset temperature	Recover																		
33	<p>The energy monitor value seems not correct.</p> <p>Note: There could be some discrepancies between the actual and the calculated values. If you seek for accuracy, please make sure to connect power meter(s) and heat meter to FTC board. Both should be locally supplied.</p>	<ol style="list-style-type: none"> Incorrect setting of the energy monitor Non-connectable type of external meter (local supply) is connected. External meter (local supply) failure FTC board failure 	<ol style="list-style-type: none"> Check the setting by following the procedure below. <ol style="list-style-type: none"> Check if the DIP switch is set as the table below. <table border="1"> <thead> <tr> <th colspan="2">Consumed electric energy</th> <th colspan="2">Delivered heat energy</th> </tr> <tr> <th>SW3-4</th> <th>Electric energy meter (Local supply)</th> <th>SW3-8</th> <th>Heat meter (Local supply)</th> </tr> </thead> <tbody> <tr> <td>OFF</td> <td>Without</td> <td>OFF</td> <td>Without</td> </tr> <tr> <td>ON</td> <td>With</td> <td>ON</td> <td>With</td> </tr> </tbody> </table> In the case external electric energy meter and/or heat meter is not used, check if the setting for electric heater and water pump(s) input is correct by referring to <Energy monitor setting> in "9-4 Service menu". In the case external electric energy meter and/or heat meter is used, check if the unit of output pulse on external meter matches with the one set at the main remote controller by referring to <Energy monitor setting> in "9-4. Service menu". Check if the external meter (local supply) is connectable type by referring to <Energy monitor setting>" in "9-4 Service menu". Check if signal is sent to IN8 to IN10 properly. (Refer to "6. WIRING DIAGRAM".) Replace the external heat meter if defective. Check the FTC control board. <ul style="list-style-type: none"> Check for faulty wiring. If no problem found with the wiring, the FTC control board is faulty. Replace the board. 	Consumed electric energy		Delivered heat energy		SW3-4	Electric energy meter (Local supply)	SW3-8	Heat meter (Local supply)	OFF	Without	OFF	Without	ON	With	ON	With
Consumed electric energy		Delivered heat energy																	
SW3-4	Electric energy meter (Local supply)	SW3-8	Heat meter (Local supply)																
OFF	Without	OFF	Without																
ON	With	ON	With																
34	Heat pump is forced to turn ON and OFF.	Smart grid ready input (IN11 and IN12) is used, and switch-on and off commands are input.	Normal operation, no action necessary.																

Annual Maintenance

It is essential that the hydrobox is serviced at least once a year by a qualified individual any spare parts required MUST be purchased from Mitsubishi Electric (safety matter).

NEVER bypass safety devices or operate the unit without them being fully operational.

<Annual maintenance points>

Use the Annual Maintenance Log Book ("13-1. Annual Maintenance") as a guide to carrying out the necessary checks on the hydrobox and outdoor unit.

10-6. Checking Component Parts' Function

Part Name	Checkpoints																																																		
<p><Recommended water flow rate range></p> <table border="1"> <thead> <tr> <th>Outdoor heat pump unit</th> <th>Water flow rate range [L/min]</th> </tr> </thead> <tbody> <tr> <td rowspan="5">Packaged model</td> <td>PUZ-WM50</td> <td>6.5 – 14.3</td> </tr> <tr> <td>PUZ-WM60</td> <td>8.6 – 17.2</td> </tr> <tr> <td>PUZ-WM85</td> <td>10.8 – 24.4</td> </tr> <tr> <td>PUZ-WM112</td> <td>14.4 – 32.1</td> </tr> <tr> <td>PUZ-HWM140</td> <td>17.9 – 40.1</td> </tr> <tr> <td rowspan="17">Split model</td> <td>SUZ-SWM40</td> <td>6.5 – 11.4</td> </tr> <tr> <td>SUZ-SWM60</td> <td>7.2 – 17.2</td> </tr> <tr> <td>SUZ-SWM80</td> <td>7.8 – 21.5</td> </tr> <tr> <td>PUD-S(H)WM60</td> <td>9.0 – 22.9</td> </tr> <tr> <td>PUD-S(H)WM80</td> <td>9.0 – 22.9</td> </tr> <tr> <td>PUD-S(H)WM100</td> <td>14.3 – 34.4</td> </tr> <tr> <td>PUD-S(H)WM120</td> <td>14.3 – 34.4</td> </tr> <tr> <td>PUD-SHWM140</td> <td>14.3 – 34.4</td> </tr> <tr> <td>PUHZ-FRP71</td> <td>11.5 – 22.9</td> </tr> <tr> <td>PUHZ-SW75</td> <td>10.2 – 22.9</td> </tr> <tr> <td>PUHZ-SW100</td> <td>14.4 – 32.1</td> </tr> <tr> <td>PUHZ-SW120</td> <td>20.1 – 36.9</td> </tr> <tr> <td>PUHZ-SHW80</td> <td>10.2 – 22.9</td> </tr> <tr> <td>PUHZ-SHW112</td> <td>14.4 – 32.1</td> </tr> <tr> <td>PUHZ-SHW140</td> <td>17.9 – 36.9</td> </tr> <tr> <td>PUMY-P112</td> <td>17.9 – 35.8</td> </tr> <tr> <td>PUMY-P125</td> <td>17.9 – 35.8</td> </tr> <tr> <td>PUMY-P140</td> <td>17.9 – 35.8</td> </tr> </tbody> </table> <p><Table 10.6.1></p> <p>* If the water flow rate is less than the minimum flow rate setting of the flow sensor(default 5.0 L/min), the flow rate error will be activated. If the water flow rate exceeds 36.9 L/min, the flow speed will be greater than 2.0 m/s, which could erode the pipes.</p>	Outdoor heat pump unit	Water flow rate range [L/min]	Packaged model	PUZ-WM50	6.5 – 14.3	PUZ-WM60	8.6 – 17.2	PUZ-WM85	10.8 – 24.4	PUZ-WM112	14.4 – 32.1	PUZ-HWM140	17.9 – 40.1	Split model	SUZ-SWM40	6.5 – 11.4	SUZ-SWM60	7.2 – 17.2	SUZ-SWM80	7.8 – 21.5	PUD-S(H)WM60	9.0 – 22.9	PUD-S(H)WM80	9.0 – 22.9	PUD-S(H)WM100	14.3 – 34.4	PUD-S(H)WM120	14.3 – 34.4	PUD-SHWM140	14.3 – 34.4	PUHZ-FRP71	11.5 – 22.9	PUHZ-SW75	10.2 – 22.9	PUHZ-SW100	14.4 – 32.1	PUHZ-SW120	20.1 – 36.9	PUHZ-SHW80	10.2 – 22.9	PUHZ-SHW112	14.4 – 32.1	PUHZ-SHW140	17.9 – 36.9	PUMY-P112	17.9 – 35.8	PUMY-P125	17.9 – 35.8	PUMY-P140	17.9 – 35.8	<p><Water Circulation Pump Characteristics></p> <p>ERSC series</p> <p><Figure 10.6.1></p> <p>ERSD series</p> <p><Figure 10.6.2></p> <p>EHSC series</p> <p><Figure 10.6.3></p> <p>E*SE series</p> <p><Figure 10.6.4></p> <p>E*PX series</p> <p><Figure 10.6.6></p> <p>EHSD series</p> <p><Figure 10.6.5></p> <p>Note: For installation of E*PX series, set its pump speed with a pressure drop between the hydrobox and the outdoor unit factored into the external static pressure.</p>
Outdoor heat pump unit	Water flow rate range [L/min]																																																		
Packaged model	PUZ-WM50	6.5 – 14.3																																																	
	PUZ-WM60	8.6 – 17.2																																																	
	PUZ-WM85	10.8 – 24.4																																																	
	PUZ-WM112	14.4 – 32.1																																																	
	PUZ-HWM140	17.9 – 40.1																																																	
Split model	SUZ-SWM40	6.5 – 11.4																																																	
	SUZ-SWM60	7.2 – 17.2																																																	
	SUZ-SWM80	7.8 – 21.5																																																	
	PUD-S(H)WM60	9.0 – 22.9																																																	
	PUD-S(H)WM80	9.0 – 22.9																																																	
	PUD-S(H)WM100	14.3 – 34.4																																																	
	PUD-S(H)WM120	14.3 – 34.4																																																	
	PUD-SHWM140	14.3 – 34.4																																																	
	PUHZ-FRP71	11.5 – 22.9																																																	
	PUHZ-SW75	10.2 – 22.9																																																	
	PUHZ-SW100	14.4 – 32.1																																																	
	PUHZ-SW120	20.1 – 36.9																																																	
	PUHZ-SHW80	10.2 – 22.9																																																	
	PUHZ-SHW112	14.4 – 32.1																																																	
	PUHZ-SHW140	17.9 – 36.9																																																	
	PUMY-P112	17.9 – 35.8																																																	
	PUMY-P125	17.9 – 35.8																																																	
PUMY-P140	17.9 – 35.8																																																		

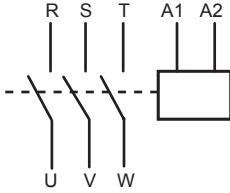
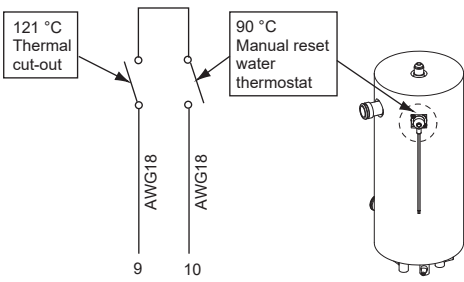
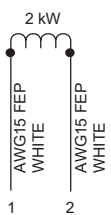
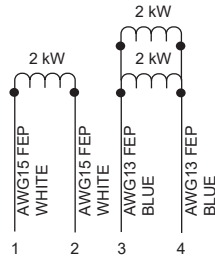
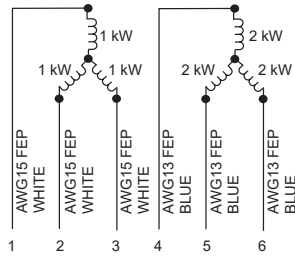
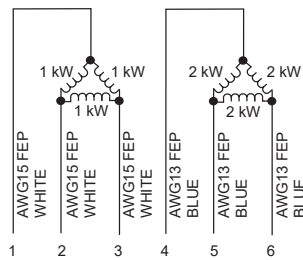

Part Name	Checkpoints									
<p>Earth leakage circuit breaker for heater</p>	<p>If a short circuit occurs on the booster heater, immersion heater, or each power line, a short-circuit breaker will trip and power source will be blocked. Eliminate the causes of short circuit and then turn on the breaker again.</p>									
<p>Relay for heater</p> 	<p>When the applied voltage is not 230 VAC across the terminals A1-A2, check the terminals R-U, S-V, and T-W are open. When the applied voltage is 230 VAC across the terminals A1-A2, check the terminals R-U, S-V, and T-W are short.</p>									
<p>Booster heater</p> <p>Thermostat (90°C) and thermal cut out (121°C)</p> 	<p>Measure the resistance between the terminals with a multimeter.</p> <table border="1" data-bbox="702 667 1316 721"> <thead> <tr> <th>Terminal</th> <th>Normal</th> <th>Abnormal</th> </tr> </thead> <tbody> <tr> <td>9-10</td> <td>80(±20) mΩ</td> <td>Open or Short</td> </tr> </tbody> </table>	Terminal	Normal	Abnormal	9-10	80(±20) mΩ	Open or Short			
Terminal	Normal	Abnormal								
9-10	80(±20) mΩ	Open or Short								
<p>2 kW heater (230 V, 1 phase)</p> 	<table border="1" data-bbox="702 1003 1316 1057"> <thead> <tr> <th>Terminal</th> <th>Normal</th> <th>Abnormal</th> </tr> </thead> <tbody> <tr> <td>1-2</td> <td>26.5(+3/-1.3) Ω</td> <td>Open or Short</td> </tr> </tbody> </table>	Terminal	Normal	Abnormal	1-2	26.5(+3/-1.3) Ω	Open or Short			
Terminal	Normal	Abnormal								
1-2	26.5(+3/-1.3) Ω	Open or Short								
<p>2 + 4 kW heater (230 V, 1 phase)</p> 	<table border="1" data-bbox="702 1258 1316 1339"> <thead> <tr> <th>Terminal</th> <th>Normal</th> <th>Abnormal</th> </tr> </thead> <tbody> <tr> <td>1-2</td> <td>26.5(+3/-1.3) Ω</td> <td>Open or Short</td> </tr> <tr> <td>3-4</td> <td>13.3(+1.5/-0.6) Ω</td> <td>Open or Short</td> </tr> </tbody> </table>	Terminal	Normal	Abnormal	1-2	26.5(+3/-1.3) Ω	Open or Short	3-4	13.3(+1.5/-0.6) Ω	Open or Short
Terminal	Normal	Abnormal								
1-2	26.5(+3/-1.3) Ω	Open or Short								
3-4	13.3(+1.5/-0.6) Ω	Open or Short								
<p>3 + 6 kW heater (400 V, 3 phase)</p> 	<table border="1" data-bbox="702 1572 1316 1653"> <thead> <tr> <th>Terminal</th> <th>Normal</th> <th>Abnormal</th> </tr> </thead> <tbody> <tr> <td>1-2=2-3=1-3</td> <td>105.8(+11.8/-5) Ω</td> <td>Open or Short</td> </tr> <tr> <td>4-5=5-6=4-6</td> <td>52.9(+5.8/-2.5) Ω</td> <td>Open or Short</td> </tr> </tbody> </table>	Terminal	Normal	Abnormal	1-2=2-3=1-3	105.8(+11.8/-5) Ω	Open or Short	4-5=5-6=4-6	52.9(+5.8/-2.5) Ω	Open or Short
Terminal	Normal	Abnormal								
1-2=2-3=1-3	105.8(+11.8/-5) Ω	Open or Short								
4-5=5-6=4-6	52.9(+5.8/-2.5) Ω	Open or Short								
<p>3 + 6 kW heater (230 V, 3 phase)</p> 	<table border="1" data-bbox="702 1886 1316 1966"> <thead> <tr> <th>Terminal</th> <th>Normal</th> <th>Abnormal</th> </tr> </thead> <tbody> <tr> <td>1-2=2-3=3-1</td> <td>35.3(+3.9/-1.8) Ω</td> <td>Open or Short</td> </tr> <tr> <td>4-5=5-6=6-4</td> <td>17.6(+1.9/-0.9) Ω</td> <td>Open or Short</td> </tr> </tbody> </table>	Terminal	Normal	Abnormal	1-2=2-3=3-1	35.3(+3.9/-1.8) Ω	Open or Short	4-5=5-6=6-4	17.6(+1.9/-0.9) Ω	Open or Short
Terminal	Normal	Abnormal								
1-2=2-3=3-1	35.3(+3.9/-1.8) Ω	Open or Short								
4-5=5-6=6-4	17.6(+1.9/-0.9) Ω	Open or Short								

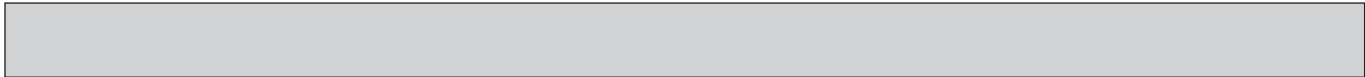

Part Name	Checkpoints
-----------	-------------

Thermistors

Disconnect the connector then measure the resistance with a multimeter.
(At ambient temperatures of 10 to 30°C.)

Thermistor	Normal	Abnormal
TH1	4.3 to 9.5 kΩ	Open or short
TH2		
THW1		
THW2		
THW5A		
THW5B		
THW6		
THW7		
THW8		
THW9		
THW10	40 to 100 kΩ	Open or short
THWB1		

Flow sensor

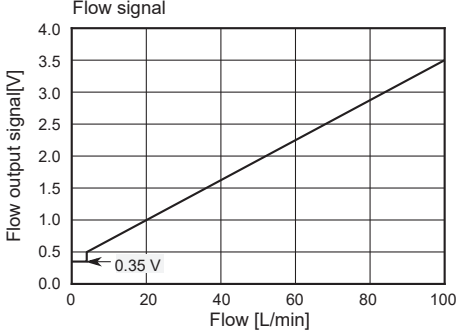
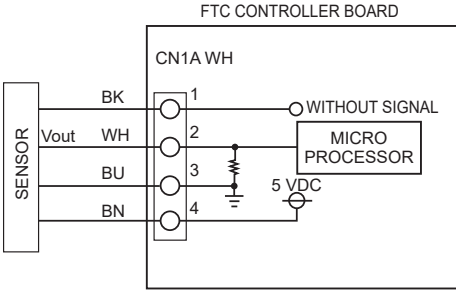

Pressure sensor

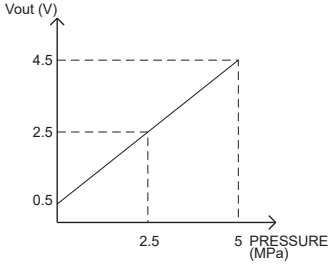
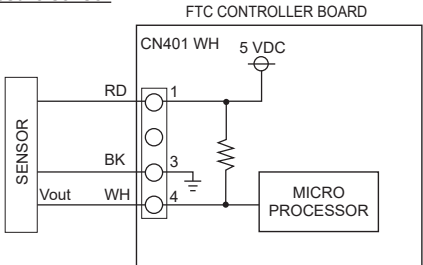

<Thermistors Characteristics Charts>

- Room temperature thermistor (TH1)
- Refrigerant liquid temperature thermistor (TH2)
- Flow water temperature thermistor (THW1)
- Return water temperature thermistor (THW2)
- DHW tank water temperature thermistor (THW5A/5B)
- Zone1 flow temperature thermistor (THW6)
- Zone1 return temperature thermistor (THW7)
- Zone2 flow temperature thermistor (THW8)
- Zone2 return temperature thermistor (THW9)

Thermistor R0 = 15 kΩ ± 3%
 B constant = 3480 ± 2%

$$R_t = 15 \exp \left\{ 3480 \left(\frac{1}{273+t} - \frac{1}{273} \right) \right\}$$

0°C	15 kΩ
10°C	9.6 kΩ
20°C	6.3 kΩ
25°C	5.2 kΩ
30°C	4.3 kΩ
40°C	3.0 kΩ

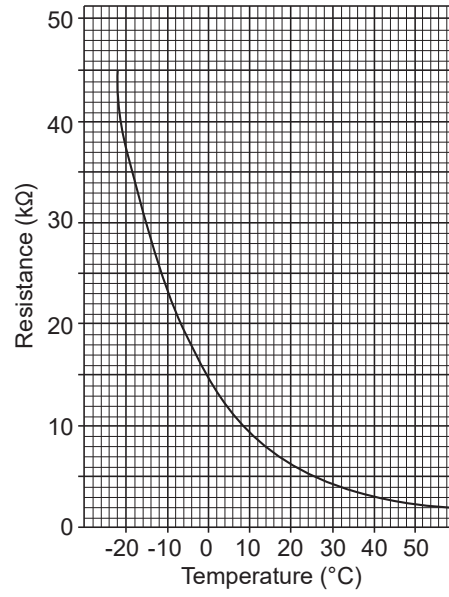

- Boiler flow temperature thermistor (THWB1)
- Mixing tank temperature thermistor (THW10)

Thermistor R100 = 3.3 kΩ ± 2%
 B constant = 3970 ± 1%

$$R_t = 3.3 \exp \left\{ 3970 \left(\frac{1}{273+t} - \frac{1}{273} \right) \right\}$$

0°C	162.8 kΩ
10°C	97.4 kΩ
20°C	60.3 kΩ
25°C	48.1 kΩ
30°C	38.6 kΩ
40°C	25.4 kΩ
50°C	17.1 kΩ
60°C	11.9 kΩ
70°C	8.4 kΩ
80°C	6.0 kΩ

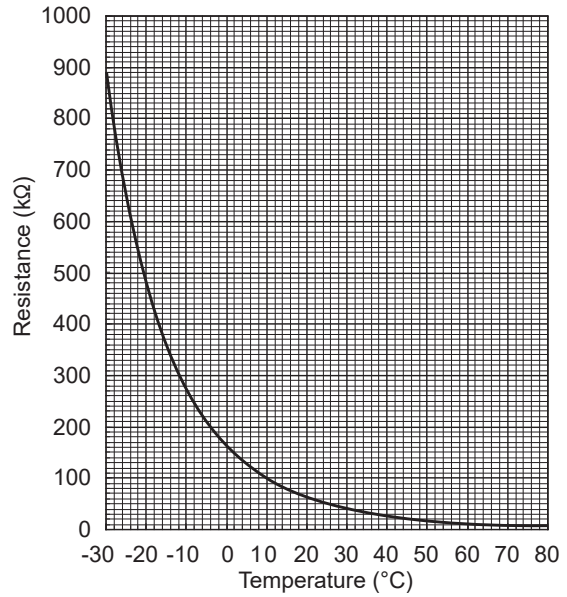

10-7. Test point diagram

FTC (Controller board)

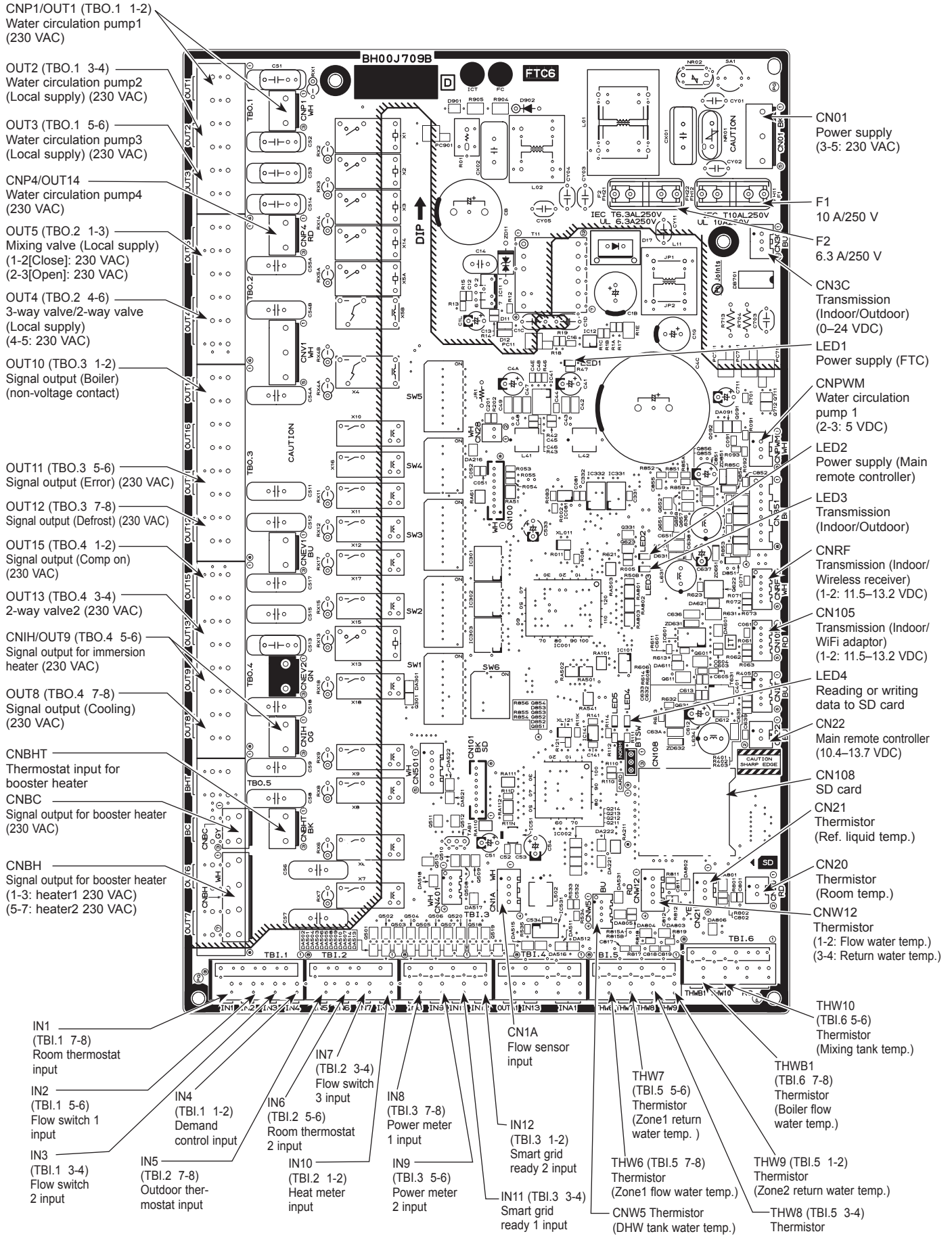

<Preparation for the repair service>

- Prepare the proper tools.
- Prepare the proper protectors.
- Provide adequate ventilation.
- After stopping the operation of the hydrobox and outdoor unit, turn off all the power-supply breaker.
- Discharge the condenser before the work involving the electric parts.
- Allow parts to cool.
- Do not expose the electric parts to water.
- When replacing or servicing water circuit parts, drain system first.

Check individual illustrations and positions of the parts by referring to the parts catalogue.

Some lead wires and pipes are bundled with Bands. Cut the bands to undo the fastened pipes and lead wires if necessary. When bundling the lead wires and pipes again, use new commercially available bands.

When removing the parts associated with water pipe work, drain the hydrobox as necessary. (Refer to "Draining the Hydrobox" on page 21.)

When draining the hydrobox, keep water from splashing on the internal parts (mainly electric parts and insulations).

—————> : Indicates the visible parts in the photos/figures.

-----> : Indicates the invisible parts in the photos/figures.

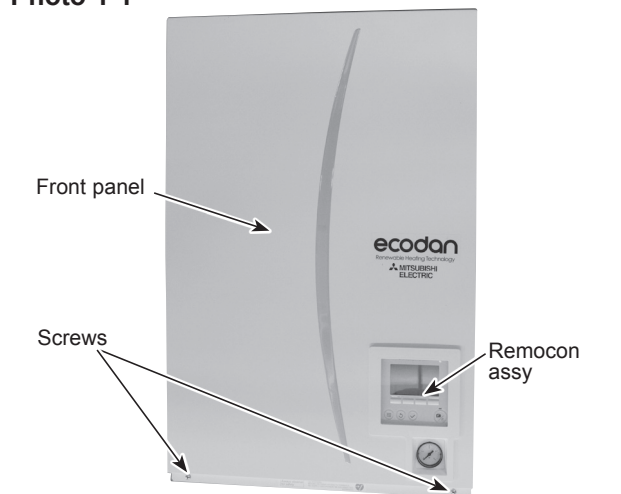
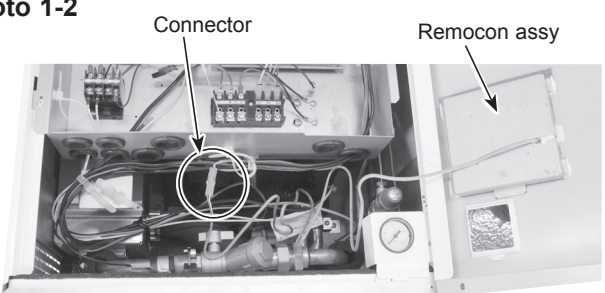
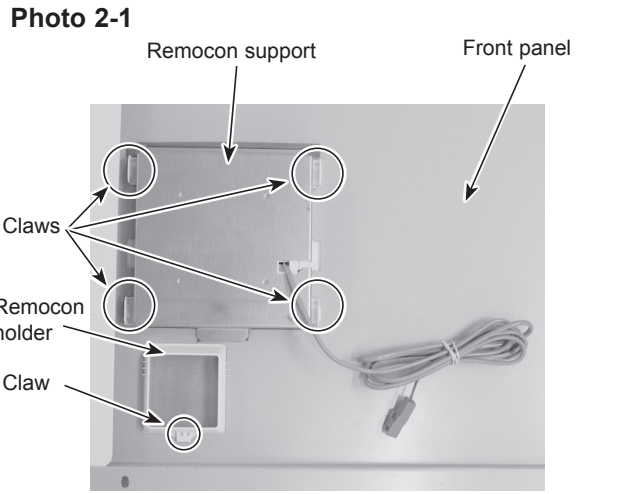
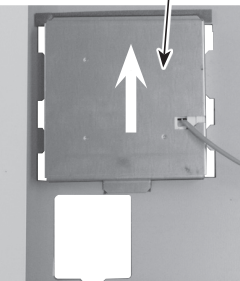
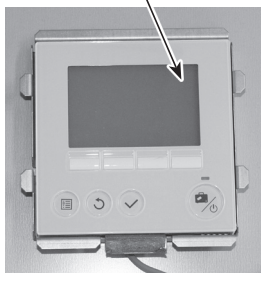
DISASSEMBLY PROCEDURE	PHOTOS/ FIGURES
<p>1. How to remove the front panel</p> <p>(1) Remove the 2 screws at the bottom of the hydrobox. (Photo 1-1)</p> <p>(2) Slightly lift and pull out the front panel from the hydrobox. (Photo 1-1)</p> <p>(3) Disconnect the relay connector connecting from the remocon assy. (Photo 1-2)</p>	<p>Photo 1-1</p>  <p>Front panel</p> <p>Screws</p> <p>Remocon assy</p>
<p>Photo 1-2</p>  <p>Connector</p> <p>Remocon assy</p>	<p>Photo 2-1</p>  <p>Remocon support</p> <p>Front panel</p> <p>Claws</p> <p>Remocon holder</p> <p>Claw</p>
<p>2. How to remove the remocon assy</p> <p>(1) Remove the front panel. (Refer to Procedure 1.)</p> <p>(2) Turn the front panel over and remove the 5 claws at the remocon holder. (Photo 2-1)</p> <p>(3) Slide the remocon support upward, then remove it together with the main remote controller. (Photo 2-2)</p> <p>(4) Separate the remocon assy from the remocon support. (Photo 2-3)</p>	<p>Photo 2-2</p>  <p>Remocon support</p> <p>Photo 2-3</p>  <p>Remocon assy</p>

DISASSEMBLY PROCEDURE

3. How to remove the electrical parts

(Steps (1) through (3) are applied to all the following parts.)

- (1) Remove the front panel. (Refer to Procedure 1.)
- (2) Remove the 4 screws holding the control box. (Photo 3-1)
- (3) Slightly lift and pull out the control box. (Photo 3-1)

<Earth leakage circuit breaker> (Photo 3-2)

- (4) Disconnect all the lead wires from the earth leakage circuit breaker.
 - (5) Remove the 2 screws on the earth leakage circuit breaker.
- Note: To avoid dropping of the breaker, hold the breaker by hand when removing the last screws.

<Contactor> (Photo 3-2)

- (4) Disconnect all the lead wires from the contactors.
 - (5) Remove the 2 screws on each contactor.
- Note: To avoid dropping of the contactors, hold the contactors by hand when removing the last screws.
To prevent an electrical shock, wait until all the LED lamps on the FTC control board are turned off.

<Terminal block> (Photo 3-2)

- (4) Disconnect all the lead wires from the terminal block. (To disconnect the S1, S2 and S3 lead wires, disengage the locks by pressing on the claws.)
 - (5) Remove the screw on the terminal block.
- Note: To avoid dropping of the terminal block, hold the terminal block by hand when removing the screw.

<Controller board> (Photo 3-3)

- (4) Disconnect all the lead wires from the controller board.
- (5) Remove the controller board from the 4 board supports.

PHOTOS/ FIGURES

Photo 3-1

Control box fixing screws

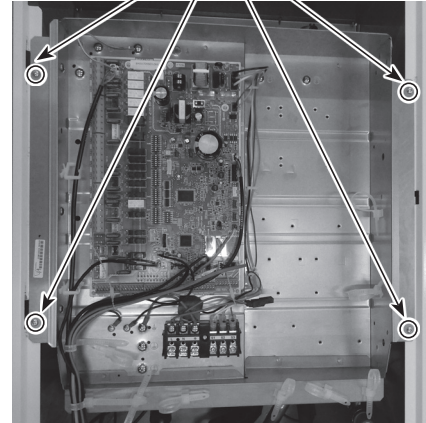

Note: The photo shown is of the EHSD-MED.UK model.

Photo 3-2

Controller board Earth leakage circuit breaker (ECB1) Control box

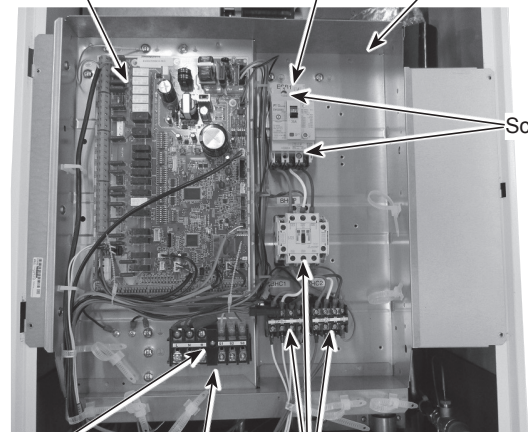

Screw Terminal block (TB1) Contactors

Note: The photo shown is of the ERSE-YM9ED.UK model.

Photo 3-3

Board supports

Controller board

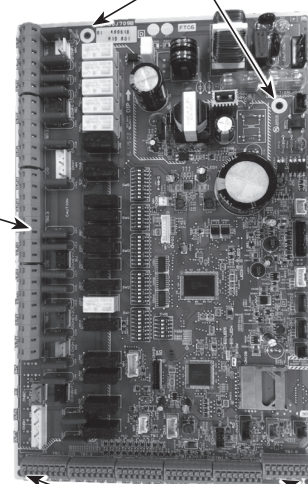

Board supports

DISASSEMBLY PROCEDURE

4. How to swing the control box to the front

- (1) Remove the front panel. (Refer to Procedure 1.)
- (2) Remove the 2 screws from the control box bracket (R) and the 2 screws from the control box bracket (L). (Photo 4-1 and 4-2)
- (3) Disengage the control box bracket (R) from the right-hand side panel and pull the control box. At this point, lifting slightly and pulling the control box will swing the control box to the front. (Photo 4-3)

Note: Disconnect the field wiring as necessary.

PHOTOS/ FIGURES

Photo 4-1

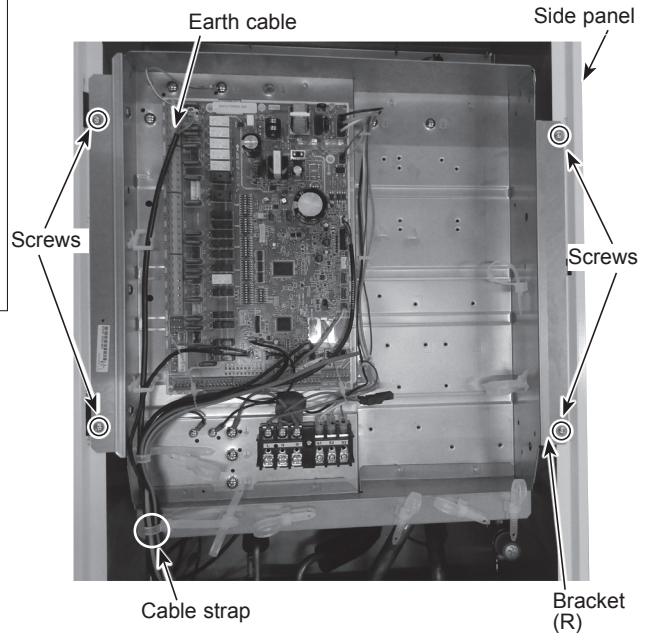

Note: The photo shown is of the EHSD-MED.UK model.

Photo 4-2

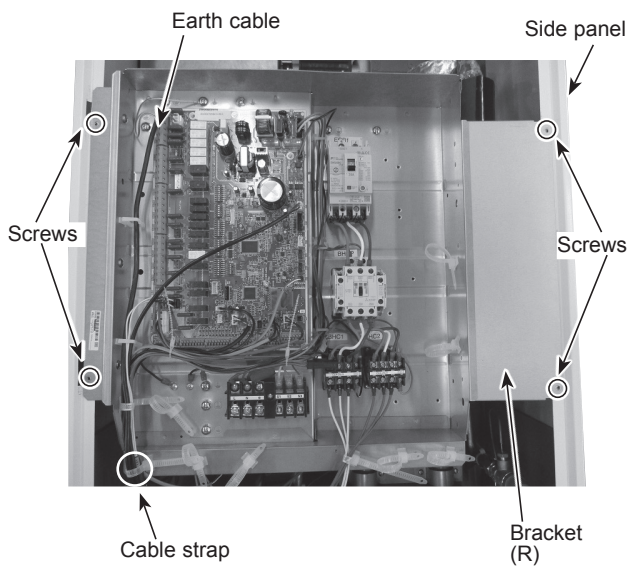

Note: The photo shown is of the ERSE-YM9ED.UK model.

Photo 4-3

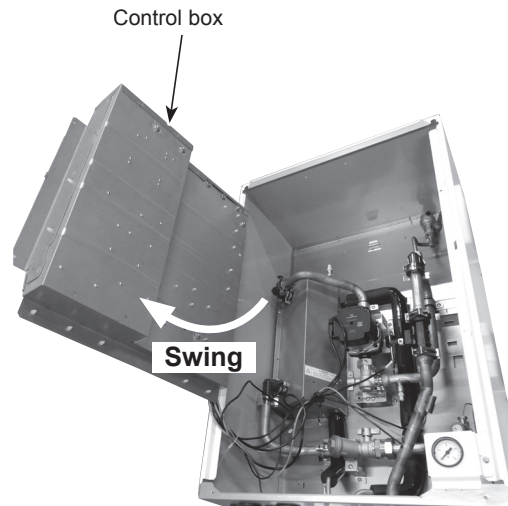

DISASSEMBLY PROCEDURE

5. How to remove water pump/ pump valve <Water pump>

Close the pump valve (OFF) before removing the water pump, and open the valves (ON) after reinstalling the water pump.

- (1) Remove the front panel. (Refer to Procedure 1.)
- (2) Disconnect the CNP1 connector, the earth cable, and the CNPWM connector on the controller board. (Photo 5-1)
- (3) <E*SC/D series>

Release the water pump lead wire from the fastener, the 2 cable clamps and the 2 cable straps. Feed the lead wire out the control box without putting strain on the CNP1 and the CNPWM connectors. (Photo 5-1)

<E*SE series and E*PX series>

Release the water pump lead wire from the fastener, the 2 cable clamps and the cable strap. Feed the lead wire out the control box without putting strain on the CNP1 and the CNPWM connectors. (Photo 5-1)

- (4) Swing the control box to the front. (Refer to Procedure 4.)
- (5) <E*SC/D series>

Close (OFF) the pump valve and remove the G1" nuts using 2 spanners: one to hold the G1" nut and the other to turn the other side of G1" nut.

Remove the water pump by sliding it horizontally. (Photo 5-2)

- When the pump valve handle is stiff, turn the handle 90 degrees clockwise mainly by using a spanner.
- When reinstalling the G1" nuts, use new G1" gaskets. (Photo 5-3)
- Set the water pump in the way that the die stamped arrow facing down, and the lead wire connectors facing to the left. (Photo 5-2)
- Be sure to change the pump and the water pump lead wire together.
- Be sure to wipe water around the surface of the pump and the water pump lead wire thoroughly.

PHOTOS/ FIGURES

Photo 5-1

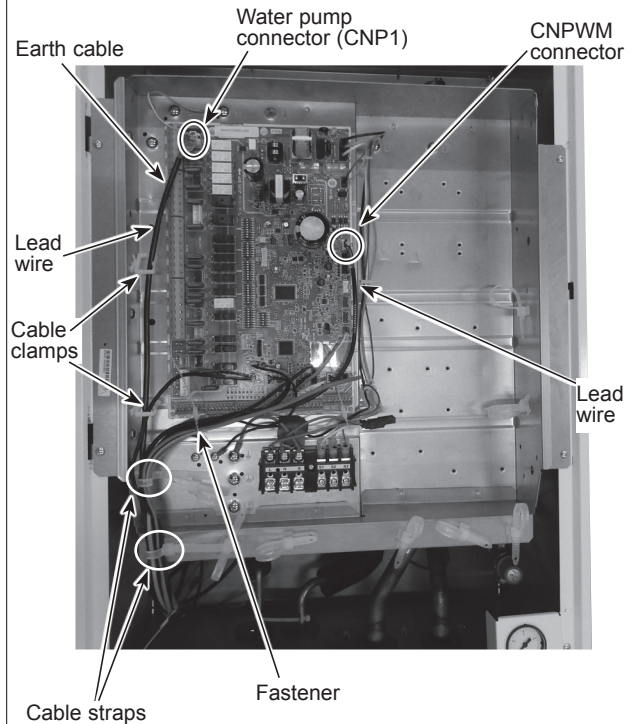

Photo 5-2 (E*SC/D series)

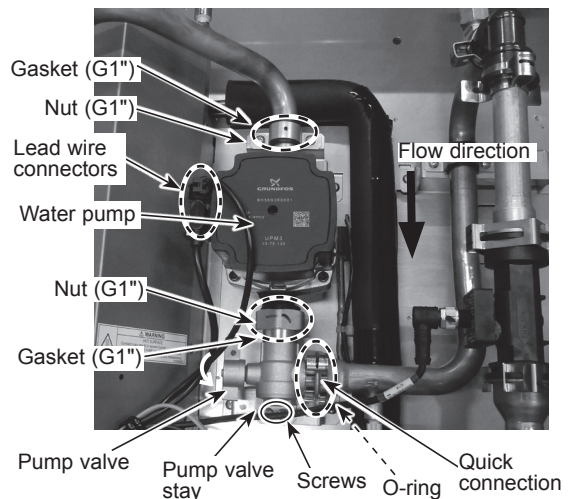
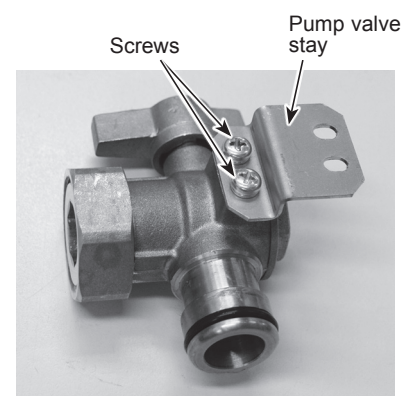

Photo 5-3 (E*SC/D and E*PX series)



Photo 5-4 (E*SC/D and E*PX series)



DISASSEMBLY PROCEDURE

5. How to remove water pump/ pump valve

(5) <E*SE series>

Close (OFF) the pump valve and remove the G1-1/2" nuts using 2 spanners: one to hold the G1-1/2" nut and the other to turn the other side of G1-1/2" nut. Remove the water pump by sliding it horizontally. (Photo 5-5)

- When the pump valve handle is stiff, turn the handle 90 degrees clockwise mainly by using a spanner.
- When opening or closing the pump valve, ensure to do so fully, not halfway.
- When reinstalling the G1-1/2" nuts, use new G1-1/2" gaskets. (Photo 5-6)
- Set the water pump in the way that the die stamped arrow facing down, and the terminal box facing to the left. (Photo 5-5)
- Be sure to change the pump and the water pump lead wire together.
- Be sure to wipe water around the surface of the pump and the water pump lead wire thoroughly.

<E*PX series>

Close (OFF) the pump valve and remove the G1" nuts using 2 spanners: one to hold the G1" nut and the other to turn the other side of G1" nut.

Remove the water pump by sliding it vertically. (Photo 5-8)

- When the pump valve handle and the strainer valve handle are stiff, turn the handle 90 degrees clockwise mainly by using a spanner.
- When opening or closing the pump valve and the strainer valve, ensure to do so fully, not halfway.
- When reinstalling the G1" nuts, use new G1" gaskets. (Photo 5-3)
- Set the water pump in the way that the die stamped arrow facing left, and the lead wire connectors facing to the up. (Photo 5-8)
- Be sure to change the pump and the water pump lead wire together.
- Be sure to wipe water around the surface of the pump and the water pump lead wire thoroughly.

<Pump valve>

(6) Remove the 2 screws fixing the pump valve stay. (Photos 5-2, 5-5 and 5-8)

(7) Remove the pump valve by detaching the quick connection. (Photos 5-2, 5-5 and 5-8)

- When reinstalling the quick connection, use new O-ring.
- When the pump valve handle is stiff, turn the handle 90 degrees clockwise mainly by using a spanner.
- When reinstalling the pump valve, place the handle to the left hand side of the pump valve.
- When opening or closing the pump valve, ensure to do so fully, not halfway.
- Reuse the removed pump valve stay and the pump valve stay fixing screws. (Photos 5-4 and 5-7)
- Refer to Procedure 16 for how to attach and detach the quick connection.

Note: Skip Steps (2) and (3) above when replacing the pump valves only.

PHOTOS/ FIGURES

Photo 5-5 (E*SE series)

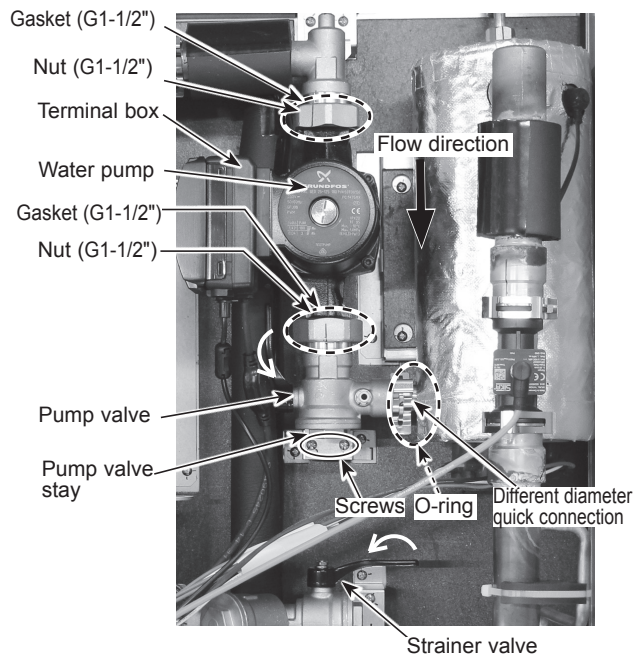

Photo 5-6 (E*SE series) Photo 5-7 (E*SE series)

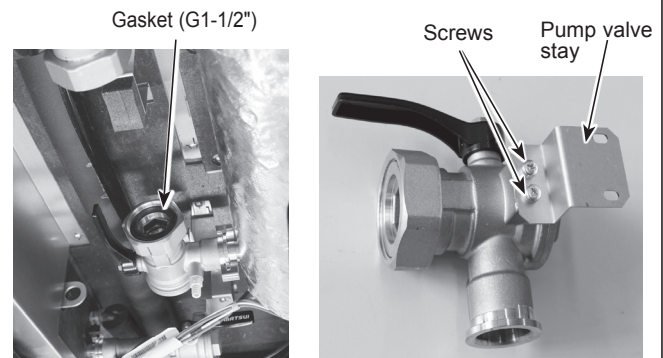
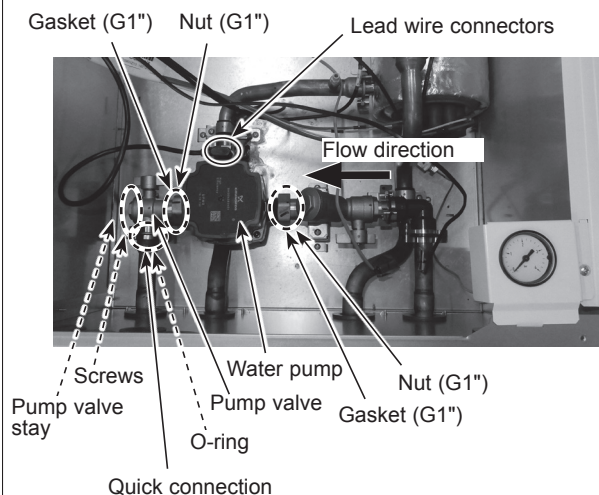

Photo 5-8 (E*PX series)



DISASSEMBLY PROCEDURE

6. How to remove the flow sensor

- (1) Remove the front panel. (Refer to Procedure 1.)
- (2) Disconnect the CN1A connector on the controller board. (Photo 6-1)
- (3) Release the flow sensor lead wire from the fastener and the 2 cable straps. Feed the lead wire out the control box without putting strain on the CN1A connector. (Photo 6-1)
- (4) Swing the control box to the front. (Refer to Procedure 4.)
- (5) Remove the flow sensor by detaching the same diameter quick connection. (Photo 6-2)

- When reinstalling the flow sensor, use new O-rings. (Photo 6-3)
- <E*SC/D series and E*PX series>
Set the flow sensor in the orientation of the arrow printed on the flow sensor and in the way that the sensor part faces to the left. (Photo 6-2)
- <E*SE series>
Set the flow sensor in the orientation of the arrow printed on the flow sensor and in the way that the sensor part faces to the front.
- Refer to Procedure 16 for how to attach and detach the quick connection.

PHOTOS/ FIGURES

Photo 6-1

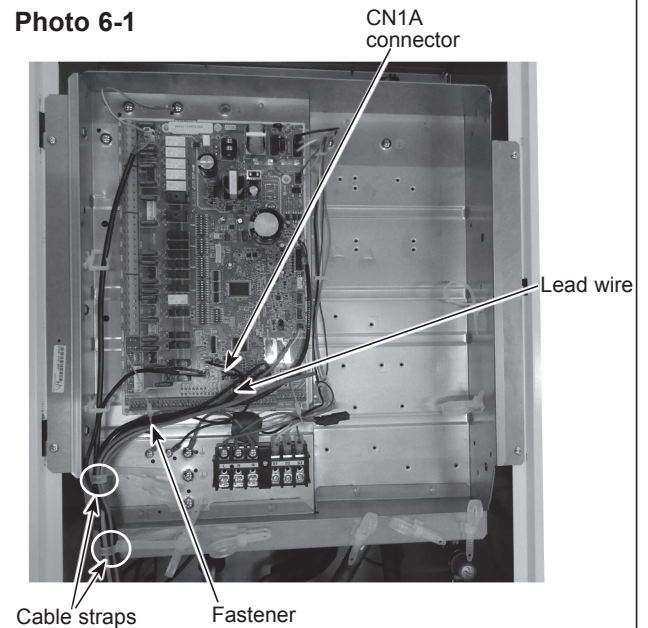
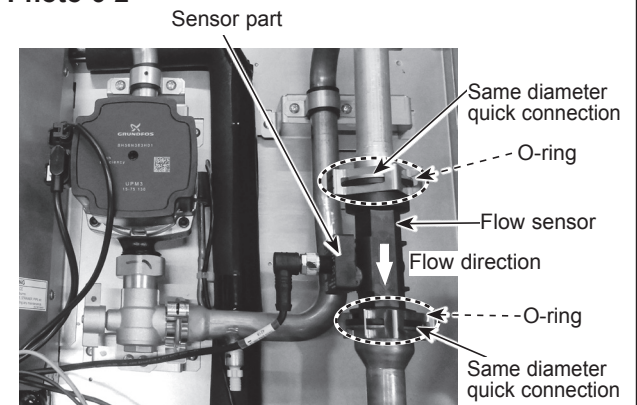
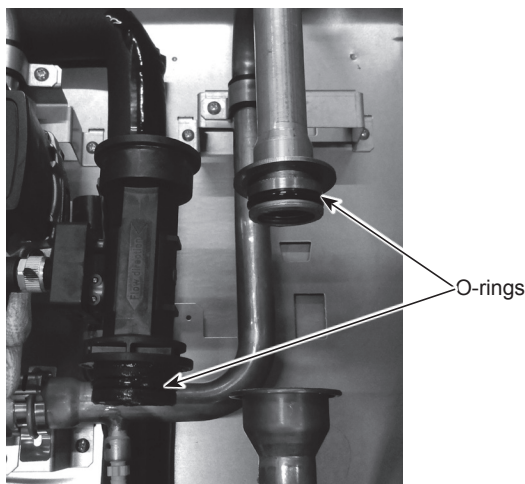

Photo 6-2



Note: The photo shown is of the EHSD-MED.UK model.

Photo 6-3



7. How to remove the booster heater

(Steps (1) through (4) are applied to all the following units.)

- (1) Remove the front panel. (Refer to Procedure 1.)
- (2) Disconnect the booster heater lead wires from the CNBHT connector on the controller board and from the BHC1 (Lead wire No.1, No.2 and No.3) and BHC2 (Lead wire No.4, No. 5 and No.6) contactors respectively. (Photo 7-1)
- (3) Release the booster heater lead wire from the 2 cable straps. Feed the lead wires put the control box without putting strain on the CNBHT connector, the BHC1 and BHC2 contactors. (Photo 7-1)
- (4) Swing the control box to the front. (Refer to Procedure 4.)

Note: Do not mix up the lead wire numbers when re-connecting the lead wires to the contactors as the lead wire numbers are different depending on the models.

Photo 7-1

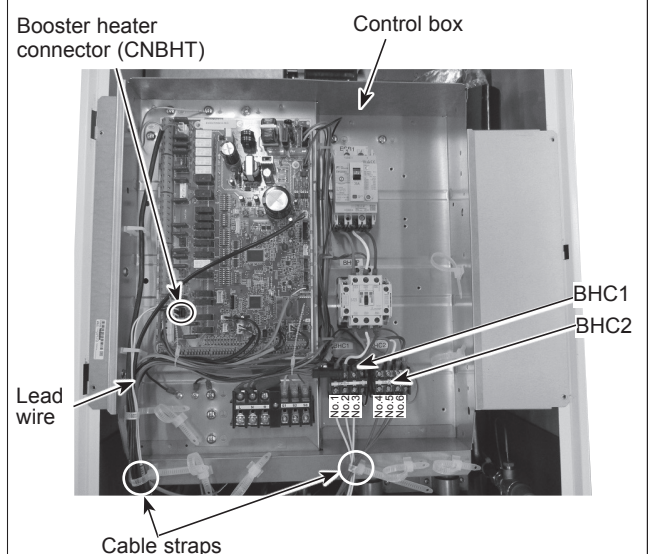

Note: The photo shown is of the ERSE-YM9ED.UK model.

DISASSEMBLY PROCEDURE

7. How to remove the booster heater

Model	Lead wire No.	Contactors
EHSC-VM2D	ERSC-VM2D	No.1 BHC1-U
EHSD-VM2D	ERSD-VM2D	No.2 BHC1-V
EHPX-VM2D	ERPX-VM2D	
EHSC-VM6D	ERSC-VM6D	No.1 BHC1-U
EHPX-VM6D	ERSD-VM6D	No.2 BHC1-V
ERSC-VM6D	ERPX-VM6D	No.4 BHC2-U
		No.5 BHC2-V
EHSC-YM9D	EHSC-YM9ED	No.1 BHC1-U
EHSC-TM9D	EHSD-YM9C	No.2 BHC1-V
EHSD-YM9ED	EHSD-TM9D	No.3 BHC1-W
EHSE-YM9ED	ERSE-YM9ED	No.4 BHC2-U
EHPX-YM9D	EHPX-YM9ED	No.5 BHC2-V
ERSD-YM9D	ERSC-YM9D	No.6 BHC2-W
ERPX-YM9D		

Refer to 6. WIRING DIAGRAM

<E*S* series and E*PX series>

- (5) <Only E*SC/D series>
Remove the pump valve. (Refer to Procedure 5.)
- (6) Remove the flow sensor. (Refer to Procedure 6.)
- (7) Remove the L joint and the pipe (B.H.-F.S.) by detaching the quick connection. (Photos 7-2 and 7-3)
 - When reinstalling the quick connection, use new O-ring.
 - Refer to Procedure 16 for how to attach and detach the quick connection.
- (8) Remove the flare nut. (Photos 7-2 and 7-3)
- (9) <Only E*SC/D series>
Remove the pipe (PUMP-B.H.) by detaching the quick connection. (Photo 7-2)
<Only E*PX series>
Remove the pipe (OUT-B.H.) by detaching the quick connection. (Photo 7-3)
 - When reinstalling the quick connection, use new O-ring.
 - Refer to Procedure 16 for how to attach and detach the quick connection.
- (10) <Only E*PX series>
Remove the saddle band and the rubber tube by removing the 2 screws on the saddle band. (Photo 7-3)
- (11) Remove the 2 screws that hold the heater stay onto the back panel. Lift the booster heater slightly and remove the booster heater with the heater stay from the back panel. (Photos 7-2, 7-3 and 7-4)
- (12) Remove the 2 screws on the back of the heater stay and remove the heater stay from the booster heater. (Photo 7-4)
 - Reuse the removed heater stay and the screws.

Photo 7-4

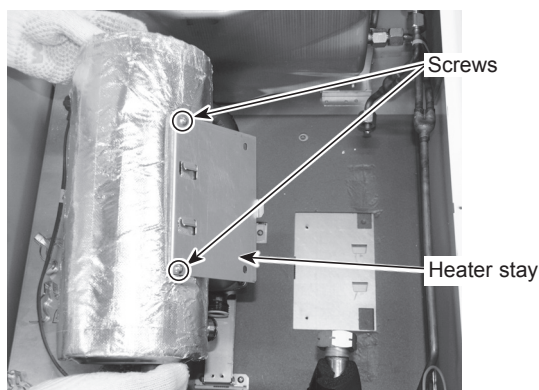

PHOTOS/ FIGURES

Photo 7-2 (E*S* series)

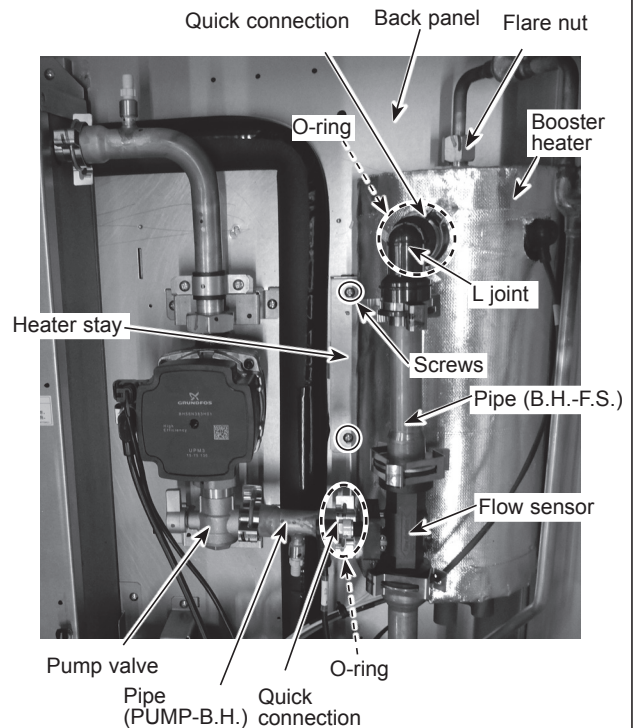

Note: The photo shown is of the EHSC-VM2ED.UK model.

Photo 7-3 (E*PX series)

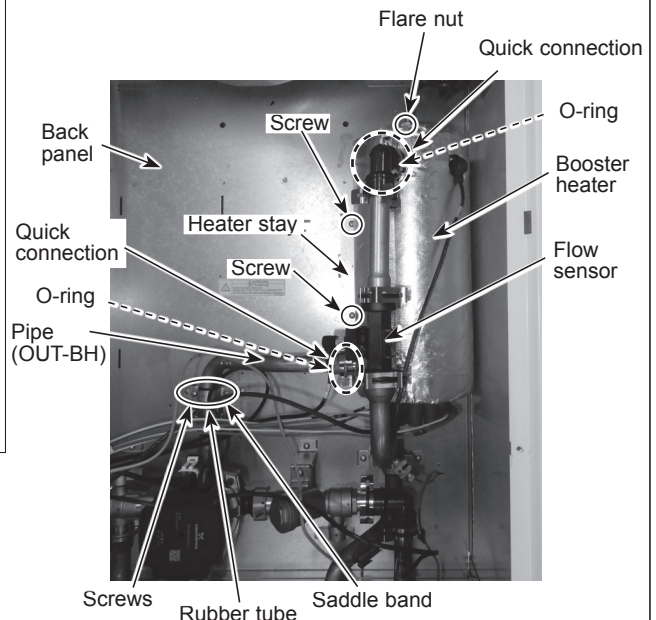

DISASSEMBLY PROCEDURE

PHOTOS/ FIGURES

8. How to remove the plate heat exchanger

(Steps (1) through (9) are applied to the following E*SC/D series.)

- (1) Pump down the refrigerant circuit and close the stop valve on the outdoor unit. (Refer to "12. Supplementary information".)
- (2) Remove the front panel. (Refer to Procedure 1.)
- (3) Swing the control box to the front. (Refer to Procedure 4.)
- (4) Release the lead wires from the coated clamp. (Photo 8-1)
- (5) Close the strainer valve (OFF). (Photos 8-1, 8-5 and 8-7)
 - When the strainer valve handle is stiff, turn the handle 90 degrees clockwise mainly by using a spanner.
 - When opening or closing the strainer valve, ensure to do so fully, not halfway.
- (6) Remove the water pump and the pump valve. (Refer to Procedure 5.)
- (7) Remove the expansion vessel. (Refer to Procedure 12.)
- (8) Remove the saddle band (upper the pump) and the rubber tube by removing the 2 screws on the saddle band. (Photo 8-1)
- (9) Remove the pipe (W.C.-PUMP) by detaching the quick connection. (Photos 8-1 and 8-5)
 - When reinstalling the quick connection, use a new O-ring.
 - Refer to Procedure 16 for how to attach and detach the quick connection.
- (10) Remove the flare nuts on the gas and liquid pipes under the hydrobox using 2 spanners: one to hold each flare joint and the other to turn each flare nut.

Photo 8-1 (E*SC series)

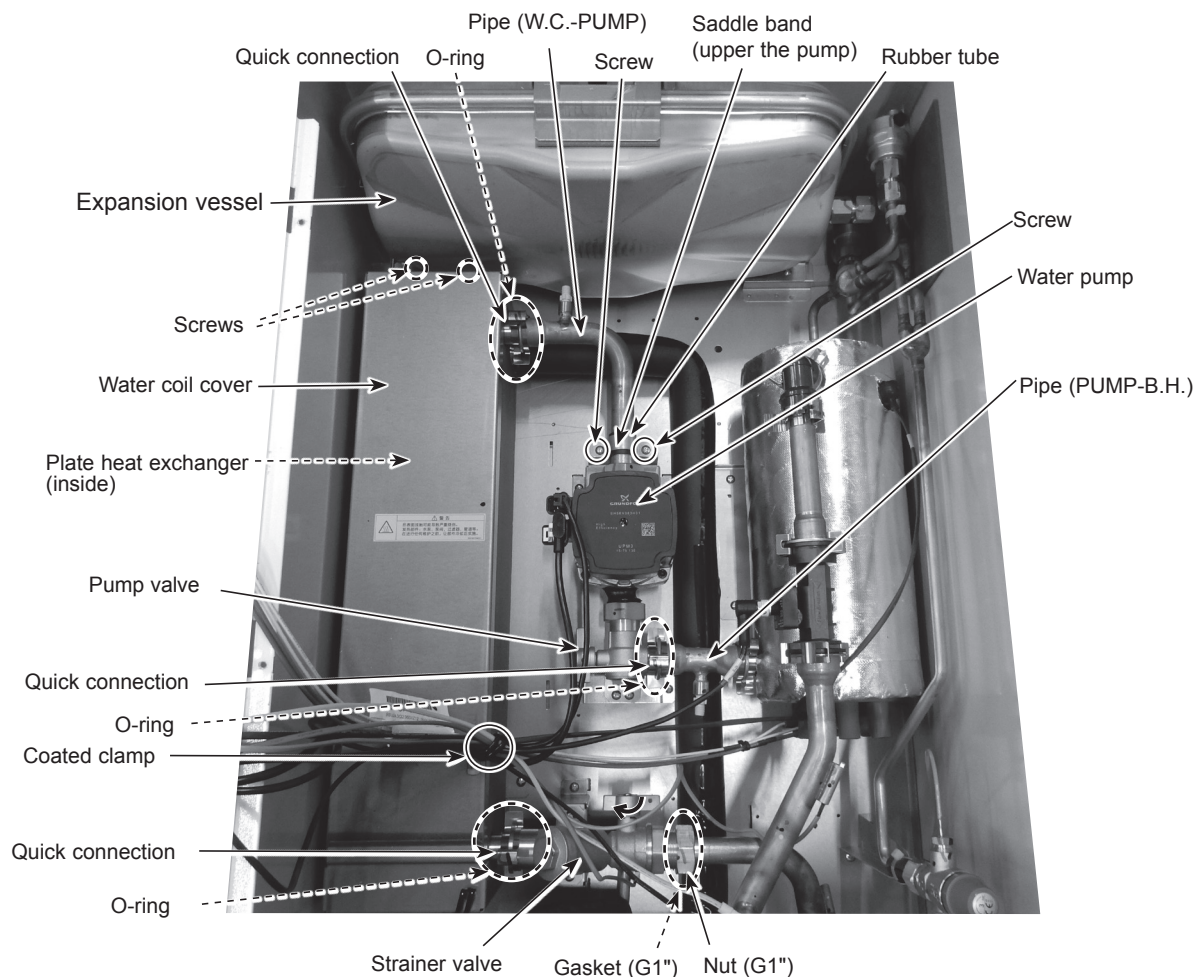

DISASSEMBLY PROCEDURE

8. How to remove the plate heat exchanger (continued) <E*SC series>

- (11) Remove the G1" nut on the water outlet side of the strainer valve using 2 spanners: one to hold the strainer valve and the other to turn the G1" nut. (Photos 8-1 and 8-4)
 - When reinstalling the G1" nut, use a new G1" gasket.
- (12) <Only EHSC series>
Remove the 2 screws on the strainer valve stay. (Photo 8-4)
- (13) <ERSC series>
Remove the pipe (STR-W.C.) by detaching the quick connection from the plate heat exchanger. (Photo 8-4)
<EHSC series>
Remove the strainer valve by detaching the quick connection from the plate heat exchanger. (Photo 8-1)
 - When reinstalling the quick connections, use a new O-ring.
 - Refer to Procedure 16 for how to attach and detach the quick connection.
- (14) Remove the TH2 thermistor from the thermistor holder. (Refer to Procedure 14. Photos 14-2 and 14-3)
- (15) Remove the water coil cover by removing the 2 screws. (Photo 8-1)
- (16) Pull out the plate heat exchanger from the hydrobox by lifting it upward. (Photos 8-2 and 8-3)

PHOTOS/ FIGURES

Photo 8-2 (EHSC series)

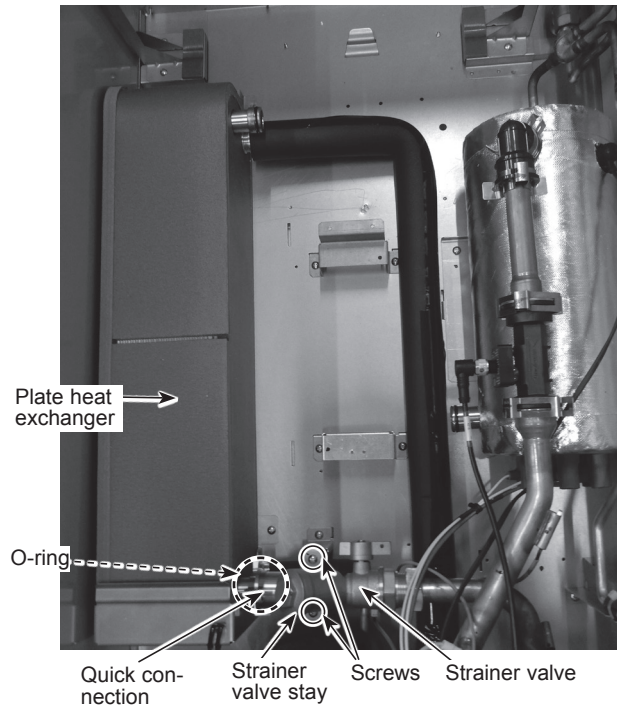

Photo 8-3

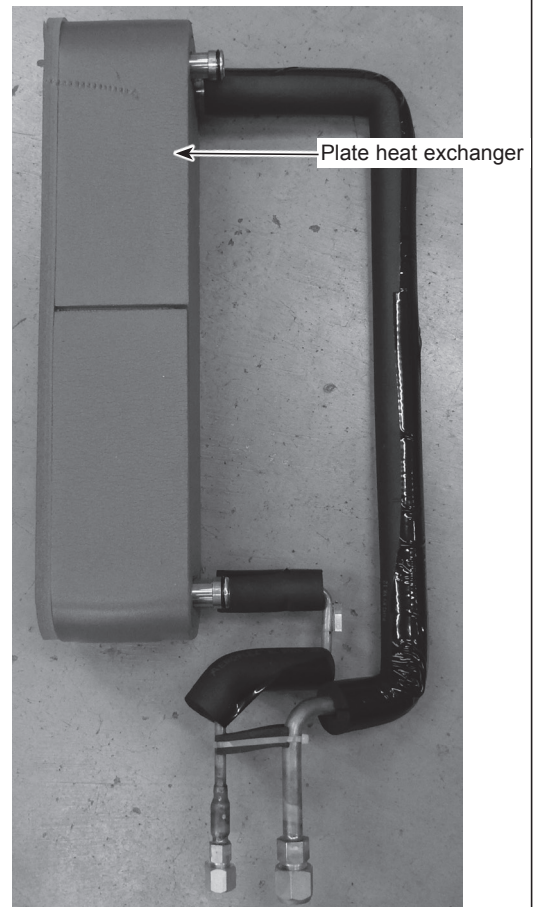
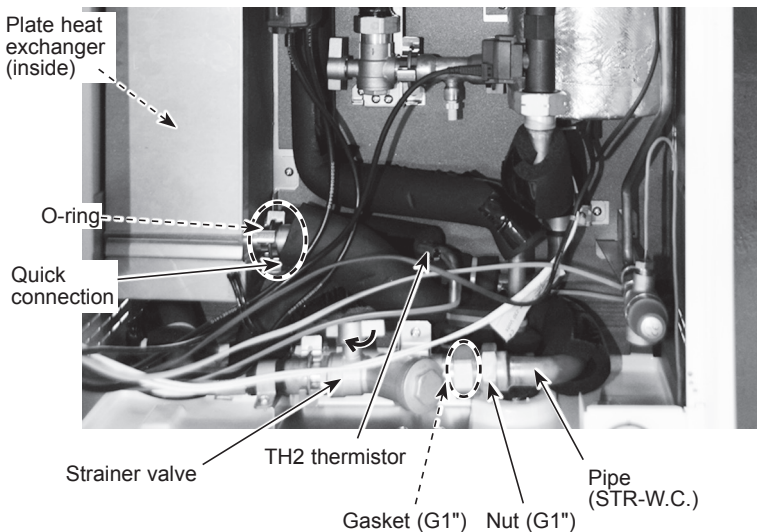

Photo 8-4 (ERSC series)



DISASSEMBLY PROCEDURE

8. How to remove the plate heat exchanger (continued) <E*SD series>

- (11) <Only ERSD series>
Remove the saddle band (upper the strainer) and the rubber tube by removing the 2 screws on the saddle band.
- (12) Detach the quick connection for the L joint (Lower), the plate heat exchanger, and rotate forward the pipe (STR-W.C.) with the L joint (lower) by using the quick connection (upper the strainer) as a fulcrum.
- When reinstalling the quick connection, use a new O-ring.
 - Refer to Procedure 16 for how to attach and detach the quick connection.
- (13) Remove the TH2 thermistor from the thermistor holder.
(Refer to Procedure 14. Photos 14-2 and 14-3)
- (14) Remove the plate heat exchanger with water coil cover by lifting it upward after removing the 2 screws on the water coil cover. (Photo 8-5)
- (15) Remove the water coil cover and the water coil base by removing the 4 screws. (Photo 8-6)

PHOTOS/ FIGURES

Photo 8-6 (E*SD series)

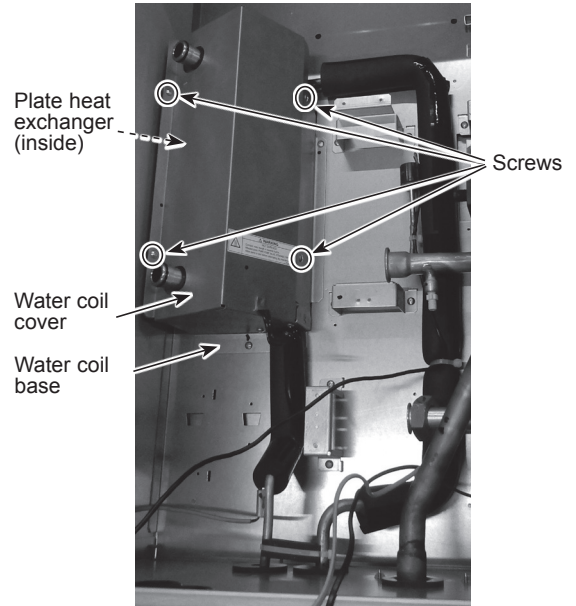
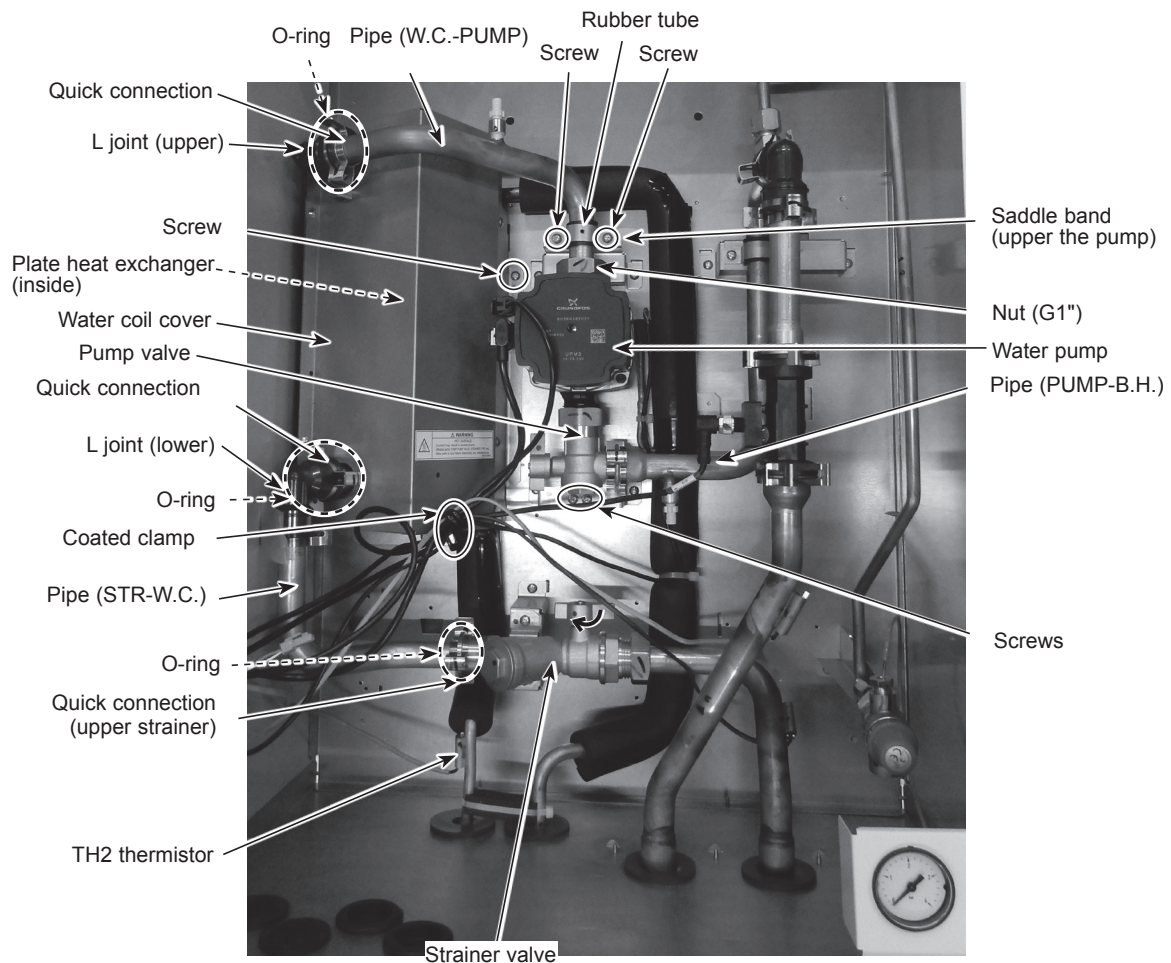

Photo 8-5 (E*SD series)



DISASSEMBLY PROCEDURE

PHOTOS/ FIGURES

8. How to remove the plate heat exchanger (continued) <E*SE series>

- (1) Pump down the refrigerant circuit and close the stop valve on the outdoor unit. (Refer to "12. Supplementary information".)
- (2) Remove the front panel. (Refer to Procedure 1.)
- (3) Swing the control box to the front. (Refer to Procedure 4.)
- (4) Release the lead wires from the coated clamp. (Photo 8-7)
- (5) Close the strainer valve (OFF). (Photo 8-7)
 - When the strainer valve handle is stiff, turn the handle 90 degrees clockwise mainly by using a spanner. (Photo 8-7)
 - When opening or closing the strainer valve, ensure to do so fully, not halfway.
- (6) Remove the water pump and the pump valve. (Refer to Procedure 5.)
- (7) Remove the joint (WC-PUMP) by removing the 2 screws, and detaching the different diameter quick connection. (Photo 8-7)
 - When reinstalling the different diameter quick connection, use a new O-ring.
 - Refer to Procedure 16 for how to attach and detach the quick connection.

Photo 8-7

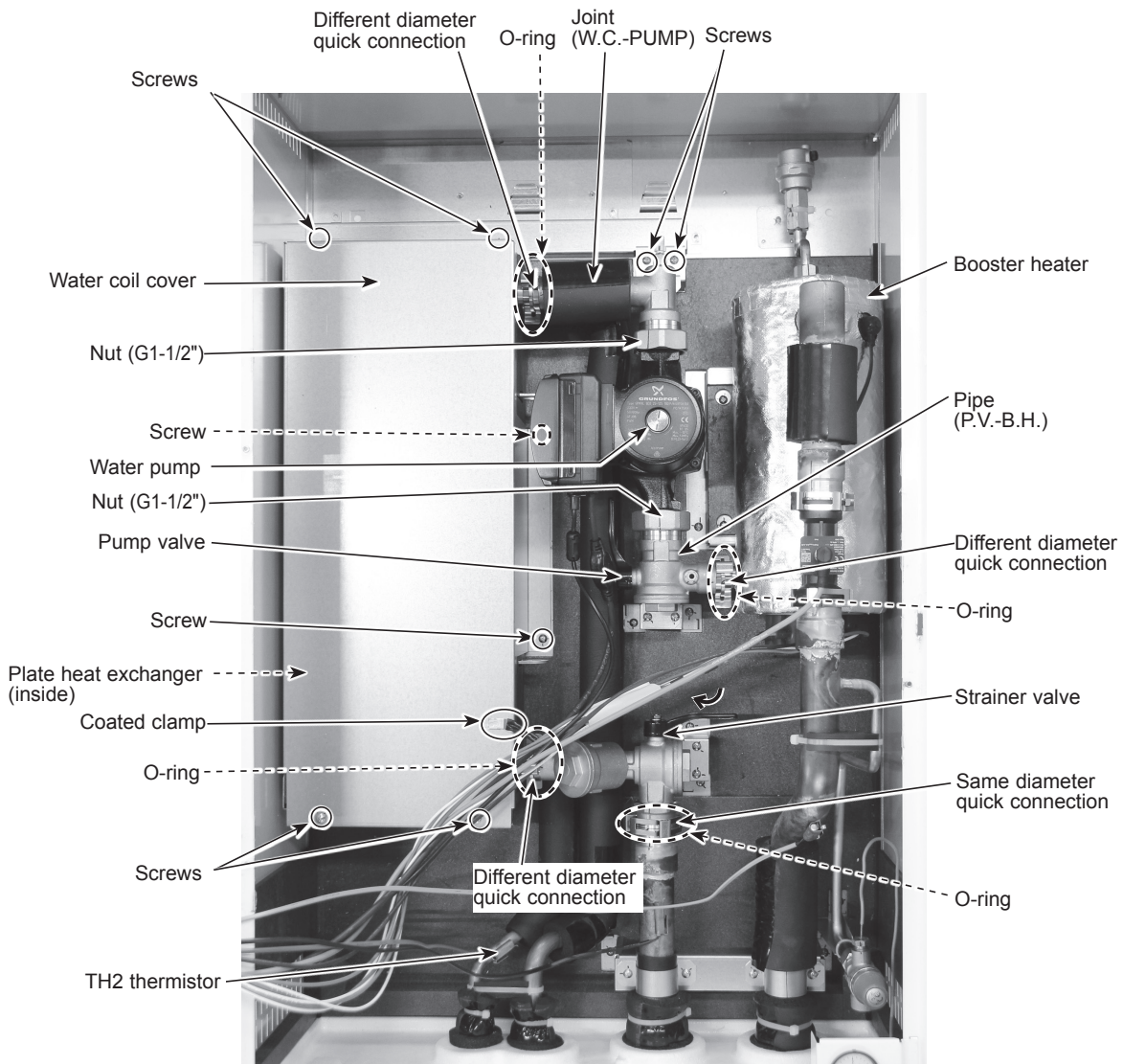

DISASSEMBLY PROCEDURE

8. How to remove the plate heat exchanger (continued)

- (8) Remove the strainer valve by removing the 2 screws, and detaching the same diameter quick connection. (Photo 8-8)
 - When reinstalling the same diameter quick connection, use a new O-ring.
 - Refer to procedure 16 for how to attach and detach the quick connection.
- (9) Remove the flare nuts on the gas and liquid pipes under the hydrobox using 2 spanners: one to hold each flare joint and the other to turn each flare nut.
- (10) Remove the TH2 thermistor from the thermistor holder. (Photo 8-7 and refer to Procedure 14. Photo 14-2)
- (11) Remove the water coil cover by removing the 6 screws. (Photo 8-7)
- (12) Pull out the plate heat exchanger from the hydrobox by lifting it upward. (Photos 8-9 and 8-10)
- (13) Remove the strainer valve by detaching the different diameter quick connection from the plate heat exchanger. (Photos 8-8 and 8-9)
 - When reinstalling the different diameter quick connection, use a new O-ring.
 - Refer to Procedure 16 for how to attach and detach the quick connection.

PHOTOS/ FIGURES

Photo 8-8

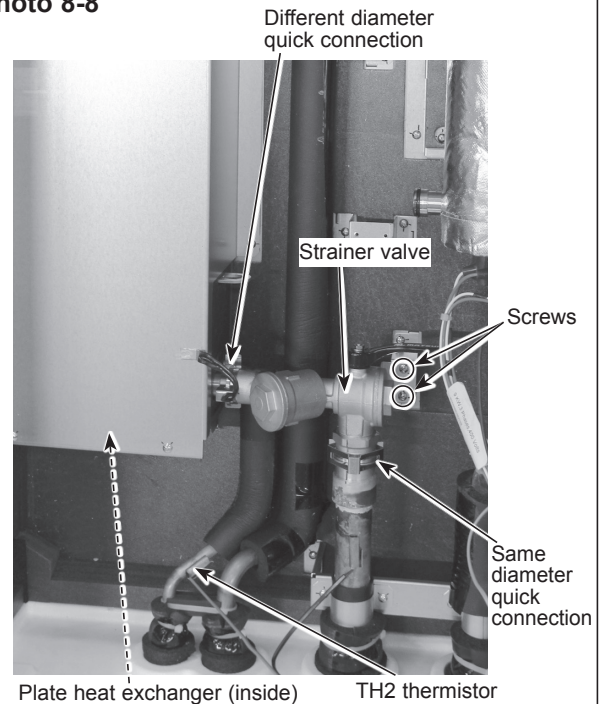

Photo 8-10

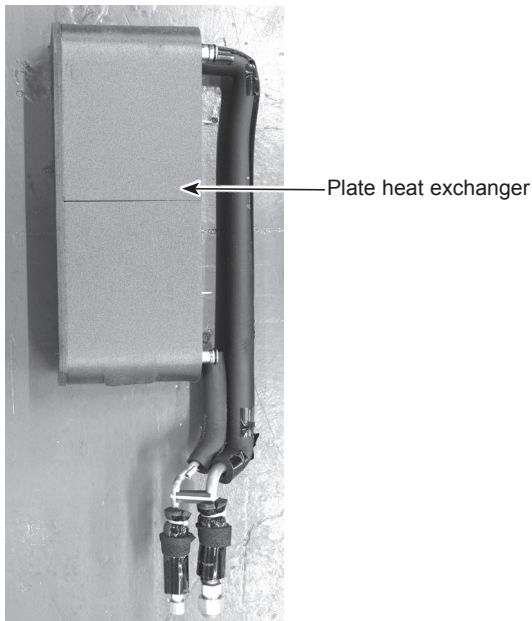
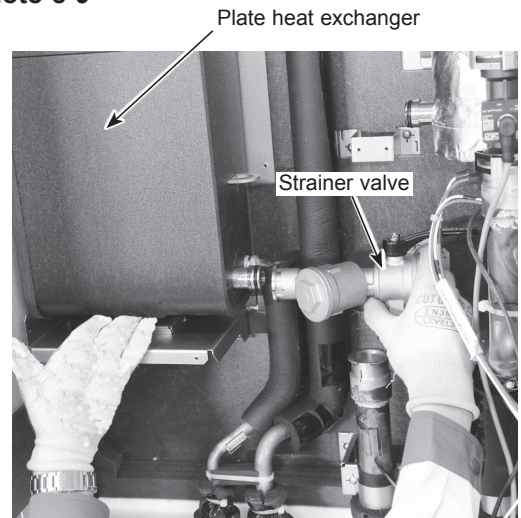

Photo 8-9



9. How to remove the pressure sensor

<Only E*SD series>

- (1) Remove the plate heat exchanger. (Refer to Procedure 8.)
 - (2) Remove the band. (Photo 9.)
 - (3) Remove the welded part of the pressure sensor. Be sure not to burn the pipe cover. (Photo 9.)
- Note: The temperature of the pressure sensor must be 100 °C or below when welding.

Photo 9

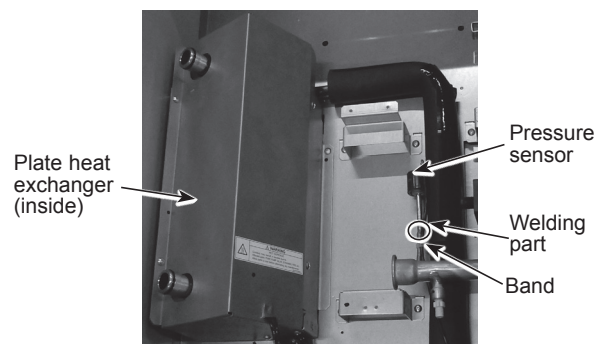

DISASSEMBLY PROCEDURE

10. How to remove the strainer

- (1) Remove the front panel. (Refer to Procedure 1.)
- (2) Swing the control box to the front. (Refer to Procedure 4.)
- (3) Close the strainer valve (OFF). (Photos 10-1, 10-4 and 10-6)
 - When the strainer valve handle is stiff, turn the handle 90 degrees clockwise mainly by using a spanner.
 - When opening or closing the strainer valve, ensure to do so fully, not halfway.
- (4) Remove the 2 screws on the strainer valve stay. (Photos 10-1, 10-4 and 10-6)
- (5) Remove the G1" nut using 2 spanners: one to hold the strainer and the other to turn the G1" nut. (Photos 10-1, 10-4 and 10-6)
 - When reinstalling the G1" nut, use new G1" gasket.
- (6) Detach the quick connection. (Photos 10-1, 10-4 and 10-6)
 - When reinstalling the quick connection, use new O-ring.
 - Refer to Procedure 16 for how to attach and detach the quick connection.
- (7) Remove the strainer valve stay by removing the 2 screws. (Photos 10-2 and 10-5)
 - Reuse the removed L joint, the strainer valve stay and the strainer valve stay fixing screws.

<Removal of the strainer cover (debris recovery)>

- (4) Remove the cover with 2 spanners: one to hold the strainer valve and the other to turn the cover. (Photos 10-1, 10-4 and 10-6)
 - Be sure to reattach the mesh after washing. (Photo 10-3)
 - When reinstalling the cover, use a new packing.

Photo 10-3

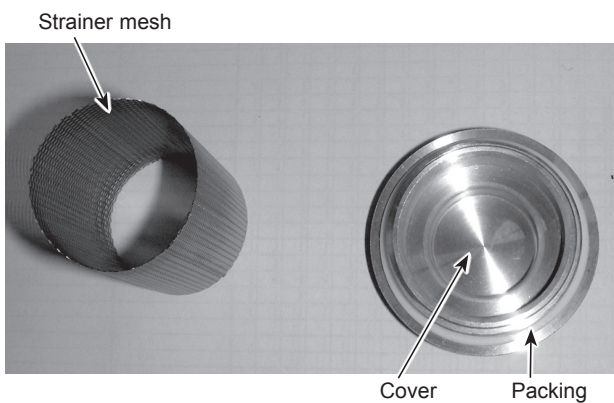
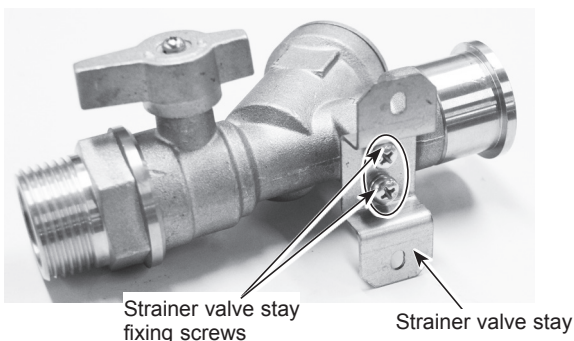

Photo 10-5 (EHS* series)



PHOTOS/ FIGURES

Photo 10-1 (ERS* series)

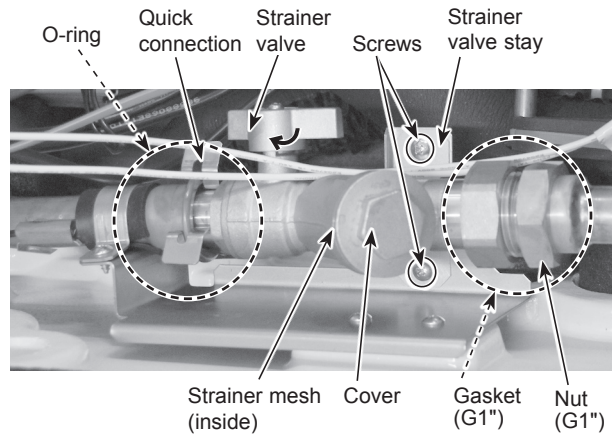

Photo 10-2 (ERS* series)

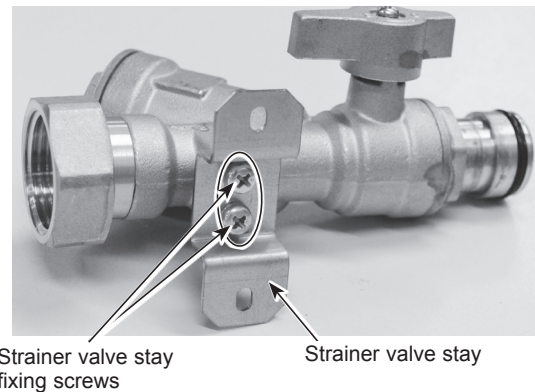

Photo 10-4 (EHS* series)

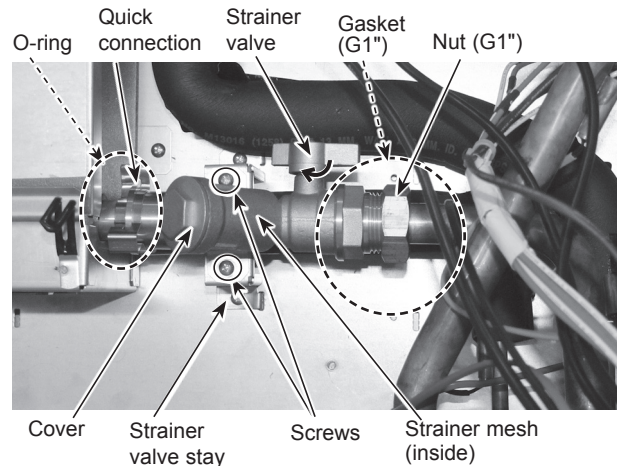
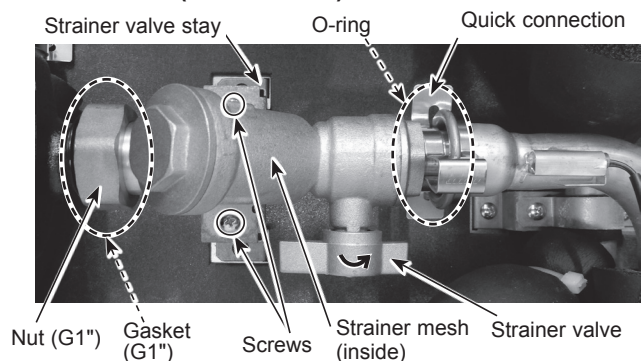

Photo 10-6 (E*PX series)



DISASSEMBLY PROCEDURE

11. How to remove the manometer/ pressure relief valve/ air vent (automatic)

- (1) Remove the front panel. (Refer to Procedure 1.)
- (2) Swing the control box to the front. (Refer to Procedure 4.)

<Manometer>

- (3) Remove the screw on the manometer cover. (Photo 11-1)
- (4) Hold the sides of the manometer cover, disengage the 2 claws, and remove the manometer with cover. (Photo 11-1)
- (5) Remove the G1/4" nut and feed the capillary tube throughout the hydrobox.
 - When reinstalling the G1/4" nut, use a new G1/4" gasket. (Photos 11-2 and 11-4)
- (6) Remove the manometer from the manometer cover while pressing on the claws. (Photo 11-3)
 - When reinstalling the manometer assembly on the hydrobox beware not to put strain on the root of the capillary tube as the capillary tube is easy to break at the root.

<Pressure relief valve (3 bar)>

- (3) Remove the field piping from the pressure relief valve.
- (4) Remove the manometer by removing the G1/4" nut.
 - When reinstalling the G1/4" nut, use a new G1/4" gasket. (Photo 11-2)
- (5) Remove the pressure relief valve with a flare joint using 2 spanners: one to hold the flare joint and the other to turn the flare nut. (Photo 11-2)
- (6) Remove the flare joint from the pressure relief valve using 2 spanners: one to hold the flare joint and the other to turn the pressure relief valve. (Photo 11-5)
- (7) Eliminate loctite on the thread surfaces using remover. (Photo 11-5)
 - Before reinstallation, apply loctite over the thread surface on the pressure relief valve.
 - For more details about the loctite and the remover, refer to page 79.
 - Suitable drain pipe work should be attached to pressure relief valve (3 bar).
 - Make sure to carry out check (turn the cap) on pressure relief valve (3 bar).

PHOTOS/ FIGURES

Photo 11-1

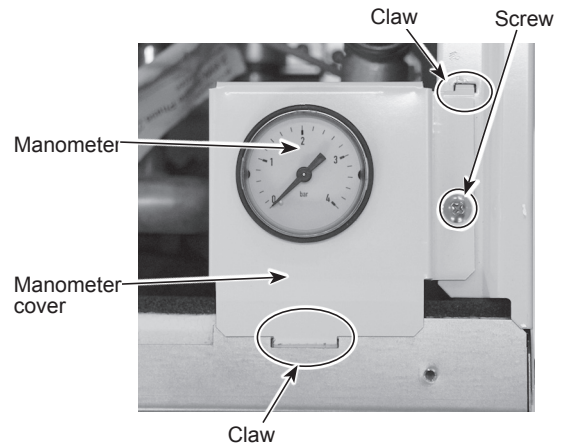

Photo 11-2 (E*S* series)

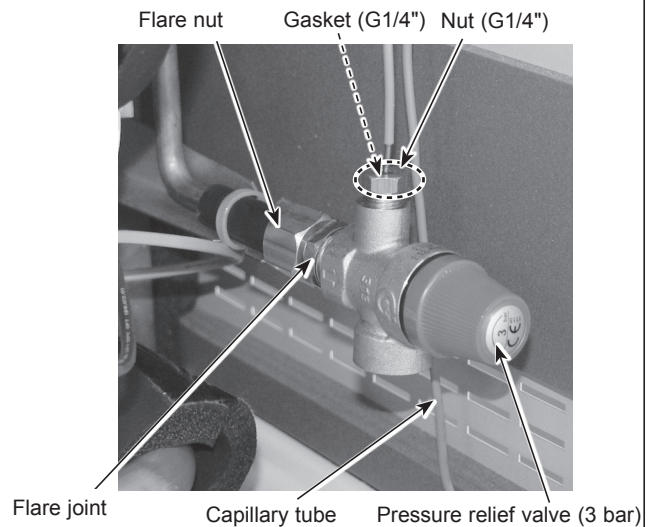

Photo 11-3

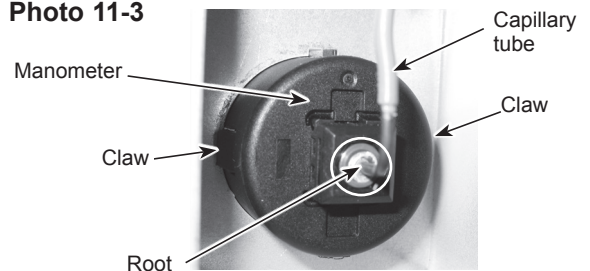

Photo 11-4 (E*PX series)

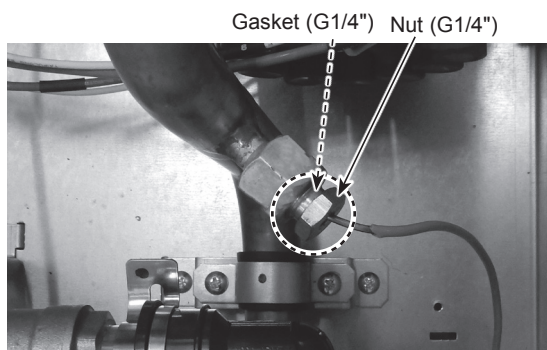
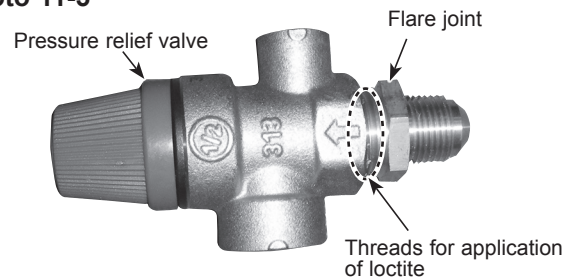

Photo 11-5



DISASSEMBLY PROCEDURE

11. How to remove the manometer/ pressure relief valve/ air vent (automatic) (Continued)

<Pressure relief valve (5 bar)>

- (3) Remove the right side panel.
- (4) Remove the band at the base of the pressure relief valve (5 bar).
- (5) Remove the pressure relief valve with a flare joint using 2 spanners: one to hold the flare joint and the other to turn the flare nut. (Photo 11-6)
- (6) Remove the flare joint from the pressure relief valve using 2 spanners: one to hold the flare joint and the other to turn the pressure relief valve. (Photo 11-6)
- (7) Eliminate loctite on the thread surfaces using remover. (Photo 11-6)
 - Before reinstallation, apply loctite over the thread surface on the pressure relief valve.
 - For more details about the loctite and the remover, refer to page 79.
 - The outlet for the pressure relief valve (5 bar) should be open ended and facing the rear panel.

<Air vent (automatic)>

- (3) Remove the air vent with a flare joint using 2 spanners: one to hold the flare joint and the other to turn the flare nut. (Photo 11-7)
- (4) Remove the flare joint from the air vent using 2 spanners: one to hold the air vent and the other to turn the flare joint. (Photo 11-8)

Photo 11-8

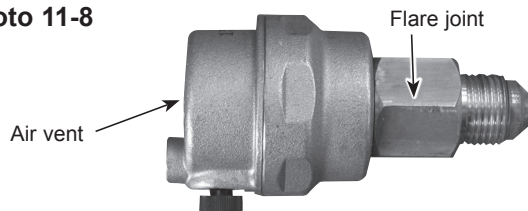

PHOTOS/ FIGURES

Photo 11-6

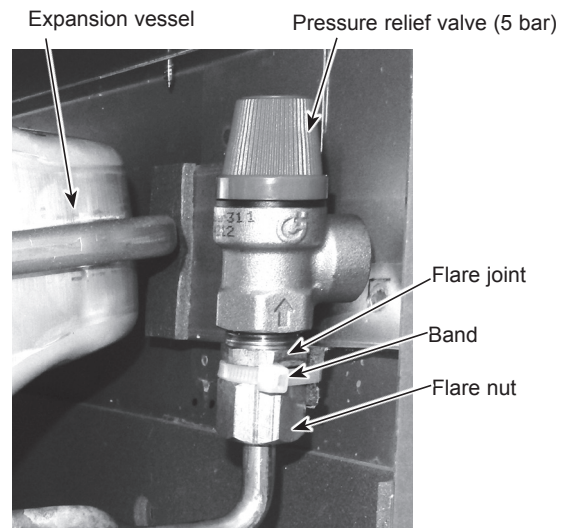
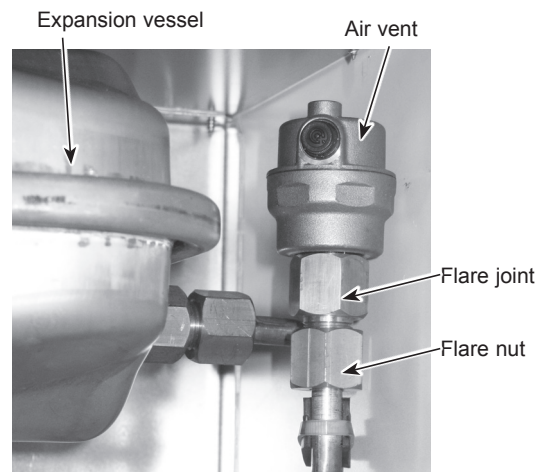

Photo 11-7



12. How to remove the expansion vessel

- (1) Remove the front panel. (Refer to Procedure 1.)
- (2) Swing the control box to the front. (Refer to Procedure 4.)
- (3) Remove the flare nut using 2 spanners: one to hold the flare joint and the other to turn the flare nut. (Photo 12-1)
- (4) Remove the 2 screws on the metal support.
 - Note: To avoid dropping of the expansion vessel, hold the expansion vessel with the metal support by hand when removing the last screw.
- (5) Pull out the metal support. (Photo 12-1)
- (6) Pull out the expansion vessel. (Photo 12-1)
- (7) Remove the flare joint from the expansion vessel. (Photo 12-2)
 - When reinstalling the flare joint, use a new G3/8" gasket.

Note: To avoid dropping of the expansion vessel, hold it securely when removing it.

Photo 12-1

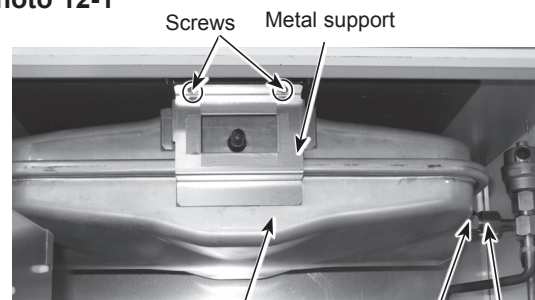
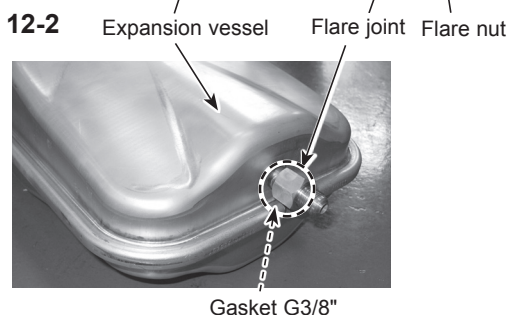

Photo 12-2



DISASSEMBLY PROCEDURE

13. How to remove the drain cock/ the air vent (manual) (primary circuit).

- (1) Remove the front panel. (Refer to Procedure 1.)
- (2) Swing the control box to the front. (Refer to Procedure 4.)
- (3) Remove the drain cock. and the air vent (manual) (primary circuit). (Photo 13)

PHOTOS/ FIGURES

Photo 13 (E*S* series)

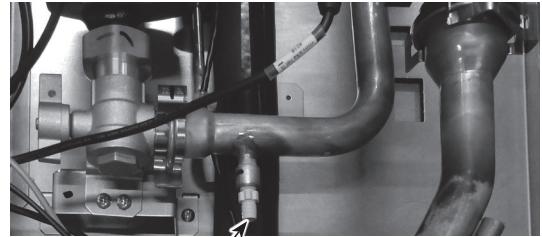

Drain cock

14. How to remove the thermistor <liquid refrigerant temp.> (TH2)/ thermistor <flow water temp. & return water temp.> (THW1, THW2)

- (1) Remove the front panel. (Refer to Procedure 1.)
- (2) Disconnect the CN21 connector and the CNW12 connector on the controller board. (Photo 14-1)
- (3) Release the TH2, THW1 and THW2 lead wires from the cable strap, the fastener and the coated clamp. (Photo 14-1)
- (4) Swing the control box to the front. (Refer to Procedure 4.)
- (5) Remove the thermistors from the thermistor holders. (Photos 14-2, 14-3, 14-4, 14-5 and 14-6)

Photo 14-1

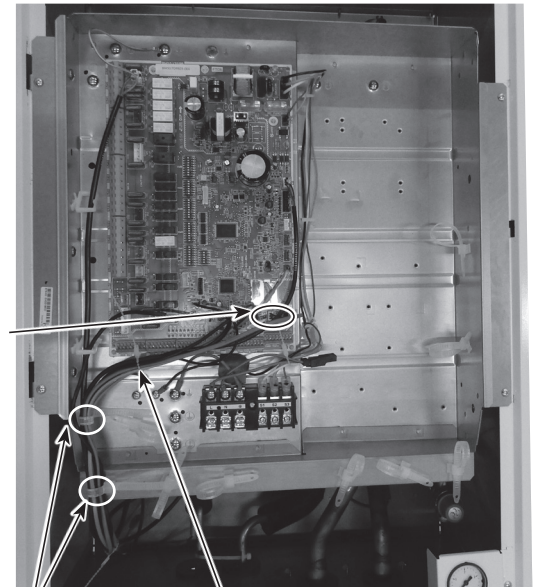

Connectors (CN21) (CNW12)

Cable strap

Fastener

Photo 14-2 (EHS* series)

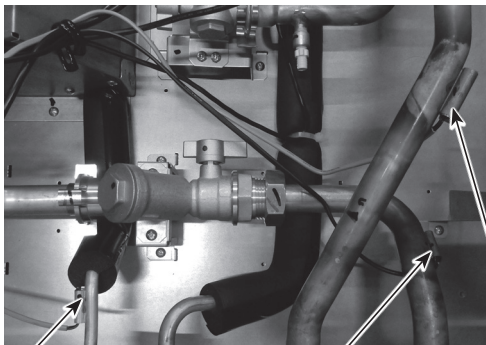

TH2 thermistor

THW2 thermistor

THW1 thermistor

Note: The photo shown is of the EHSD series.

Photo 14-4 (E*SE series)

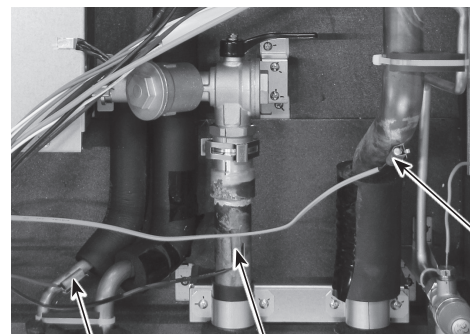

TH2 thermistor

THW2 thermistor

THW1 thermistor

Photo 14-3 (ERS* series)

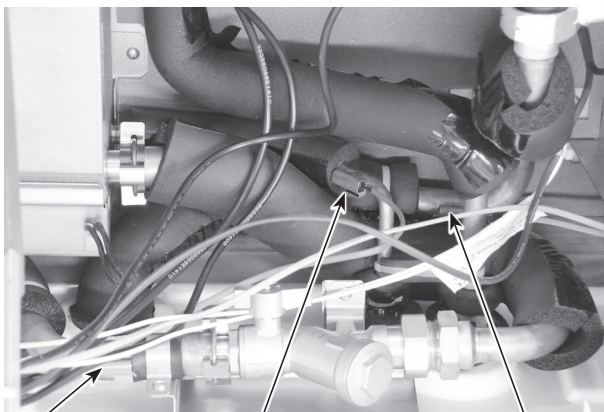

THW2 thermistor

TH2 thermistor

THW1 thermistor

Note: The photo shown is of the ERSC series.

Photo 14-5 (EHPX series)

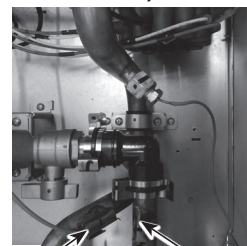

THW1 thermistor

THW2 thermistor

Photo 14-6 (ERPX series)

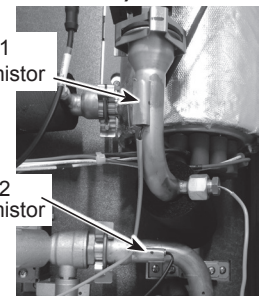

THW1 thermistor

THW2 thermistor

DISASSEMBLY PROCEDURE

15. How to remove the drain pan <ER** series>

- (1) Remove the front panel. (Refer to Procedure 1.)
- (2) Disconnect all the field piping.
- (3) Remove the screw on the manometer cover, then hold the sides of the manometer cover, disengage the 2 claws, and remove the manometer with cover. (Photo 15-1)
- (4) Remove the saddle band and the rubber tube by removing the 2 screws on the saddle band. (Photo 15-2)
 - Reuse the removed saddle band, rubber tube and screws fixing the saddle band and rubber tube.
- (5) Remove the 3 screws each on the cover plate. (Photos 15-3 and 15-4)
- (6) <ERS* series>
 - Remove the cover plate from the base assy. (Photo 15-5)
 - <ERPX series>
 - Remove the 2 cover plates from the base assy. (Photo 15-6)

PHOTOS/ FIGURES

Photo 15-1

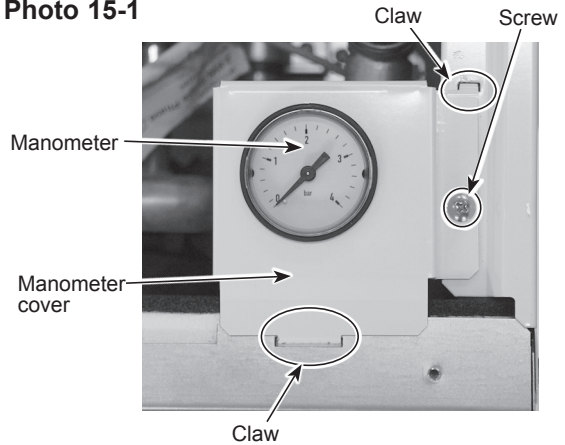

Photo 15-2 (ERS* series)

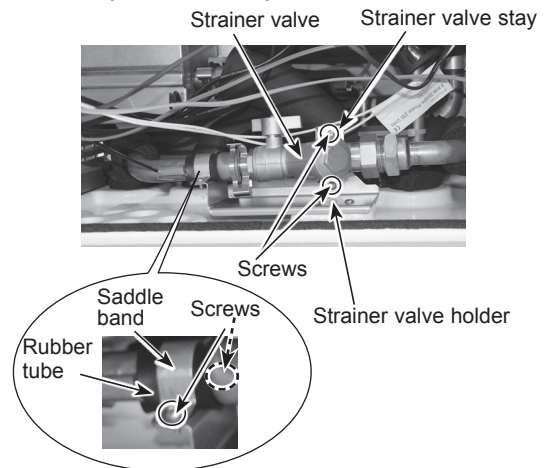

Photo 15-3 (ERS* series)

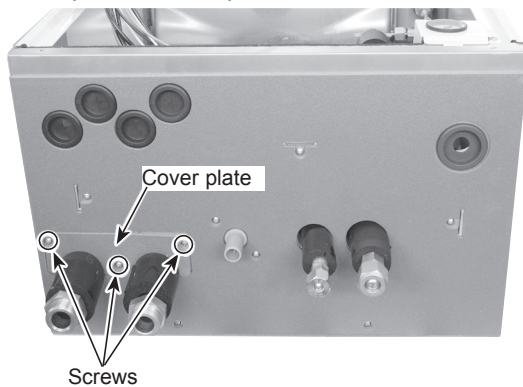

Photo 15-4 (ERPX series)

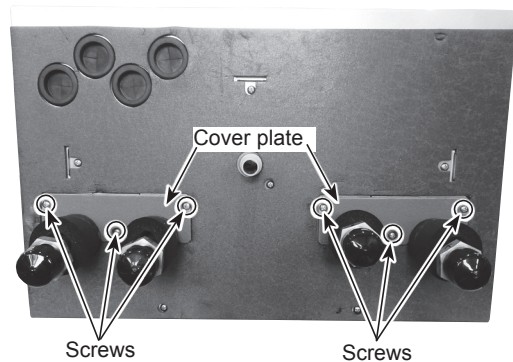

Photo 15-5 (ERS* series)

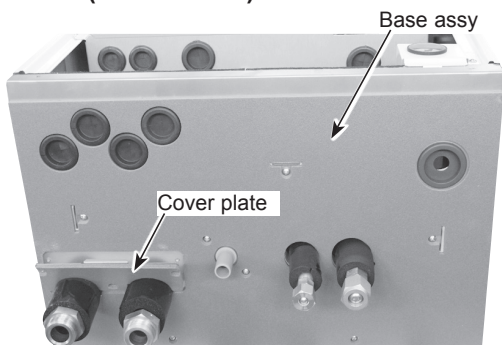
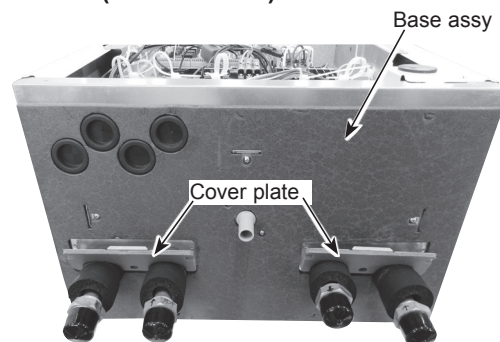

Photo 15-6 (ERPX series)



DISASSEMBLY PROCEDURE

PHOTOS/ FIGURES

15. How to remove the drain pan <ER** series>

- (7) Remove the 3 screws each on the side panel (L, R). Then remove the 2 screws on the base assy. (Photo 15-7)
- (8) Remove the 5 screws on the base assy. (Photo 15-8)
- (9) Remove the drain pan from the base assy. (Photo 15-9)
- (10) <Only ERS* series>
Remove the strainer valve holder by removing the 2 screws from the drain pan. (Photo 15-10)
 - Reuse removed the strainer valve holder and the screws.

Photo 15-7

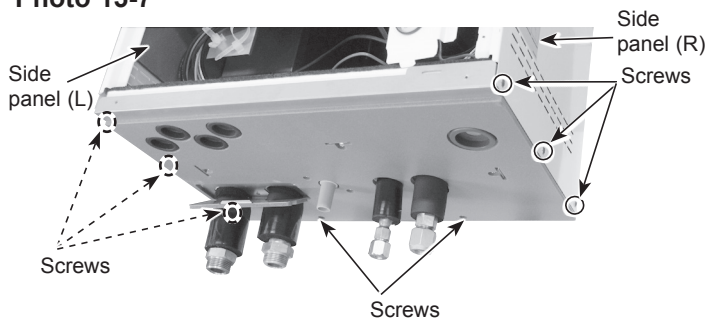

Photo 15-8

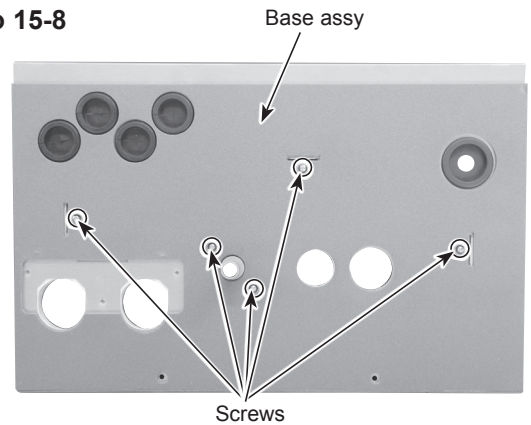

Photo 15-9

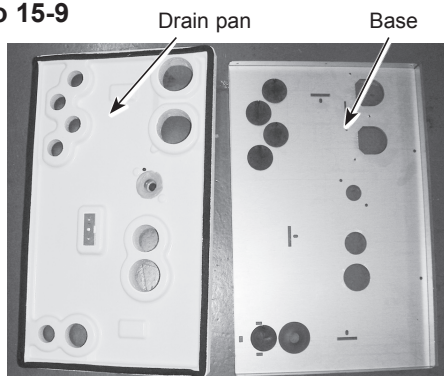
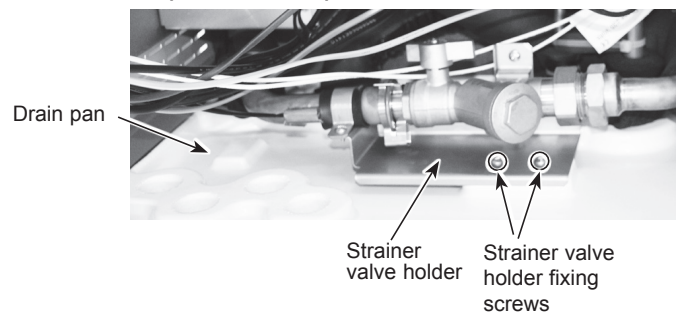

Photo 15-10 (ERS* series)



DISASSEMBLY PROCEDURE

16. How to detach and attach the quick joint

Refer to the following steps when detaching and attaching the quick connection.

- (1) Remove the clip. (Photos 16-1 and 16-2)
- (2) Separate the connected parts to remove the O-ring. (Photo 16-3)
 - Do not reuse the removed O-ring.
 - Wipe off if dirt or foreign matters are found on the sealing surface where the O-ring touches.
- (3) Apply grease on the O-ring using a plastic bag, etc. (Photo 16-4)
- (4) Attach the O-ring to the male part of quick connection. (Photo 16-5)
 - Keep the O-ring free from dirt or foreign matters.
- (5) Connect the male and female parts of the quick connection. (Photo 16-6)
- (6) Attach the clip. (Photo 16-7)
 - Ensure to attach the wider diameter of the clip to the female side. Failure to do so, it may cause water leak at the connected part. (Photo 16-8) (For the same diameter quick connection, following this note is not necessary.)

PHOTOS/ FIGURES

Photo 16-1

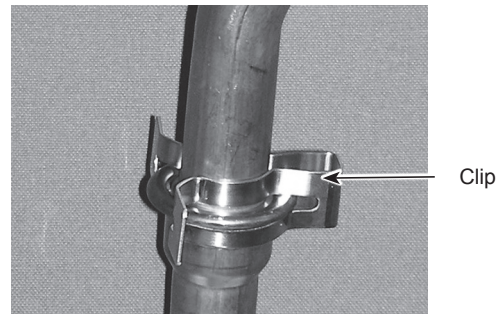

Photo 16-2

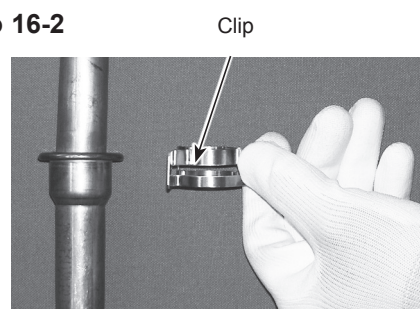

Photo 16-3

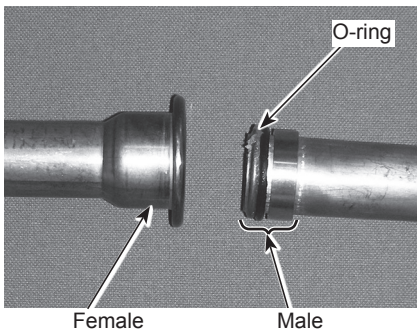

Photo 16-4

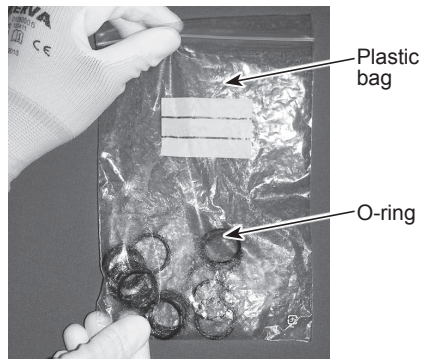

Photo 16-5



Photo 16-6

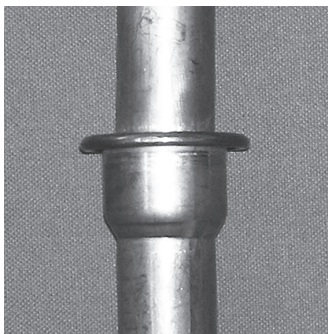

Photo 16-7

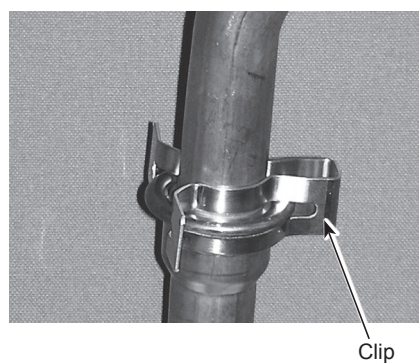
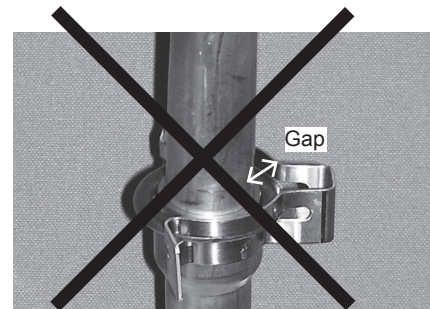

Photo 16-8



Notes on replacing the parts

Replacement of the parts listed below requires the following procedure.

After the parts are removed, eliminate loctite on threads by applying loctite remover, apply new loctite, and then install and tighten the parts to the specified tightening torques below. For details about recommended loctite and loctite remover, refer to Table 11-1, and for details about the replacement parts and their tightening torques, refer to Table 11-2.

Table 11-1

Recommended	Manufacturer	No.	Note
Loctite	Henkel	Loctite 5400	Apply loctite all over from the end of external thread to the second ridge. After installing the parts, fix the parts for at least 30 minutes
Loctite remover	Henkel	Loctite 7200 Gasket Remover	Spray loctite remover over sealant on the threads, let the sealant sit until soft, and then eliminate it with a wire brush.

Note: When using the products above, refer to the appropriate manuals that come with the individual products.

Table 11-2

Part name *1	Recommended tightening torque [Nm] *2
Pressure relief valve (3 bar)	15 ± 1
Pressure relief valve (5 bar)	15 ± 1

*1 For more details about the listed parts, refer to the parts catalogue.

*2 Undertightening and overtightening the parts affect water seal life. Tighten the parts to the appropriate tightening torques.

When installing the parts that are not listed above, observe the tightening torques in accordance with Table 11-3. Always use a new O-ring or gasket.

Table 11-3

Size [inch]	Recommended tightening torque [Nm]	
Gasket	G1/4"	8 ± 1
	G3/8"	15 ± 1
	G1"	42 ± 2
	G1-1/2"	42 ± 2
Packing	Strainer cover	40 ± 2
O-ring	Flow sensor	30 ± 2
	Air vent (Automatic)	15 ± 1
Attached packing	Drain cock (primary circuit)	0.25 ± 0.05
	Air vent (manual)	0.25 ± 0.05
Flare joint (for water circuit parts)		35 ± 2

After the procedure is complete, ensure that no water leaks.

12-1. Refrigerant collecting (pumpdown) for split model systems only

Refer to "Refrigerant collection" in the outdoor unit installation manual or service manual.

12-2. Back-up operation of boiler

Heating operation is backed up by boiler.

For more details, refer to the installation manual of PAC-TH012HT(L)-E.

<Installation & System set up>

1. Set DIP-SW 1-1 to ON "With boiler" and SW2-6 to ON "With Mixing tank".
2. Install the thermistors THWB1 (Flow temp.) *1 on the boiler circuit.
3. Connect the output wire (OUT10: Boiler operation) to the signal input (room thermostat input) on the boiler. *2
4. Install one of the following room temp. thermostats. *3

- Wireless remote controller (option)
- Room temp. thermostat (local supply)
- Main remote controller (remote position)

*1 The boiler temperature thermistor is an optional part.

*2 OUT10 has no voltage across it.

*3 Boiler heating is controlled on/off by the room temp. thermostat.

<Remote controller settings>

1. Go to Service menu > Heat source setting and choose "Boiler" or "Hybrid". *4
2. Go to Service menu > Operation settings > Boiler settings to make detailed settings for "Hybrid" above.

*4 The "Hybrid" automatically switches heat sources between Heat pump (and Electric heater) and boiler.

12-3. Multiple outdoor units control

To realize bigger systems by using multiple outdoor units, up to 6 units of the same model can be connected.

The hydrobox can be used as a sub unit for multiple outdoor unit control.

For more details, refer to the installation manual of PAC-IF071/072B-E.

Check the model name of connecting main unit.

<DIP switch setting>

- Set DIP SW4-1 to ON "Active: multiple outdoor unit control".
- Keep DIP SW4-2 OFF (default setting) (main/sub setting: sub).
- Set DIP SW1-3 to ON when the hydrobox is connected to a DHW tank.

13-1. Annual Maintenance

It is essential that the hydrobox is serviced at least once a year by a qualified individual. Any required parts **MUST** be purchased from Mitsubishi Electric (safety matter). **NEVER** bypass safety devices or operate the unit without them being fully operational.

Note

- Within the first couple of months of installation, remove and clean the hydrobox's strainer plus any additional filter items that are fitted external to the hydrobox. This is especially important when installing on an old/existing pipe work system.
- The pressure relief valve (No. 10 on Figure 3.3) should be checked annually by turning the knob manually so that the medium is discharged, thus cleaning the seal seat.

In addition to annual servicing it is necessary to replace or inspect some parts after a certain period of system operation. Please see tables below for detailed instructions. Replacement and inspection of parts should always be done by a competent person with relevant training and qualifications.

Parts which require regular replacement

Parts	Replace every	Possible failures
Pressure relief valve (PRV) Air vent (Auto/ Manual) Manometer	6 years	Water leakage

Parts which require regular inspection

Parts	Check every	Possible failures
Pressure relief valve (3 bar) Temperature and pressure relief valve	1 year (turning the knob manually)	PRV would be fixed and expansion vessel would burst
Immersion heater	2 years	Earth leakage causing circuit breaker to activate (Heater is always OFF)
Water circulation pump (Primary circuit)	20,000 hrs (3 years)	Water circulation pump failure

Parts which must NOT be reused when servicing

- * O-ring
- * Gasket

Note:

- Always replace the gasket for pump with a new one at each regular maintenance (every 20,000 hours of use or every 3 years).
- No need to inspect pressure relief valve (5 bar) because it does not contact with water unless 3 bar PRV is broken.

13-2. Engineers Forms

Should settings be changed from default, please enter and record new setting in 'Field Setting' column. This will ease resetting in the future should the system use change or the circuit board need to be replaced.

Commissioning/Field settings record sheet

Main remote controller screen		Parameters		Default setting	Field setting	Notes	
Main		Zone1 heating room temp.	10°C to 30°C	20°C			
		Zone2 heating room temp. *1	10°C to 30°C	20°C			
		Zone1 heating flow temp.	20°C to 60°C	45°C			
		Zone2 heating flow temp. *2	20°C to 60°C	35°C			
		Zone1 cooling flow temp. *3	5°C to 25°C	15°C			
		Zone2 cooling flow temp. *3	5°C to 25°C	20°C			
		Zone1 heating compensation curve	-9°C to + 9°C	0°C			
		Zone2 heating compensation curve *2	-9°C to + 9°C	0°C			
		Holiday mode	Active/Non active/Set time	—			
		Forced DHW operation	On/Off	—			
Option		DHW	On/Off/Timer	On			
		Heating/Cooling	On/Off/Timer	On			
		Energy monitor	Consumed electrical energy/Delivered energy	—			
Setting	DHW *4	Operation mode	Normal/Eco *5	Normal			
		DHW max. temp.	40°C to 60°C *6	50°C			
		DHW temp. drop	5°C to 30°C	10°C			
		DHW max. operation time	30 to 120 min	60 min			
		DHW mode restriction	30 to 120 min	30 min			
		DHW recharge	Large/Standard	Large *7			
	Legionella prevention *4	Active	Yes/No	Yes			
		Hot water temp.	60°C to 70°C *6	65°C			
		Frequency	1 to 30 days	15 days			
		Start time	00.00 to 23.00	03.00			
		Max. operation time	1 to 5 hours	3 hours			
		Duration of maximum temp.	1 to 120 min	30 min			
	Heating/ Cooling *3		Zone1 operation mode	Heating room temp./ Heating flow temp./ Heating compensation curve/ Cooling flow temp.	Room temp.		
			Zone2 operation mode *2	Heating room temp./ Heating flow temp./ Heating compensation curve/ Cooling flow temp.	Compensation curve		
	Compensation curve	Hi flow temp. set point	Zone1 outdoor ambient temp.	-30°C to +33°C *8	-15°C		
			Zone1 flow temp.	20°C to 60°C	50°C		
			Zone2 outdoor ambient temp. *2	-30°C to +33°C *8	-15°C		
			Zone2 flow temp. *2	20°C to 60°C	40°C		
		Lo flow temp. set point	Zone1 outdoor ambient temp.	-28°C to +35°C *9	35°C		
			Zone1 flow temp.	20°C to 60°C	25°C		
			Zone2 outdoor ambient temp. *2	-28°C to +35°C *9	35°C		
			Zone2 flow temp. *2	20°C to 60°C	25°C		
		Adjust	Zone1 outdoor ambient temp.	-29°C to +34°C *10	—		
			Zone1 flow temp.	20°C to 60°C	—		
	Zone2 outdoor ambient temp. *2		-29°C to +34°C *10	—			
	Zone2 flow temp. *2		20°C to 60°C	—			
Holiday		DHW *4	Active/Non active	Non active			
		Heating/ Cooling *3	Active/Non active	Active			
		Zone1 heating room temp.	10°C to 30°C	15°C			
		Zone2 heating room temp. *1	10°C to 30°C	15°C			
		Zone1 heating flow temp.	20°C to 60°C	35°C			
		Zone2 heating flow temp. *2	20°C to 60°C	25°C			
		Zone1 cooling flow temp. *3	5°C to 25°C	25°C			
		Zone2 cooling flow temp. *3	5°C to 25°C	25°C			

(Continued to next page.)

Engineers Forms

Commissioning/Field settings record sheet (continued from the previous page)

Main remote controller screen			Parameters		Default setting	Field setting	Notes	
Setting	Initial settings	Language	EN/FR/DE/SV/ES/IT/DA/NL/FI/NO/PT/BG/PL/CZ/RU/TR/SL		EN			
		°C/°F	°C/°F		°C			
Summer time		On/Off		Off				
Temp. display		Room/DHW tank/Room&DHW tank /Off		Off				
Time display		hh:mm/hh:mm AM/AM hh:mm		hh:mm				
Room sensor settings for Zone1		TH1/Main RC/Room RC1-8/"Time/Zone"		TH1				
Room sensor settings for Zone2 *2		TH1/Main RC/Room RC1-8/"Time/Zone"		TH1				
	Room RC zone select *2	Zone1/Zone2		Zone1				
Service menu	Thermistor adjustment	THW1	-10°C to +10°C		0°C			
		THW2	-10°C to +10°C		0°C			
		THW5B	-10°C to +10°C		0°C			
		THW6	-10°C to +10°C		0°C			
		THW7	-10°C to +10°C		0°C			
		THW8	-10°C to +10°C		0°C			
		THW9	-10°C to +10°C		0°C			
		THW10	-10°C to +10°C		0°C			
		THWB1	-10°C to +10°C		0°C			
		Auxiliary settings	Economy settings for pump.	Economy settings	On/Off *11		On	
	Delay (3 to 60 min)					10 min		
	Electric heater (Heating)			Space heating: On (used)/Off (not used)		On		
	Electric heater (DHW) *4		Booster heater	DHW: On (used)/Off (not used)		On		
				Immersion heater	DHW: On (used)/Off (not used)		On	
			Electric heater delay timer (15 to 30 min)		15 min			
			Mixing valve control	Running (10 to 240 sec)		120 sec		
	Interval (1 to 30 min)			2 min				
	Flow sensor *12		Minimum (0 to 100 L/min)		5 L/min			
			Maximum (0 to 100 L/min)		100 L/min			
	Analog output		Interval (1 to 30 min)		5 min			
			Priority (Normal/High)		Normal			
	Pump speed	DHW	Pump speed (1 to 5)		5			
		Heating/Cooling	Pump speed (1 to 5)		5			
	Heat source setting			Standard/Heater/Boiler/Hybrid *13	Standard			
	Heat pump setting	Heat pump flow rate range	Minimum (0 to 100 L/min)		5 L/min			
			Maximum (0 to 100 L/min)		100 L/min			
		Quiet mode	Day (Mon to Sun)		—			
			Time		0:00 - 23:45			
			Quiet level (Normal/ Level1/ Level2)		Normal			
	Operation settings	Heating operation	Flow temp.range *14	Min.temp.(20 to 45°C)		30°C		
				Max.temp.(35 to 60°C)		50°C		
			Room temp. control *15	Mode(Normal/Fast)		Normal		
				Interval(10 to 60 min)		10 min		
Heat pump thermo diff.adjust			On/Off *11		On			
			Lower limit (-9 to -1°C)		-5°C			
		Upper limit (+3 to +5°C)		5°C				
Freeze stat function *16		Outdoor ambient temp. (3 to 20°C) / **		5°C				
Simultaneous operation (DHW/ Heating)		On/Off *11		Off				
		Outdoor ambient temp. (-30 to +10°C) *8		-15°C				
Cold weather function		On/Off *11		Off				
		Outdoor ambient temp. (-30 to -10°C) *8		-15°C				
Boiler operation		Hybrid settings	Outdoor ambient temp. (-30 to +10°C) *8		-15°C			
			Priority mode (Ambient/Cost/CO ₂) *17		Ambient			
			Outdoor ambient temp. rise (+1 to +5 °C)		+3 °C			
		Intelligent settings	Energy price *18	Electricity (0.001 to 999 */kWh)	0.5 */kWh			
				Boiler (0.001 to 999 */kWh)	0.5 */kWh			
	CO ₂ emission		Electricity (0.001 to 999 kg -CO ₂ /kWh)	0.5 kg -CO ₂ / kWh				
			Boiler (0.001 to 999 kg -CO ₂ /kWh)	0.5 kg -CO ₂ / kWh				
	Heat source		Heat pump capacity (1 to 40 kW)		11.2 kW			
			Boiler efficiency (25 to 150%)		80%			
		Booster heater 1 capacity (0 to 30 kW)		2 kW				
		Booster heater 2 capacity (0 to 30 kW)		4 kW				

(Continued to next page.)

Engineers Forms

Commissioning/Field settings record sheet (continued from the previous page)

Main remote controller screen				Parameters		Default setting	Field setting	Notes
	Service menu	Operation settings	Smart grid ready	DHW	On/Off		Off	
					Target temp(+1 to +20°C) / -- (Non active)		--	
				Heating	On/Off		Off	
					Target temp.	Switch-on recommendation (20 to 60°C)	50°C	
				Switch-on command (20 to 60°C)		55°C		
			Cooling	On/Off		Off		
				Target temp.	Switch-on recommendation (5 to 25°C)	15°C		
				Switch-on command (5 to 25°C)		10°C		
			Pump cycles	Heating (On/Off)		On		
				Cooling (On/Off)		On		
				Interval (10 to 120 min)		10 min		
			Floor dry up function	On/Off *11		Off		
				Target temp.	Start&Finish (20 to 60°C)		30°C	
					Max. temp. (20 to 60°C)		45°C	
					Max. temp. period (1 to 20 days)		5 days	
				Flow temp. (Increase)	Temp. increase step (+1 to +10°C)		+5°C	
					Increase interval (1 to 7 days)		2 days	
				Flow temp. (Decrease)	Temp. decrease step (-1 to -10°C)		-5°C	
					Decrease interval (1 to 7 days)		2 days	
			Summer mode	On/Off		Off		
	Outdoor ambient temp.	Heating ON (4 to 19°C)		10°C				
		Heating OFF (5 to 20°C)		15°C				
	Judgement time	Heating ON (1 to 48 hours)		6 hours				
		Heating OFF (1 to 48 hours)		6 hours				
	Forced heating ON (-30 to 10°C)		5 °C					
	Energy monitor settings	Electric heater capacity	Booster heater 1 capacity	0 to 30 kW		2 kW		
			Booster heater 2 capacity	0 to 30 kW		4 kW		
			Immersion heater capacity	0 to 30 kW		0 kW		
			Analog output	0 to 30 kW		0 kW		
		Delivered energy adjustment		-50 to +50%		0%		
		Water pump input	Pump 1	0 to 200 W or ***(factory fitted pump)		***		
			Pump 2	0 to 200 W		0 W		
			Pump 3	0 to 200 W		0 W		
			Pump 4 *7	0 to 200 W		72 W		
		Electric energy meter *19		0.1/1/10/100/1000 pulse/kWh		1000 pulse/kWh		
		Heat meter *19		0.1/1/10/100/1000 pulse/kWh		1000 pulse/kWh		
		External in-put settings	Demand control (IN4)		Heat source OFF/Boiler operation		Boiler operation	
			Outdoor thermostat (IN5)		Heater operation/Boiler operation		Boiler operation	
		Thermo ON output		Zone1/Zone2/Zone1&2		Zone1&2		

*1 The settings related to Zone2 can be switched only when 2-zone temperature control or 2-zone valve ON/OFF control is active.

*2 The settings related to Zone2 can be switched only when 2 Zone temperature control is enabled (when DIP SW2-6 and SW 2-7 are ON).

3 Cooling mode settings are available for ERS model only.

*4 Only available if DHW tank present in system.

*5 When the hydrobox is connected with a PUMY-P outdoor unit, the mode is fixed to "Normal".

*6 For the model without both booster and immersion heater, it may not reach the set temperature depending on the outside ambient temperature.

*7 This setting is valid for only cylinder units.

*8 The lower limit is -15°C depending on the connected outdoor unit.

*9 The lower limit is -13°C depending on the connected outdoor unit.

*10 The lower limit is -14°C depending on the connected outdoor unit.

*11 On: the function is active; Off: the function is inactive.

*12 Do not change the setting since it is set according to the specification of flow sensor attached to the hydrobox.

*13 When DIP SW1-1 is set to OFF "WITHOUT Boiler" or SW2-6 is set to OFF "WITHOUT Mixing tank", neither Boiler nor Hybrid can be selected.

*14 Valid only when operating in Heating room temperature.

*15 When DIP SW5-2 is set to OFF, the function is active.

*16 If asterisk (**) is chosen freeze stat function is deactivated. (i.e. primary water freeze risk)

*17 When the hydrobox is connected with a PUMY-P outdoor unit, the mode is fixed to "Ambient".

18 "" of "kWh" represents currency unit (e.g. € or £ or the like)

*19 The default setting is 1 pulse/kWh depending on the connected indoor unit.



13-3. Annual Maintenance Log Book

Contractor name		Engineer name	
Site name		Site number	

Hydrobox maintenance record sheet

Warranty number		Model number	
		Serial number	

No.	Mechanical	Frequency	Notes
1	Isolate and drain hydrobox, remove mesh from internal strainer clean and replace.		
2	Open the pressure relief valve, check for unrestricted discharge to the tundish and that the valve reseats correctly. Check there are no blockages in the tundish and associated pipe work.		
3	Drop the primary/heating system pressure to zero check and if necessary top up the expansion relief vessel (1 bar). Air valve of expansion vessel is TR-412.		
4	Check and if necessary top up the concentration of anti-freeze/inhibitor (if used in the system).		
5	Top up the primary/heating system using an appropriate filling loop and re-pressurise to 1 bar.		
6	Heat system and check pressure does not rise above 3 bar and no water is released from the safety valves.		
7	Release any air from the system.		

Refrigerant models only		Frequency	Notes
1	Refer to outdoor unit manual.		

Electrical		Frequency	Notes
1	Check condition of cables.		
2	Check rating and fuse fitted on the electricity supply.		

Controller		Frequency	Notes
1	Check field settings against factory recommendations.		
2	Check battery power of wireless thermostat and replace if necessary.		

Outdoor heat pump unit maintenance record sheet

Model number		Serial number	
--------------	--	---------------	--

No.	Mechanical	Frequency	Notes
1	Inspect grill, heat exchanger fins and air inlet for trapped debris/damage.		
2	Check condensate drain provision.		
3	Check integrity of water pipe work and insulation.		
4	Check all electrical connections.		
5	Check and record the operation voltage.		

All the above checks should be carried out once a year.

Note:

Within the first couple of months of installation, remove and clean the hydrobox's strainer mesh plus any that are fitted external to the hydrobox. This is especially important when installing on an existing system.

In addition to annual servicing it is necessary to replace or inspect some parts after a certain period of system operation. Please see tables below for detailed instructions. Replacement and inspection of parts should always be done by a competent person with relevant training and qualifications.

Parts which require regular replacement

Parts	Replace every	Possible failures
Pressure relief valve (3 bar) Air vent (Auto/ Manual) Drain cock (Primary circuit) Manometer	6 years	Water leakage

Parts which require regular inspection

Parts	Check every	Possible failures
Pressure relief valve (3 bar)	1 year (turning the knob manually)	PRV would be fixed and expansion vessel would burst
Water circulation pump	20,000 hrs (3 years)	Water circulation pump failure

Parts which must NOT be reused when servicing

- * O-ring
- * Gasket

Note:

- Always replace the gasket for pump with a new one at each regular maintenance (every 20,000 hours of use or every 3 years).
- Make sure to carry out annual check (turn the cap) on 3 bar PRV. This is not required for 5 bar PRV.



mitsubishi electric corporation

HEAD OFFICE: TOKYO BUILDING, 2-7-3, MARUNOUCHI, CHIYODA-KU, TOKYO 100-8310, JAPAN

©Copyright 2019 MITSUBISHI ELECTRIC CORPORATION
Issued: Oct. 2020 No. OCH712 REVISED EDITION-C
Issued: Apr. 2020 No. OCH712 REVISED EDITION-B
Issued: Feb. 2020 No. OCH712 REVISED EDITION-A
Published: Oct. 2019 No. OCH712
Made in Japan

Specifications are subject to change without notice.